

# Eastbrook

Affordable Luxury

• new products here •

ISSUE R13

[www.eastbrooktrade.com](http://www.eastbrooktrade.com)

**New**  
Models &  
Colours Inside



# The RADIATOR COLLECTION



UK Mainland Edition

| October 1st - April 30th 2024

# Welcome to the new Eastbrook Radiator Collection

As you will see, this brochure contains a vast range of radiators suitable for every room in any style of household. We offer sleek designer radiators and functional bathroom towel rails in all different finishes, that will add a touch of flair to your home.



We have tried to ensure that all price and product information is correct at the time of going to print. However, the specifications contained in this catalogue are for information purposes only and are subject to change. Due to our ongoing policy of product development and improvement, all prices, specifications and features are subject to change without prior notice. Errors and omissions excepted.

# Radiator Contents

P 14 - 6 5	The <b>Multirail</b> Range	A <b>huge variety</b> of contemporary towel rails in a <b>wide variety of sizes and colours</b>
P 68 - 7 5	The <b>Dry Element</b> Range	Using <b>modern technology benefits</b> , the Dry Element Range consists of <b>lighter towel rails</b> and <b>energy efficient daily usage</b> .
P 78 - 8 1	The <b>Stainless Steel</b> Range	Whilst retaining the features of a ladder rail, the stainless steel range produces a <b>stylish contemporary look</b> .
P 82 -157	The <b>Designer</b> Range	Our aim is to offer a <b>statement piece radiator</b> that allows maximum space to keep towels warm. In the designer range you can find a huge variety of towel rail styles and radiators using <b>minimalistic, clean designs</b> .
P160 -169	The <b>Compact Panel</b> Range	Offering a selection of approximately <b>200 sizes</b> , you can be confident in discovering the ideal solution for <b>efficient home heating</b> that perfectly matches your space.
P170 -179	The <b>Flat Panel</b> Range	No more heavy and bulky panel radiators! A <b>minimalist cover</b> has been added to towel rail structured radiators and convector panels to produce a <b>great heat output</b> .
P180 -257	The <b>Aluminium</b> Range	A huge variety of <b>contemporary aluminium radiators</b> and towel rails, from flat panel to ladder rail styles <b>to suit any room</b> .
P258 -285	The <b>Traditional</b> Range	Our <b>traditional range</b> of radiators offer character and flair to ensure they fit in with your classic design. Most of these radiator can be <b>powered</b> via <b>dual fuel, single fuel and /or all electric</b> .

P288 -300	<b>Elements</b>	A huge variety <b>elements</b> and <b>valves</b> to allow easy control of your radiators heat output , whilst <b>looking stylish</b> .
P301 -309	<b>Valves</b>	<b>Complete the look with</b> coloured pipe shrouds and vent caps <b>to match your radiator colour</b> .
P310 - 313	<b>Accessories</b>	To <b>add extra functionality</b> , <b>towel hangers &amp; robe hooks</b> make daily life easy when warming towels.

P314 -387	<b>Technical Tables</b>
--------------	-------------------------

P2 - 11	<b>Visual Contents</b>
---------	------------------------

## RAL Colours / Codes The RAL codes for the radiator and valve colours in the radiator section are as follows:

Gloss White\* : RAL 9016  
Matt White\* : RAL 9016 Matt  
Matt Grey\* : RAL 7040 Matt

Matt Cappuccino\* : Special Colour (Closest colour RAL 1019 Matt)  
Matt Cobalt Blue\* : RAL 5013 Matt  
Matt Anthracite\* : Special colour (Closest colour RAL 7016 Matt)

Matt Black\* : RAL 9005 Matt

\*Touch Up pens for above colours available, please ask sales/technical for more details.  
\*Eastbrook radiator colour swatch contains these colours, please don't forget to ask for your copy.

# Towel Rails & Radiators

## MULTIRAIL RANGE

P12-65



**Wendover Straight Chrome**  
P14-15



**Wendover Straight White**  
P18



**Wendover Curved**  
P16-17 & 19



**Wendover Straight Matt Anthracite** P20-21



**Wendover Straight Matt Black**  
P22-23



**Wendover Straight Brushed Brass** P24-25



**Biava Multirail HV Straight**  
P26-29



**Wingrave Straight Chrome**  
P30-31

Please ask your local showroom or installer for a radiator colour swatch to match your preferred colour.



**Wingrave Straight Gloss White**  
P32-33



**Wingrave Straight Matt White**  
P34-35



**Wingrave Straight Matt Anthracite** P36-37



**Wingrave Straight Matt Black**  
P38-39



**Wingrave Straight Matt Grey & Matt Cobalt Blue** P40-41



**Wingrave Curved**  
P42-43



**Biava Multirail Straight & Curved**  
P44-45



**Westward Straight**  
P46-47

# Towel Rails & Radiators

## MULTIRAIL RANGE P12-65



**Rion Multirail**  
P48-49



**Tuscan White & Chrome**  
P50



**Biava Round**  
P51



**Corinium Round**  
P52-53



**Tuscan Round**  
P54-55



**Biava Tube On Tube Chrome**  
P56



**Biava Square**  
P57



**Tuscan Square Multirail**  
P58-59



**Tuscan Square**  
P60-61



**Launton**  
P62-63



**Haddenham**  
P64-65

**RADIATOR KEY**  
Directional Size Availability



Horizontal  
Sizes



Vertical  
Sizes

## DRY ELEMENT RANGE P66-75



**Derwent Aluminium Dry Element**  
P68-69



**Biava Dry Element Straight**  
P70-71



**Loddon Dry Element**  
P72-73



**Kennet Dry Element**  
P74

# Towel Rails & Radiators

## STAINLESS STEEL RANGE

P76-81



**Emsbury Dry Element**  
P75

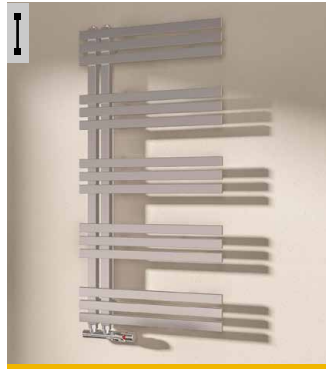

**Rizano**  
P78



**Violla**  
P79



**Biava Flat**  
P80

## DESIGNER RANGE

P82-157



**Ascona**  
P81



**Warrington Type 10**  
P84-85



**Warrington Type 20**  
P86-87



**Leonardo**  
P88



**Staverton Tube On Tube Straight**  
P89



**Staverton Tube On Tube Curved**  
P90



**Biava Corinium**  
P91



**Defford**  
P92-93



**Staverton**  
P94



**Mezzo Tondo**  
P95



**Pesaro**  
P95



**Santero**  
P96-97

# Towel Rails & Radiators

DESIGNER RANGE

P82-157



**Hurley Towel Rail**  
P98-101



**Helmsley Towel Rail**  
P102-103



**Platani**  
P104-105



**Reinbach**  
P106-107



**Marlow**  
P108-109



**Marlow E-Style**  
P110-111



**Conwy**  
P112



**Portchester**  
P113

Please ask your local showroom or installer for a radiator colour swatch to match your preferred colour.



**Lambourne**  
P114-115



**Murano Vertical**  
P116



**Murano Horizontal**  
P117

**RADIATOR KEY**  
Directional Size Availability

Horizontal Sizes      Vertical Sizes



**Ryton Towel Rail**  
P118



**Kenilworth Towel Rail**  
P119



**Loxley Towel Rail**  
P120



**Eshton Towel Rail**  
P121

# Towel Rails & Radiators

**DESIGNER RANGE** **P82-157**



**Rubano Vertical & Horizontal**  
P122-123



**Rowsham Vertical & Horizontal**  
P124-126



**Rowsham Towel Rail**  
P127



**Tunstall Vertical**  
P128-129



**Tunstall Horizontal**  
P130



**Tunstall Towel Rail**  
P131



**Tunstall Double Vertical**  
P132-133



**Tunstall Double Horizontal**  
P134-135

Please ask your local showroom or installer for a radiator colour swatch.



**Tunstall Double Towel Rail**  
P136



**Tunstall Mirror**  
P137



**Tunstall Double Mirror**  
P137



**Deddington Vertical**  
P138-139



**Deddington Horizontal**  
P140-141



**Deddington Towel Rail**  
P142-143



**Addington Type 10 Vertical & Horizontal**  
P144-147



**Addington Type 10 Towel Rail**  
P148



# Towel Rails & Radiators

## DESIGNER RANGE P82-157



Addington Type 20 Vertical & Horizontal P150-153



Addington Type 21 Radiator P154



Addington Type 22 Radiator P155



Addington Type 20 Towel Rail P156

## COMPACT PANEL RANGE P158-169



Addington Type 21 Towel Rail P157



Type 11 Compact Panel P160



Type 21 Compact Panel P161



Type 22 Compact Panel P162



Type 11, 21 & 22 Compact Panel Matt Anthracite P163



Type 11, 21 & 22 Compact Panel Matt Black P164



Flat Cover Plates P166

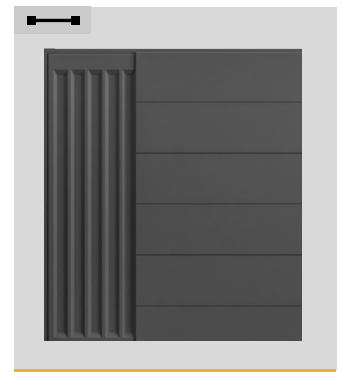

Flat Cover Plates with Lines P167

## FLAT PANEL RANGE P170-179

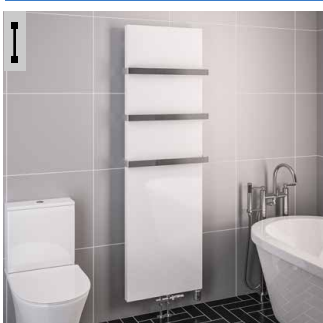

Wingrave Flat Panel P172-175



Type 11 Flat Panel P176-177



Type 22 Flat Panel P178-179

### RADIATOR KEY

Directional Size Availability



Horizontal Sizes



Vertical Sizes

# Towel Rails & Radiators

## ALUMINIUM RANGE

P180-257



**Mersey Vertical**  
P182-183



**Trent Vertical**  
P184-185



**Addington Aluminium Type 10**  
P186-189



**Addington Aluminium Type 20**  
P190-193



**Charlton Vertical**  
P194-195



**Charlton Horizontal**  
P196



**Withington Vertical**  
P198-199



**Withington Horizontal**  
P200

Please ask your local showroom or installer for a radiator colour swatch to match your preferred colour.



**Malmesbury Vertical**  
P202-203



**Malmesbury Horizontal**  
P204



**Rosano Vertical**  
P206-207



**Rosano Horizontal**  
P208-209



**Peretti Vertical**  
P212-213



**Peretti Horizontal**  
P214-215



**Sandhurst Vertical**  
P218-219



**Sandhurst Horizontal**  
P220

# Towel Rails & Radiators

## ALUMINIUM RANGE

P180-257



**Berkeley Horizontal**  
P221



**Tordino Vertical**  
P222-223



**Tordino Horizontal**  
P224



**Guardia Vertical**  
P226-227



**Guardia Horizontal**  
P228-229



**Hadleigh Vertical**  
P230-231



**Hadleigh Horizontal**  
P232-233



**Vesima Vertical**  
P234-235



**Vesima Horizontal**  
P236-237



**Preston Vertical**  
P238-239



**Berlini Vertical**  
P240-241



**Fairford Vertical**  
P242-243



**Fairford Horizontal**  
P244-245



**Burford Vertical**  
P246-247



**Burford Horizontal**  
P248-249

### RADIATOR KEY

Directional Size Availability



Horizontal  
Sizes



Vertical  
Sizes

# Towel Rails & Radiators

## ALUMINIUM RANGE

P180-257



**Kelmescott Vertical & Horizontal**  
P250-253



**Witney Vertical & Horizontal**  
P254-255



**Pelago Towel Rail**  
P256



**Velor Towel Rail**  
P257

## TRADITIONAL RANGE

P258-285



**Windrush**  
P260



**Stour**  
P261-263



**Painswick**  
P264



**Frome**  
P264



**Sherbourne**  
P265



**Avon**  
P266



**Isbourne**  
P267



**Isbourne**  
P267



**Imperia 2 Column**  
P268-270



**Imperia 3 Column**  
P271-273



**Rivassa 2 Column**  
P274-277



**Rivassa 2 Column**  
P274-277

# Towel Rails & Radiators

## TRADITIONAL RANGE

P258-285



Rivassa 3 Column  
P278-281



Rivassa 3 Column  
P278-281



Rivassa 4 Column  
P282-283



Rivassa 4 Column  
P282-283



Leadon  
P284



Thames  
P284



Coln  
P285



Twyver  
P285

## ACCESSORIES

P286-313

Elements  
P288-300



Radiator Valves  
P301-309



Multirail Towel Hangers  
P310



Radiator Robe Hooks  
P310



Pipe Shrouds  
P311



Multi-Purpose Towel Hangers  
P312



Radiator Vent Caps  
P313



Technical Section  
P314-387

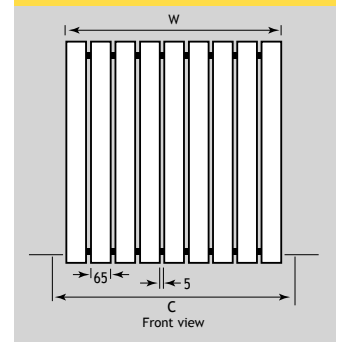

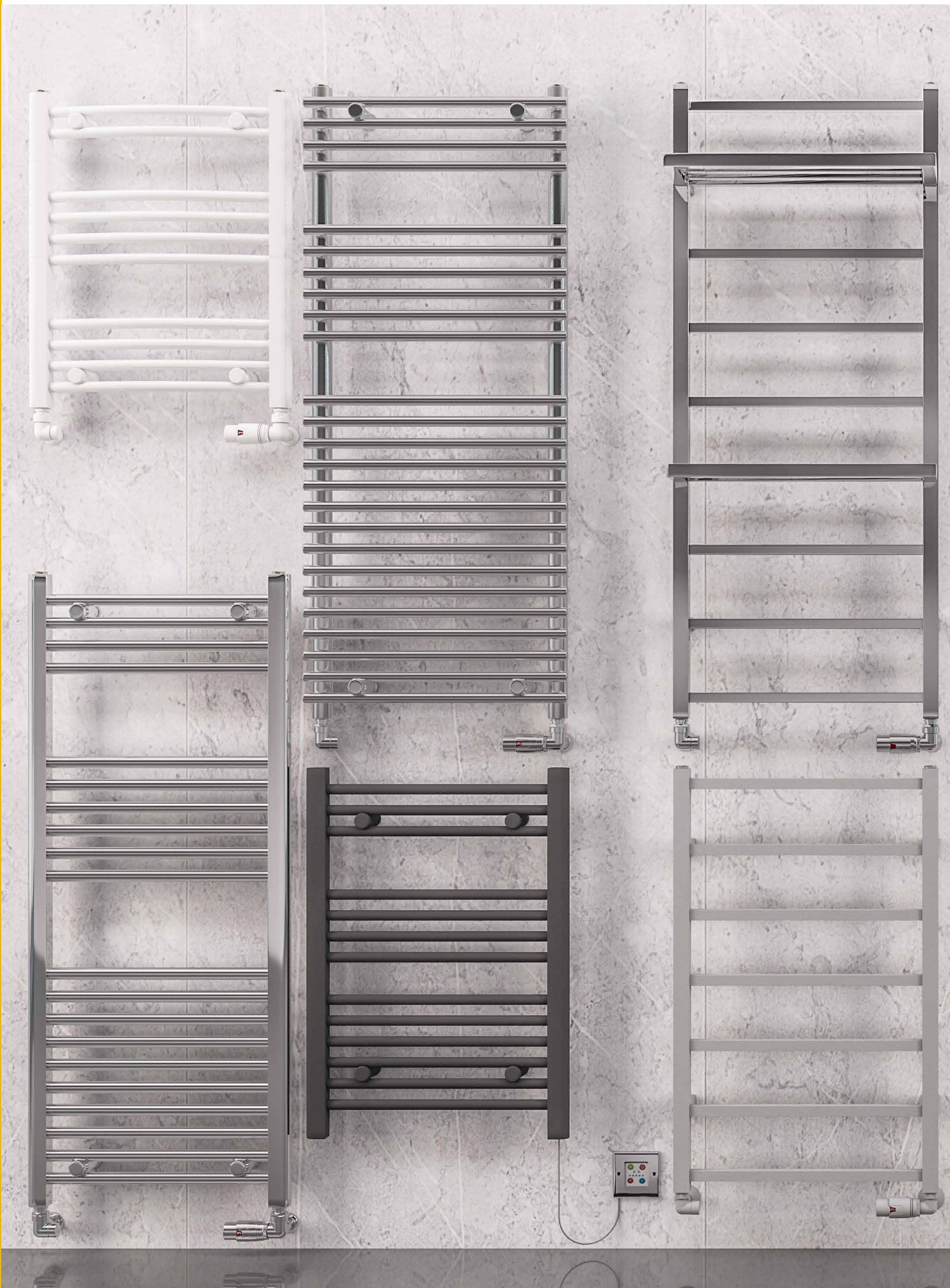

## Sub Section

# Multirail Range

### Contents

Wendover Straight, Chrome - <b>NEW SIZES</b>	14-15
Wendover Curved, Chrome	16-17
Wendover Straight, Gloss White - <b>NEW SIZES</b>	18
Wendover Curved, Gloss White	19
Wendover Straight, Matt Anthracite - <b>NEW SIZES</b>	20-21
Wendover Straight, Matt Black - <b>NEW PRODUCT</b>	22-23
Wendover Straight, Brushed Brass - <b>NEW SIZES</b>	24-25
Biava Multirail HV Straight, Available in 5 colours	26-29
Wingrave Straight, Chrome	30-31
Wingrave Straight, Gloss White	32-33
Wingrave Straight, Matt White	34-35
Wingrave Straight, Matt Anthracite	36-37
Wingrave Straight, Matt Black	38-39
Wingrave Straight, Matt Grey	40
Wingrave Straight, Matt Cobalt Blue	41
Wingrave Curved, Chrome	42
Wingrave Curved, Gloss White	43
Biava Multirail Straight, Gloss White	44
Biava Multirail Straight, Chrome	44
Biava Multirail Curved, Gloss White	45
Biava Multirail Curved, Chrome	45
Westward Straight, Gloss White & Chrome	46-47
Rion Multirail, Available in 4 colours	48-49
Tuscan, Gloss White & Chrome	50
Biava Round, Gloss White & Chrome	51
Corinium Round, Available in 5 colours	52-53
Tuscan Round, Available in 5 colours	54-55
Biava Tube on Tube, Chrome	56
Biava Square, Chrome	57
Tuscan Square Multirail, Available in 4 colours	58-59
Tuscan Square, Available in 5 colours	60-61
Launton, Available in 3 colours	62-63
Haddenham, Available in 3 colours	64-65



# Multirail Range

## WENDOVER - STRAIGHT, CHROME



Pictured 41.0245 Chrome



Pictured 41.0015 Chrome

A modern ladder towel rail, available in a vast array of sizes including 600mm high by 1200mm wide, as pictured above, which is ideal for under-window situation. The Wendover range is available in chrome, brushed brass, gloss white and matt anthracite, along with matching radiator valves and pipe shrouds.

### Wendover - Straight Chrome 360mm Height

Size H x W	Watts	BTU	Element Output	Element Type	Code	£ Ex VAT	£ Inc VAT
360 x 400mm	112	347	N/A	N/A	41.0267	74.00	88.80

### Wendover - Straight Chrome 600mm Height

Size H x W	Watts	BTU	Element Output	Element Type	Code	£ Ex VAT	£ Inc VAT
600 x 300mm	155	529	100W	A, A+, D, E, F, G	41.0085	92.00	110.40
600 x 400mm	190	648	100W	A, A+, D, E, F, G	41.0082	100.00	120.00
600 x 500mm	225	768	100W	A, A+, D, E, F, G	41.0083	107.00	128.40
600 x 600mm	260	887	150W	A, A+, D, E, F, G	41.0084	116.00	139.20
600 x 750mm	313	1068	150W	A, A+, D, E, F, G	41.0076	131.00	157.20
600 x 1000mm	401	1368	150W	A, A+, D, E, F, G	41.0244	195.00	234.00
600 x 1200mm	472	1610	150W	A, A+, D, E, F, G	41.0245	217.00	260.40

Warranty

**5**

Year

Diameter (Ø)

**22**

MM Bars

Heating

All Electric

Dual-Fuel

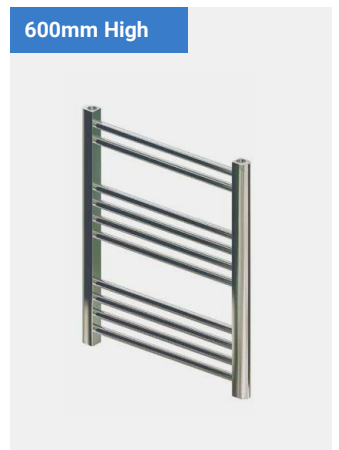



# Multirail Range

## WENDOVER - STRAIGHT, CHROME

### Wendover - Straight Chrome 800mm Height

Size H x W	Watts	BTU	Element Output	Element Type	Code	£ Ex VAT	£ Inc VAT
800 x 300mm	211	720	100W	A, A+, D, E, F, G	41.0086	112.00	134.40
800 x 400mm	260	887	150W	A, A+, D, E, F, G	41.0001	119.00	142.80
800 x 500mm	309	1054	150W	A, A+, D, E, F, G	41.0003	128.00	153.60
800 x 600mm	359	1225	150W	A, A+, D, E, F, G	41.0005	136.00	163.20
800 x 750mm	433	1477	150W	A, A+, D, E, F, G	41.0077	166.00	199.20

### Wendover - Straight Chrome 1000mm Height

Size H x W	Watts	BTU	Element Output	Element Type	Code	£ Ex VAT	£ Inc VAT
1000 x 300mm	251	856	150W	A, A+, D, E, F, G	41.0087	130.00	156.00
1000 x 400mm	308	1051	150W	A, A+, D, E, F, G	41.0007	136.00	163.20
1000 x 500mm	364	1242	150W	A, A+, D, E, F, G	41.0009	146.00	175.20
1000 x 600mm	421	1436	150W	A, A+, D, E, F, G	41.0011	156.00	187.20
1000 x 750mm	506	1726	300W	A, A+, D, E, F, G	41.0078	191.00	229.20

### Wendover - Straight Chrome 1200mm Height

Size H x W	Watts	BTU	Element Output	Element Type	Code	£ Ex VAT	£ Inc VAT
1200 x 300mm	308	1051	150W	A, A+, D, E, F, G	41.0088	153.00	183.60
1200 x 400mm	379	1293	150W	A, A+, D, E, F, G	41.0013	156.00	187.20
1200 x 500mm	450	1535	150W	A, A+, D, E, F, G	41.0015	168.00	201.60
1200 x 600mm	554	1890	300W	A, A+, D, E, F, G	41.0017	185.00	222.00
1200 x 750mm	626	2136	300W	A, A+, D, E, F, G	41.0079	228.00	273.60

### NEW! Wendover - Straight Chrome 1400mm Height

Size H x W	Watts	BTU	Element Output	Element Type	Code	£ Ex VAT	£ Inc VAT
1400 x 300mm	351	1198	150W	A, A+, D, E, F, G	41.0620	173.00	207.60
1400 x 400mm	429	1464	150W	A, A+, D, E, F, G	41.0621	181.00	217.20
1400 x 500mm	507	1730	150W	A, A+, D, E, F, G	41.0622	193.00	231.60
1400 x 600mm	585	1996	300W	A, A+, D, E, F, G	41.0623	209.00	250.80
1400 x 750mm	701	2392	300W	A, A+, D, E, F, G	41.0624	275.00	330.00

### Wendover - Straight Chrome 1600mm Height

Size H x W	Watts	BTU	Element Output	Element Type	Code	£ Ex VAT	£ Inc VAT
1600 x 300mm	406	1385	150W	A, A+, D, E, F, G	41.0089	187.00	224.40
1600 x 400mm	497	1696	300W	A, A+, D, E, F, G	41.0019	195.00	234.00
1600 x 500mm	589	2010	300W	A, A+, D, E, F, G	41.0021	213.00	255.60
1600 x 600mm	681	2324	300W	A, A+, D, E, F, G	41.0023	231.00	277.20
1600 x 750mm	819	2794	450W	A, A+, D, E, F, G	41.0080	287.00	344.40

### Wendover - Straight Chrome 1800mm Height

Size H x W	Watts	BTU	Element Output	Element Type	Code	£ Ex VAT	£ Inc VAT
1800 x 300mm	462	1576	150W	A, A+, D, E, F, G	41.0090	207.00	248.40
1800 x 400mm	568	1938	300W	A, A+, D, E, F, G	41.0025	217.00	260.40
1800 x 500mm	675	2303	300W	A, A+, D, E, F, G	41.0027	240.00	288.00
1800 x 600mm	780	2661	450W	A, A+, D, E, F, G	41.0029	259.00	310.80
1800 x 750mm	940	3207	450W	A, A+, D, E, F, G	41.0081	321.00	385.20

**Round Vent Caps**  
Page 313



**Robe Hooks**  
Page 310

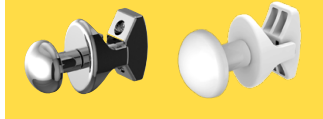

**Towel Hangers**  
Page 310



**Multi-Rail Hangers**  
Page 310



## TECHNICAL INFORMATION

All measurements in Height by Width. Heat output based on  $\Delta T60^{\circ}\text{C}$ . Radiators that are electric only are restricted to the heat output of the elements. Element size can be increased to full capacity of rail if using element type D, E, F or G. (Type F & G Elements suitable for all electric only) For element types see pages 288-300. For matching valves see pages 301-309. For indirect heating systems only. Tappings are approx. 50mm less than the width of the rail and approx. 75-95mm off the wall. Projection from wall 90-110mm. Price includes radiator and wall fixing sets, valves extra.

**Technical Tables & Drawings**  
Page 316-317



# Multirail Range

## WENDOVER - CURVED, CHROME



Technical Tables  
& Drawings  
Page 316-317



Pictured 41.0035 Chrome

A modern ladder towel rail, with a range of sizes available, from 600 x 400mm to 1800 x 750mm. Available in straight and curved options as well as chrome, gloss white and matt anthracite finishes.

### FEATURES

- 22mm diameter horizontal round tubes
  - Tested to BS EN 442 standards
  - 5 Year manufacturer's warranty\*
  - Can be single or dual fuel, or all electric
- \* With conditions

<p>Warranty</p> <p><b>5</b></p> <p>Year</p>	<p>Diameter (Ø)</p> <p><b>22</b></p> <p>MM Bars</p>	<p>Heating</p>	<p>All Electric</p>	<p>Dual-Fuel</p>
---	---	----------------	---------------------	------------------

800mm High



600mm High



# Multirail Range

## WENDOVER - CURVED, CHROME

### Wendover - Curved Chrome 600mm Height

Size H x W	Watts	BTU	Element Output	Element Type	Code	£ Ex VAT	£ Inc VAT
600 x 400mm	190	648	100W	A, A+, D, E, F, G	41.0106	101.00	121.20
600 x 500mm	225	768	100W	A, A+, D, E, F, G	41.0107	109.00	130.80
600 x 600mm	260	887	150W	A, A+, D, E, F, G	41.0108	119.00	142.80
600 x 750mm	313	1068	150W	A, A+, D, E, F, G	41.0100	136.00	163.20

### Wendover - Curved Chrome 800mm Height

Size H x W	Watts	BTU	Element Output	Element Type	Code	£ Ex VAT	£ Inc VAT
800 x 400mm	263	897	150W	A, A+, D, E, F, G	41.0031	124.00	148.80
800 x 500mm	312	1065	150W	A, A+, D, E, F, G	41.0033	130.00	156.00
800 x 600mm	361	1232	150W	A, A+, D, E, F, G	41.0035	139.00	166.80
800 x 750mm	433	1477	150W	A, A+, D, E, F, G	41.0101	174.00	208.80

### Wendover - Curved Chrome 1000mm Height

Size H x W	Watts	BTU	Element Output	Element Type	Code	£ Ex VAT	£ Inc VAT
1000 x 400mm	310	1058	150W	A, A+, D, E, F, G	41.0037	137.00	164.40
1000 x 500mm	367	1252	150W	A, A+, D, E, F, G	41.0039	150.00	180.00
1000 x 600mm	423	1443	150W	A, A+, D, E, F, G	41.0041	158.00	189.60
1000 x 750mm	506	1726	300W	A, A+, D, E, F, G	41.0102	195.00	234.00

### Wendover - Curved Chrome 1200mm Height

Size H x W	Watts	BTU	Element Output	Element Type	Code	£ Ex VAT	£ Inc VAT
1200 x 400mm	382	1303	150W	A, A+, D, E, F, G	41.0043	158.00	189.60
1200 x 500mm	452	1542	150W	A, A+, D, E, F, G	41.0045	177.00	212.40
1200 x 600mm	523	1784	300W	A, A+, D, E, F, G	41.0047	189.00	226.80
1200 x 750mm	626	2136	300W	A, A+, D, E, F, G	41.0103	234.00	280.80

### Wendover - Curved Chrome 1600mm Height

Size H x W	Watts	BTU	Element Output	Element Type	Code	£ Ex VAT	£ Inc VAT
1600 x 400mm	501	1709	300W	A, A+, D, E, F, G	41.0049	203.00	243.60
1600 x 500mm	593	2023	300W	A, A+, D, E, F, G	41.0051	222.00	266.40
1600 x 600mm	685	2337	300W	A, A+, D, E, F, G	41.0053	239.00	286.80
1600 x 750mm	819	2794	450W	A, A+, D, E, F, G	41.0104	296.00	355.20

### Wendover - Curved Chrome 1800mm Height

Size H x W	Watts	BTU	Element Output	Element Type	Code	£ Ex VAT	£ Inc VAT
1800 x 400mm	573	1955	300W	A, A+, D, E, F, G	41.0055	228.00	273.60
1800 x 500mm	678	2313	300W	A, A+, D, E, F, G	41.0057	247.00	296.40
1800 x 600mm	784	2675	450W	A, A+, D, E, F, G	41.0059	266.00	319.20
1800 x 750mm	940	3207	450W	A, A+, D, E, F, G	41.0105	332.00	398.40

### Round Vent Caps

Page 313



### Robe Hooks

Page 310



### Radiator Valves

Page 301-309



## TECHNICAL INFORMATION

All measurements in Height by Width. Heat output based on  $\Delta T60^{\circ}\text{C}$ . Radiators that are electric only are restricted to the heat output of the elements. Element size can be increased to full capacity of rail if using element type D, E, F or G. (Type F & G Elements suitable for all electric only) For element types see pages 288-300. For matching valves see pages 301-309. For indirect heating systems only. Tappings are approx. 50mm less than the width of the rail and approx. 70mm off the wall. Price includes radiator and wall fixing sets, valves extra.

### 1000mm High



### 1200mm High



### 1600mm High



### 1800mm High



# Multirail Range

## WENDOVER - STRAIGHT, GLOSS WHITE



Pictured 41.0028 Gloss White

A modern ladder towel rail, with a range of sizes available including 360 x 400mm to 1800 x 750mm. Available in straight and curved options as well as chrome, gloss white and matt anthracite finishes.

### FEATURES

- 22mm diameter horizontal round tubes
- Tested to BS EN 442 standards
- 5 Year manufacturer's warranty\*
- Can be single or dual fuel, or all electric
- \* With conditions

Technical Tables  
& Drawings  
Page 316-317



### Round Vent Caps

Page 313



### Multi-Rail Hangers

Page 310



### Wendover - Straight Gloss White 360mm Height

Size H x W	Watts	BTU	Element Output	Element Type	Code	£ Ex VAT	£ Inc VAT
360 x 400mm	112	423	N/A	N/A	41.0266	47.00	56.40

### Wendover - Straight Gloss White 600mm Height

Size H x W	Watts	BTU	Element Output	Element Type	Code	£ Ex VAT	£ Inc VAT
600 x 300mm	196	669	100W	A, A+, D, E, F, G	41.0070	56.00	67.20
600 x 400mm	241	822	150W	A, A+, D, E, F, G	41.0067	62.00	74.40
600 x 500mm	285	972	150W	A, A+, D, E, F, G	41.0068	65.00	78.00
600 x 600mm	330	1126	150W	A, A+, D, E, F, G	41.0069	69.00	82.80
600 x 750mm	397	1355	150W	A, A+, D, E, F, G	41.0061	79.00	94.80
600 x 1000mm	510	1740	300W	A, A+, D, E, F, G	41.0246	116.00	139.20
600 x 1200mm	600	2047	300W	A, A+, D, E, F, G	41.0247	125.00	150.00

### Wendover - Straight Gloss White 800mm Height

Size H x W	Watts	BTU	Element Output	Element Type	Code	£ Ex VAT	£ Inc VAT
800 x 300mm	267	911	150W	A, A+, D, E, F, G	41.0071	66.00	79.20
800 x 400mm	330	1126	150W	A, A+, D, E, F, G	41.0002	70.00	84.00
800 x 500mm	394	1344	150W	A, A+, D, E, F, G	41.0004	74.00	88.80
800 x 600mm	457	1559	150W	A, A+, D, E, F, G	41.0006	79.00	94.80
800 x 750mm	551	1880	300W	A, A+, D, E, F, G	41.0062	96.00	115.20

### Wendover - Straight Gloss White 1000mm Height

Size H x W	Watts	BTU	Element Output	Element Type	Code	£ Ex VAT	£ Inc VAT
1000 x 300mm	320	1092	150W	A, A+, D, E, F, G	41.0072	78.00	93.60
1000 x 400mm	392	1338	150W	A, A+, D, E, F, G	41.0008	79.00	94.80
1000 x 500mm	464	1583	150W	A, A+, D, E, F, G	41.0010	84.00	100.80
1000 x 600mm	535	1825	300W	A, A+, D, E, F, G	41.0012	90.00	108.00
1000 x 750mm	643	2194	300W	A, A+, D, E, F, G	41.0063	107.00	128.40

### Wendover - Straight Gloss White 1200mm Height

Size H x W	Watts	BTU	Element Output	Element Type	Code	£ Ex VAT	£ Inc VAT
1200 x 300mm	392	1338	150W	A, A+, D, E, F, G	41.0073	88.00	105.60
1200 x 400mm	482	1645	300W	A, A+, D, E, F, G	41.0014	90.00	108.00
1200 x 500mm	571	1948	300W	A, A+, D, E, F, G	41.0016	96.00	115.20
1200 x 600mm	661	2255	300W	A, A+, D, E, F, G	41.0018	101.00	121.20
1200 x 750mm	796	2716	450W	A, A+, D, E, F, G	41.0064	126.00	151.20

### NEW! Wendover - Straight Gloss White 1400mm Height

Size H x W	Watts	BTU	Element Output	Element Type	Code	£ Ex VAT	£ Inc VAT
1400 x 300mm	444	1515	150W	A, A+, D, E, F, G	41.0625	96.00	115.20
1400 x 400mm	542	1849	300W	A, A+, D, E, F, G	41.0626	101.00	121.20
1400 x 500mm	642	2191	300W	A, A+, D, E, F, G	41.0627	111.00	133.20
1400 x 600mm	740	2525	300W	A, A+, D, E, F, G	41.0628	121.00	145.20
1400 x 750mm	888	3030	450W	A, A+, D, E, F, G	41.0629	152.00	182.40

### Wendover - Straight Gloss White 1600mm Height

Size H x W	Watts	BTU	Element Output	Element Type	Code	£ Ex VAT	£ Inc VAT
1600 x 300mm	516	1761	300W	A, A+, D, E, F, G	41.0074	102.00	122.40
1600 x 400mm	632	2156	300W	A, A+, D, E, F, G	41.0020	109.00	130.80
1600 x 500mm	749	2556	450W	A, A+, D, E, F, G	41.0022	119.00	142.80
1600 x 600mm	867	2958	450W	A, A+, D, E, F, G	41.0024	128.00	153.60
1600 x 750mm	1041	3552	600W	A, A+, D, E, F, G	41.0065	155.00	186.00

### Wendover - Straight Gloss White 1800mm Height

Size H x W	Watts	BTU	Element Output	Element Type	Code	£ Ex VAT	£ Inc VAT
1800 x 300mm	588	2006	300W	A, A+, D, E, F, G	41.0075	116.00	139.20
1800 x 400mm	723	2467	300W	A, A+, D, E, F, G	41.0026	124.00	148.80
1800 x 500mm	856	2921	450W	A, A+, D, E, F, G	41.0028	131.00	157.20
1800 x 600mm	991	3381	600W	A, A+, D, E, F, G	41.0030	141.00	169.20
1800 x 750mm	1193	4071	600W	A, A+, D, E, F, G	41.0066	176.00	211.20

Warranty  
**5**  
Year

Diameter (Ø)  
**22**  
MM Bars

Heating

All Electric

Dual-Fuel

# Multirail Range

## WENDOVER - CURVED, GLOSS WHITE



Pictured 41.0036 Gloss White

A modern ladder towel rail, with a range of sizes available including 600 x 400mm to 1800 x 750mm. Available in straight and curved options as well as chrome, gloss white and matt anthracite finishes.

### FEATURES

- 22mm diameter horizontal round tubes
- Tested to BS EN 442 standards
- 5 Year manufacturer's warranty\*
- Can be single or dual fuel, or all electric
- \* With conditions

**Technical Tables  
& Drawings**  
Page 316-317



### Wendover - Curved Gloss White 600mm Height

Size H x W	Watts	BTU	Element Output	Element Type	Code	£ Ex VAT	£ Inc VAT
600 x 400mm	241	822	150W	A, A+, D, E, F, G	41.0097	63.00	75.60
600 x 500mm	285	972	150W	A, A+, D, E, F, G	41.0098	66.00	79.20
600 x 600mm	330	1126	150W	A, A+, D, E, F, G	41.0099	70.00	84.00
600 x 750mm	397	1355	150W	A, A+, D, E, F, G	41.0091	80.00	96.00

### Wendover - Curved Gloss White 800mm Height

Size H x W	Watts	BTU	Element Output	Element Type	Code	£ Ex VAT	£ Inc VAT
800 x 400mm	333	1136	150W	A, A+, D, E, F, G	41.0032	73.00	87.60
800 x 500mm	396	1351	150W	A, A+, D, E, F, G	41.0034	78.00	93.60
800 x 600mm	459	1566	150W	A, A+, D, E, F, G	41.0036	83.00	99.60
800 x 750mm	551	1880	300W	A, A+, D, E, F, G	41.0092	97.00	116.40

### Wendover - Curved Gloss White 1000mm Height

Size H x W	Watts	BTU	Element Output	Element Type	Code	£ Ex VAT	£ Inc VAT
1000 x 400mm	395	1348	150W	A, A+, D, E, F, G	41.0038	80.00	96.00
1000 x 500mm	467	1593	150W	A, A+, D, E, F, G	41.0040	88.00	105.60
1000 x 600mm	539	1839	300W	A, A+, D, E, F, G	41.0042	91.00	109.20
1000 x 750mm	643	2194	300W	A, A+, D, E, F, G	41.0093	109.00	130.80

### Wendover - Curved Gloss White 1200mm Height

Size H x W	Watts	BTU	Element Output	Element Type	Code	£ Ex VAT	£ Inc VAT
1200 x 400mm	486	1658	300W	A, A+, D, E, F, G	41.0044	91.00	109.20
1200 x 500mm	575	1962	300W	A, A+, D, E, F, G	41.0046	98.00	117.60
1200 x 600mm	665	2269	300W	A, A+, D, E, F, G	41.0048	103.00	123.60
1200 x 750mm	796	2716	450W	A, A+, D, E, F, G	41.0094	130.00	156.00

### Wendover - Curved Gloss White 1600mm Height

Size H x W	Watts	BTU	Element Output	Element Type	Code	£ Ex VAT	£ Inc VAT
1600 x 400mm	637	2173	300W	A, A+, D, E, F, G	41.0050	112.00	134.40
1600 x 500mm	754	2573	450W	A, A+, D, E, F, G	41.0052	124.00	148.80
1600 x 600mm	870	2968	450W	A, A+, D, E, F, G	41.0054	131.00	157.20
1600 x 750mm	1041	3552	600W	A, A+, D, E, F, G	41.0095	158.00	189.60

### Wendover - Curved Gloss White 1800mm Height

Size H x W	Watts	BTU	Element Output	Element Type	Code	£ Ex VAT	£ Inc VAT
1800 x 400mm	728	2484	300W	A, A+, D, E, F, G	41.0056	125.00	150.00
1800 x 500mm	863	2945	450W	A, A+, D, E, F, G	41.0058	136.00	163.20
1800 x 600mm	998	3405	600W	A, A+, D, E, F, G	41.0060	146.00	175.20
1800 x 750mm	1193	4071	600W	A, A+, D, E, F, G	41.0096	178.00	213.60

### Radiator Valves

Page 301-309



### TECHNICAL INFORMATION

All measurements in Height by Width. Heat output based on  $\Delta T60^{\circ}\text{C}$ . Radiators that are electric only are restricted to the heat output of the elements. Element size can be increased to full capacity of rail if using element type D, E, F or G. (Type F & G Elements suitable for all electric only) For element types see pages 288-300. For matching valves see pages 301-309. For indirect heating systems only. Tappings are approx. 50mm less than the width of the rail and approx. 70mm off the wall. Price includes radiator and wall fixing sets, valves extra.

### Round Vent Caps

Page 313



### Robe Hooks

Page 310

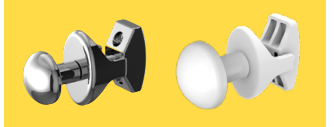

<b>Warranty</b> <b>5</b> Year	<b>Diameter (Ø)</b> <b>22</b> MM Bars	<b>Heating</b> 	<b>All Electric</b> 	<b>Dual-Fuel</b> 
-------------------------------------	---	--------------------	-------------------------	----------------------

# Multirail Range

## WENDOVER - STRAIGHT MATT ANTHRACITE



Pictured 41.0324 Matt Anthracite



Pictured 41.0326 Matt Anthracite

A modern ladder towel rail, available in a vast array of sizes including 600mm high by 1200mm wide, as pictured above, which is ideal for under-window situation. The Wendover range is available in chrome, brushed brass, gloss white and matt anthracite, along with matching radiator valves and pipe shrouds.

### NEW! Wendover - Straight Matt Anthracite 360mm Height

Size H x W	Watts	BTU	Element Output	Element Type	Code	£ Ex VAT	£ Inc VAT
360 x 400mm	159	543	150W	B, D, E, F, G	41.0630	50.00	60.00

### NEW! Wendover - Straight Matt Anthracite 600mm Height

Size H x W	Watts	BTU	Element Output	Element Type	Code	£ Ex VAT	£ Inc VAT
600 x 300mm	196	669	100W	A, A+, D, E, F, G	41.0631	58.00	69.60
600 x 400mm	241	822	150W	A, A+, D, E, F, G	41.0320	65.00	78.00
600 x 500mm	285	972	150W	A, A+, D, E, F, G	41.0321	69.00	82.80
600 x 600mm	330	1126	150W	A, A+, D, E, F, G	41.0322	73.00	87.60
600 x 750mm	397	1355	150W	A, A+, D, E, F, G	41.0632	83.00	99.60
600 x 1000mm	510	1740	300W	A, A+, D, E, F, G	41.0633	119.00	142.80
600 x 1200mm	600	2047	300W	A, A+, D, E, F, G	41.0634	130.00	156.00

Warranty

**5**

Year

Diameter (Ø)

**22**

MM Bars

Heating



All Electric



Dual-Fuel





# Multirail Range

## WENDOVER - STRAIGHT MATT ANTHRACITE

### NEW! Wendover - Straight Matt Anthracite 800mm Height

Size H x W	Watts	BTU	Element Output	Element Type	Code	£ Ex VAT	£ Inc VAT
800 x 300mm	267	911	150W	A, A+, D, E, F, G	41.0635	70.00	84.00
800 x 400mm	330	1126	150W	A, A+, D, E, F, G	41.0636	73.00	87.60
800 x 500mm	394	1344	150W	A, A+, D, E, F, G	41.0637	79.00	94.80
800 x 600mm	457	1559	150W	A, A+, D, E, F, G	41.0638	86.00	103.20
800 x 750mm	551	1880	300W	A, A+, D, E, F, G	41.0639	104.00	124.80

### NEW! Wendover - Straight Matt Anthracite 1400mm Height

Size H x W	Watts	BTU	Element Output	Element Type	Code	£ Ex VAT	£ Inc VAT
1400 x 300mm	444	1515	150W	A, A+, D, E, F, G	41.0647	98.00	117.60
1400 x 400mm	542	1849	300W	A, A+, D, E, F, G	41.0648	103.00	123.60
1400 x 500mm	642	2191	300W	A, A+, D, E, F, G	41.0649	114.00	136.80
1400 x 600mm	740	2425	300W	A, A+, D, E, F, G	41.0650	121.00	145.20
1400 x 750mm	888	3030	450W	A, A+, D, E, F, G	41.0651	151.00	181.20

### NEW! Wendover - Straight Matt Anthracite 1000mm Height

Size H x W	Watts	BTU	Element Output	Element Type	Code	£ Ex VAT	£ Inc VAT
1000 x 300mm	320	1092	150W	A, A+, D, E, F, G	41.0640	81.00	97.20
1000 x 400mm	392	1338	150W	A, A+, D, E, F, G	41.0641	83.00	99.60
1000 x 500mm	464	1583	150W	A, A+, D, E, F, G	41.0642	91.00	109.20
1000 x 600mm	535	1825	300W	A, A+, D, E, F, G	41.0643	95.00	114.00
1000 x 750mm	643	2194	300W	A, A+, D, E, F, G	41.0644	117.00	140.40

### NEW! Wendover - Straight Matt Anthracite 1600mm Height

Size H x W	Watts	BTU	Element Output	Element Type	Code	£ Ex VAT	£ Inc VAT
1600 x 300mm	516	1761	300W	A, A+, D, E, F, G	41.0652	108.00	129.60
1600 x 400mm	632	2156	300W	A, A+, D, E, F, G	41.0653	114.00	136.80
1600 x 500mm	749	2556	450W	A, A+, D, E, F, G	41.0654	125.00	150.00
1600 x 600mm	867	2958	450W	A, A+, D, E, F, G	41.0655	137.00	164.40
1600 x 750mm	1041	3552	600W	A, A+, D, E, F, G	41.0656	171.00	205.20

### NEW! Wendover - Straight Matt Anthracite 1200mm Height

Size H x W	Watts	BTU	Element Output	Element Type	Code	£ Ex VAT	£ Inc VAT
1200 x 300mm	392	1338	150W	A, A+, D, E, F, G	41.0645	92.00	110.40
1200 x 400mm	482	1645	300W	A, A+, D, E, F, G	41.0323	96.00	115.20
1200 x 500mm	571	1948	300W	A, A+, D, E, F, G	41.0324	100.00	120.00
1200 x 600mm	661	2255	300W	A, A+, D, E, F, G	41.0325	107.00	128.40
1200 x 750mm	796	2716	450W	A, A+, D, E, F, G	41.0646	138.00	165.60

### NEW! Wendover - Straight Matt Anthracite 1800mm Height

Size H x W	Watts	BTU	Element Output	Element Type	Code	£ Ex VAT	£ Inc VAT
1800 x 300mm	588	2006	300W	A, A+, D, E, F, G	41.0657	122.00	146.40
1800 x 400mm	723	2467	300W	A, A+, D, E, F, G	41.0658	130.00	156.00
1800 x 500mm	856	2921	450W	A, A+, D, E, F, G	41.0326	139.00	166.80
1800 x 600mm	991	3381	600W	A, A+, D, E, F, G	41.0327	150.00	180.00
1800 x 750mm	1193	4071	600W	A, A+, D, E, F, G	41.0659	191.00	229.20

**Round Vent Caps**  
Page 313

**Robe Hooks**  
Page 310

**Towel Hangers**  
Page 310

**Multi-Rail Hangers**  
Page 310

## TECHNICAL INFORMATION

All measurements in Height by Width. Heat output based on  $\Delta T60^{\circ}\text{C}$ . Radiators that are electric only are restricted to the heat output of the elements. Element size can be increased to full capacity of rail if using element type D, E, F or G. (Type F & G Elements suitable for all electric only) For element types see pages 288-300. For matching valves see pages 301-309. For indirect heating systems only. Tappings are approx. 50mm less than the width of the rail and approx. 75-95mm off the wall. Projection from wall 90-110mm. Price includes radiator and wall fixing sets, valves extra.

**Technical Tables & Drawings**  
Page 316-317

800mm High  
**NEW**

1000mm High  
**NEW**

1200mm High  
**NEW**

1400mm High  
**NEW**

1600mm High  
**NEW**

1800mm High  
**NEW**

# Multirail Range

## WENDOVER - STRAIGHT MATT BLACK



Pictured 41.0670 Matt Black



Pictured 41.0681 Matt Black

A modern ladder towel rail, available in a vast array of sizes including 600mm high by 1200mm wide, as pictured above, which is ideal for under-window situation. The Wendover range is available in chrome, brushed brass, gloss white and matt anthracite, along with matching radiator valves and pipe shrouds.

### NEW! Wendover - Straight Matt Black 360mm Height

Size H x W	Watts	BTU	Element Output	Element Type	Code	£ Ex VAT	£ Inc VAT
360 x 400mm	159	543	150W	B, D, E, F, G	41.0660	50.00	<b>60.00</b>

### NEW! Wendover - Straight Matt Black 600mm Height

Size H x W	Watts	BTU	Element Output	Element Type	Code	£ Ex VAT	£ Inc VAT
600 x 300mm	196	669	100W	A, A+, D, E, F, G	41.0661	58.00	<b>69.60</b>
600 x 400mm	241	822	150W	A, A+, D, E, F, G	41.0662	65.00	<b>78.00</b>
600 x 500mm	285	972	150W	A, A+, D, E, F, G	41.0663	69.00	<b>82.80</b>
600 x 600mm	330	1126	150W	A, A+, D, E, F, G	41.0664	73.00	<b>87.60</b>
600 x 750mm	397	1355	150W	A, A+, D, E, F, G	41.0665	83.00	<b>99.60</b>
600 x 1000mm	510	1740	300W	A, A+, D, E, F, G	41.0666	119.00	<b>142.80</b>
600 x 1200mm	600	2047	300W	A, A+, D, E, F, G	41.0667	130.00	<b>156.00</b>

Warranty

**5**

Year

Diameter (Ø)

**22**

MM Bars

Heating

All Electric

Dual-Fuel

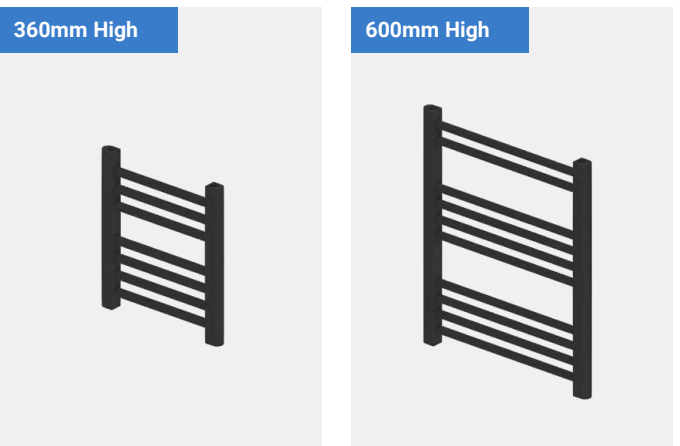



# Multirail Range

## WENDOVER - STRAIGHT MATT BLACK

### NEW! Wendover - Straight Matt Black 800mm Height

Size H x W	Watts	BTU	Element Output	Element Type	Code	£ Ex VAT	£ Inc VAT
800 x 300mm	267	911	150W	A, A+, D, E, F, G	41.0668	70.00	<b>84.00</b>
800 x 400mm	330	1126	150W	A, A+, D, E, F, G	41.0669	73.00	<b>87.60</b>
800 x 500mm	394	1344	150W	A, A+, D, E, F, G	41.0670	79.00	<b>94.80</b>
800 x 600mm	457	1559	150W	A, A+, D, E, F, G	41.0671	86.00	<b>103.20</b>
800 x 750mm	551	1880	300W	A, A+, D, E, F, G	41.0672	104.00	<b>124.80</b>

### NEW! Wendover - Straight Matt Black 1000mm Height

Size H x W	Watts	BTU	Element Output	Element Type	Code	£ Ex VAT	£ Inc VAT
1000 x 300mm	320	1092	150W	A, A+, D, E, F, G	41.0673	81.00	<b>97.20</b>
1000 x 400mm	392	1338	150W	A, A+, D, E, F, G	41.0674	83.00	<b>99.60</b>
1000 x 500mm	464	1583	150W	A, A+, D, E, F, G	41.0675	91.00	<b>109.20</b>
1000 x 600mm	535	1825	300W	A, A+, D, E, F, G	41.0676	95.00	<b>114.00</b>
1000 x 750mm	643	2194	300W	A, A+, D, E, F, G	41.0677	117.00	<b>140.40</b>

### NEW! Wendover - Straight Matt Black 1200mm Height

Size H x W	Watts	BTU	Element Output	Element Type	Code	£ Ex VAT	£ Inc VAT
1200 x 300mm	392	1338	150W	A, A+, D, E, F, G	41.0678	92.00	<b>110.40</b>
1200 x 400mm	482	1645	300W	A, A+, D, E, F, G	41.0679	96.00	<b>115.20</b>
1200 x 500mm	571	1948	300W	A, A+, D, E, F, G	41.0680	100.00	<b>120.00</b>
1200 x 600mm	661	2255	300W	A, A+, D, E, F, G	41.0681	107.00	<b>128.40</b>
1200 x 750mm	796	2716	450W	A, A+, D, E, F, G	41.0682	138.00	<b>165.60</b>

### NEW! Wendover - Straight Matt Black 1400mm Height

Size H x W	Watts	BTU	Element Output	Element Type	Code	£ Ex VAT	£ Inc VAT
1400 x 300mm	444	1515	150W	A, A+, D, E, F, G	41.0683	98.00	<b>117.60</b>
1400 x 400mm	542	1849	300W	A, A+, D, E, F, G	41.0684	103.00	<b>123.60</b>
1400 x 500mm	642	2191	300W	A, A+, D, E, F, G	41.0685	114.00	<b>136.80</b>
1400 x 600mm	740	2425	300W	A, A+, D, E, F, G	41.0686	121.00	<b>145.20</b>
1400 x 750mm	888	3030	450W	A, A+, D, E, F, G	41.0687	151.00	<b>181.20</b>

### NEW! Wendover - Straight Matt Black 1600mm Height

Size H x W	Watts	BTU	Element Output	Element Type	Code	£ Ex VAT	£ Inc VAT
1600 x 300mm	516	1761	300W	A, A+, D, E, F, G	41.0688	108.00	<b>129.60</b>
1600 x 400mm	632	2156	300W	A, A+, D, E, F, G	41.0689	114.00	<b>136.80</b>
1600 x 500mm	749	2556	450W	A, A+, D, E, F, G	41.0690	125.00	<b>150.00</b>
1600 x 600mm	867	2958	450W	A, A+, D, E, F, G	41.0691	137.00	<b>164.40</b>
1600 x 750mm	1041	3552	600W	A, A+, D, E, F, G	41.0692	171.00	<b>205.20</b>

### NEW! Wendover - Straight Matt Black 1800mm Height

Size H x W	Watts	BTU	Element Output	Element Type	Code	£ Ex VAT	£ Inc VAT
1800 x 300mm	588	2006	300W	A, A+, D, E, F, G	41.0693	122.00	<b>146.40</b>
1800 x 400mm	723	2467	300W	A, A+, D, E, F, G	41.0694	130.00	<b>156.00</b>
1800 x 500mm	856	2921	450W	A, A+, D, E, F, G	41.0695	139.00	<b>166.80</b>
1800 x 600mm	991	3381	600W	A, A+, D, E, F, G	41.0696	150.00	<b>180.00</b>
1800 x 750mm	1193	4071	600W	A, A+, D, E, F, G	41.0697	191.00	<b>229.20</b>

#### Round Vent Caps

Page 313



#### Robe Hooks

Page 310

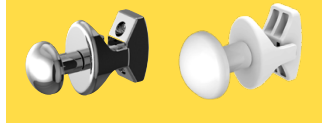

#### Towel Hangers

Page 310



#### Multi-Rail Hangers

Page 310



### TECHNICAL INFORMATION

All measurements in Height by Width. Heat output based on  $\Delta T60^{\circ}\text{C}$ . Radiators that are electric only are restricted to the heat output of the elements. Element size can be increased to full capacity of rail if using element type D, E, F or G. (Type F & G Elements suitable for all electric only) For element types see pages 288-300. For matching valves see pages 301-309. For indirect heating systems only. Tappings are approx. 50mm less than the width of the rail and approx. 75-95mm off the wall. Projection from wall 90-110mm. Price includes radiator and wall fixing sets, valves extra.

#### Technical Tables & Drawings

Page 316-317



#### 800mm High

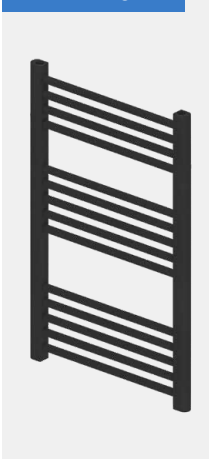

#### 1000mm High

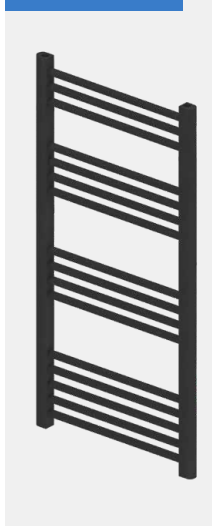

#### 1200mm High

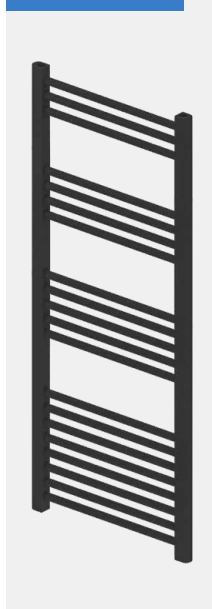

#### 1400mm High

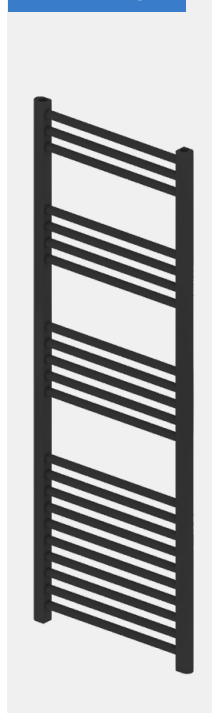

#### 1600mm High

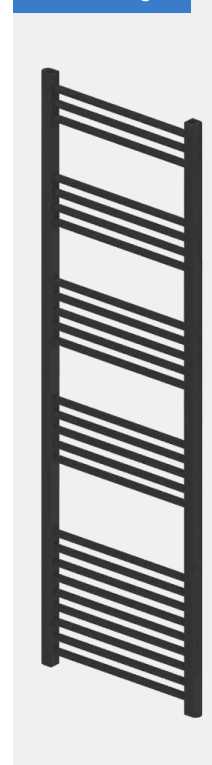

#### 1800mm High

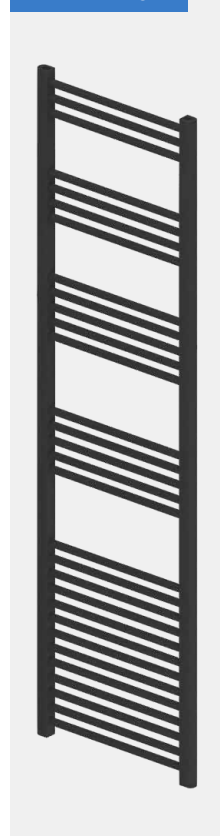

# Multirail Range

## WENDOVER - STRAIGHT BRUSHED BRASS



A modern ladder towel rail, available in a vast array of sizes including 1200mm high by 500mm wide, as pictured above, which is ideal for bathrooms. The Wendover range is available in chrome, brushed brass, gloss white and matt anthracite, along with matching radiator valves and pipe shrouds.

### NEW! Wendover - Straight Brushed Brass 600mm Height

Size H x W	Watts	BTU	Element Output	Element Type	Code	£ Ex VAT	£ Inc VAT
600 x 400mm	190	648	100W	A, A+, D, E, F, G	41.0698	219.00	262.80
600 x 500mm	225	768	100W	A, A+, D, E, F, G	41.0699	229.00	274.80
600 x 600mm	260	887	150W	A, A+, D, E, F, G	41.0700	239.00	286.80

### FEATURES

- 22mm diameter horizontal round tubes
  - Rear fixing wall brackets
  - Tested to BS EN 442 standards
  - 5 Year manufacturer's warranty\*
  - Can be single or dual fuel, or all electric
- \* With conditions

Warranty

5

Year

Diameter (Ø)

22

MM Bars

Heating

All Electric

Dual-Fuel

Pictured 41.0732

NEW

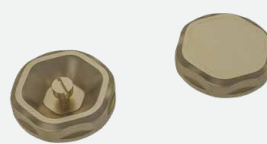

### Bleed Valve & Blanking Plug Set - Brushed Brass

Code	£ Ex VAT	£ Inc VAT
41.0732	11.00	13.20

600mm High

NEW



Technical Tables & Drawings  
Page 316-317



# Multirail Range

## WENDOVER - STRAIGHT BRUSHED BRASS

### NEW! Wendover - Straight Brushed Brass 800mm Height

Size H x W	Watts	BTU	Element Output	Element Type	Code	£ Ex VAT	£ Inc VAT
800 x 400mm	260	887	150W	A, A+, D, E, F, G	41.0701	266.00	<b>319.20</b>
800 x 500mm	309	1054	150W	A, A+, D, E, F, G	41.0361	283.00	<b>339.60</b>
800 x 600mm	359	1225	150W	A, A+, D, E, F, G	41.0362	296.00	<b>355.20</b>

### NEW! Wendover - Straight Brushed Brass 1000mm Height

Size H x W	Watts	BTU	Element Output	Element Type	Code	£ Ex VAT	£ Inc VAT
1000 x 400mm	308	1051	150W	A, A+, D, E, F, G	41.0702	325.00	<b>390.00</b>
1000 x 500mm	364	1242	150W	A, A+, D, E, F, G	41.0703	339.00	<b>406.80</b>
1000 x 600mm	421	1436	150W	A, A+, D, E, F, G	41.0704	353.00	<b>423.60</b>

### NEW! Wendover - Straight Brushed Brass 1200mm Height

Size H x W	Watts	BTU	Element Output	Element Type	Code	£ Ex VAT	£ Inc VAT
1200 x 400mm	379	1293	150W	A, A+, D, E, F, G	41.0705	386.00	<b>463.20</b>
1200 x 500mm	450	1535	150W	A, A+, D, E, F, G	41.0363	405.00	<b>486.00</b>
1200 x 600mm	554	1890	300W	A, A+, D, E, F, G	41.0364	424.00	<b>508.80</b>

### NEW! Wendover - Straight Brushed Brass 1400mm Height

Size H x W	Watts	BTU	Element Output	Element Type	Code	£ Ex VAT	£ Inc VAT
1400 x 400mm	429	1464	150W	A, A+, D, E, F, G	41.0706	448.00	<b>537.60</b>
1400 x 500mm	504	1720	150W	A, A+, D, E, F, G	41.0365	461.00	<b>553.20</b>
1400 x 600mm	582	1986	300W	A, A+, D, E, F, G	41.0366	483.00	<b>579.60</b>

### NEW! Wendover - Straight Brushed Brass 1600mm Height

Size H x W	Watts	BTU	Element Output	Element Type	Code	£ Ex VAT	£ Inc VAT
1600 x 400mm	497	1696	300W	A, A+, D, E, F, G	41.0707	509.00	<b>610.80</b>
1600 x 500mm	589	2010	300W	A, A+, D, E, F, G	41.0367	527.00	<b>632.40</b>
1600 x 600mm	681	2324	300W	A, A+, D, E, F, G	41.0368	552.00	<b>662.40</b>

### NEW! Wendover - Straight Brushed Brass 1800mm Height

Size H x W	Watts	BTU	Element Output	Element Type	Code	£ Ex VAT	£ Inc VAT
1800 x 400mm	568	1938	300W	A, A+, D, E, F, G	41.0708	576.00	<b>691.20</b>
1800 x 500mm	675	2303	300W	A, A+, D, E, F, G	41.0369	592.00	<b>710.40</b>
1800 x 600mm	780	2661	450W	A, A+, D, E, F, G	41.0370	621.00	<b>745.20</b>

**Round Vent Caps**  
Page 313

**Robe Hooks**  
Page 310

**Towel Hangers**  
Page 310

**Multi-Rail Hangers**  
Page 310



### TECHNICAL INFORMATION

All measurements in Height by Width. Heat output based on  $\Delta T60^{\circ}C$ . Radiators that are electric only are restricted to the heat output of the elements. Element size can be increased to full capacity of rail if using element type D, E, F or G. (Type F & G Elements suitable for all electric only) For element types see pages 288-300. For matching valves see pages 301-309. For indirect heating systems only. Tappings are approx. 50mm less than the width of the rail and approx. 59-69mm off the wall. Projection from wall 74-84mm. Price includes radiator and wall fixing sets, valves extra.



# Multirail Range

## BIAVA MULTIRAIL HIDDEN VENT (HV), STRAIGHT

Pictured 61.0082 Chrome



Pictured 61.0088 Gloss White

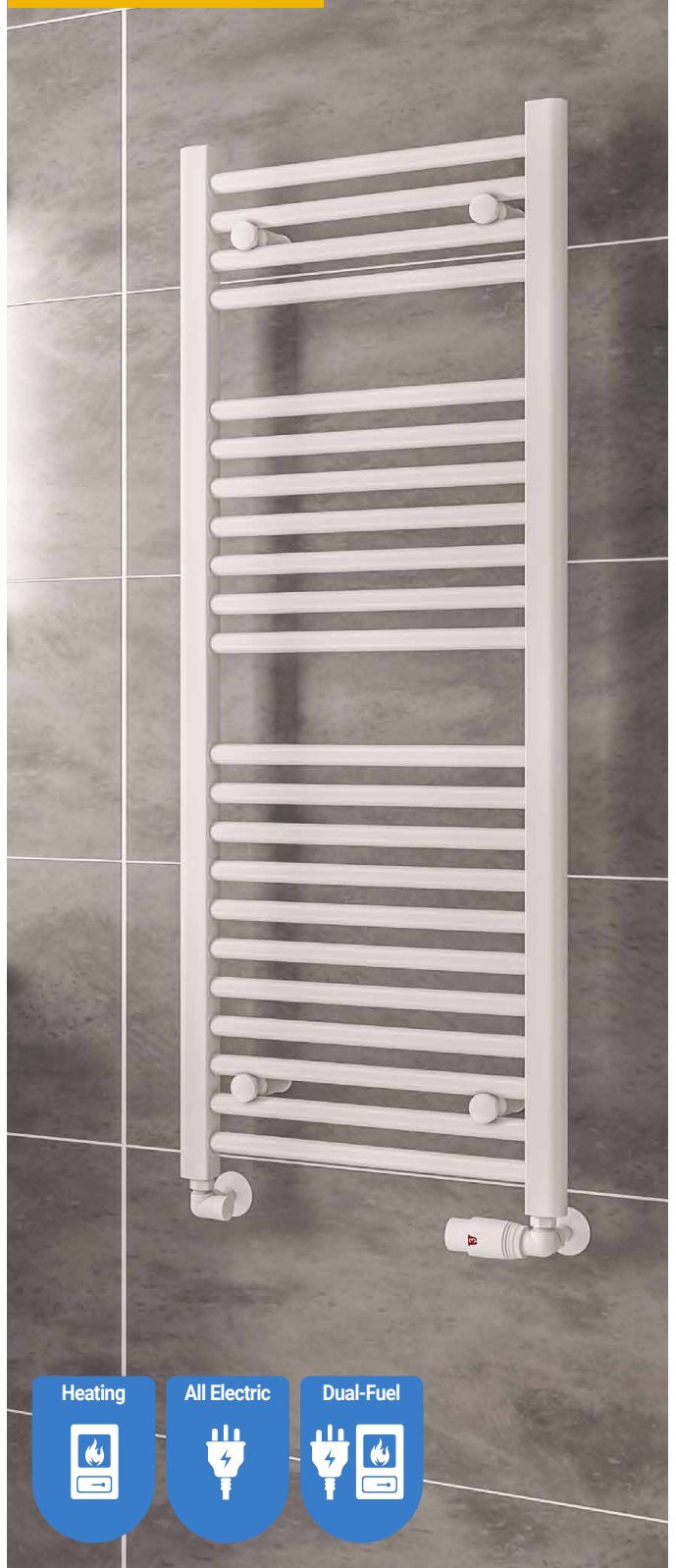

Warranty  
**5**  
Year

Diameter (Ø)  
**22**  
MM Bars

Technical Tables  
& Drawings  
Page 320-321



Biava Multirail HV towel rail rewrites the standards with the air vent hidden at the back of the towel rail and flush finished tops.

### FEATURES

- Tested to BS EN 442 standards
- Hidden air vent at the rear
- Tappings only at the bottom
- Flush finished tops
- Can be single, dual fuel or all electric
- 5 Year Manufacturer's Warranty\*
- \* With conditions

# Multirail Range

## BIAVA MULTIRAIL HIDDEN VENT (HV), STRAIGHT

Sleek, Minimalistic Tops



Pictured 61.0079 Chrome



Rear Side Hidden Air Vent



### Biava Multirail Hidden Vent (HV) Straight - Chrome

Size H x W	Watts	BTU	Element Output	Element Type	Code	£ Ex VAT	£ Inc VAT
360 x 400mm	113	386	N/A	N/A	61.0074	57.00	68.40
688 x 450mm	270	921	150W	A, A+, D, E, F, G	61.0075	86.00	103.20
688 x 600mm	344	1174	150W	A, A+, D, E, F, G	61.0076	97.00	116.40
688 x 750mm	418	1426	150W	A, A+, D, E, F, G	61.0077	109.00	130.80
1118 x 450mm	430	1467	150W	A, A+, D, E, F, G	61.0078	125.00	150.00
1118 x 600mm	546	1863	300W	A, A+, D, E, F, G	61.0079	142.00	170.40
1118 x 750mm	663	2262	300W	A, A+, D, E, F, G	61.0080	155.00	186.00
1720 x 450mm	663	2262	300W	A, A+, D, E, F, G	61.0081	167.00	200.40
1720 x 600mm	843	2876	450W	A, A+, D, E, F, G	61.0082	196.00	235.20
1720 x 750mm	1024	3494	600W	A, A+, D, E, F, G	61.0083	224.00	268.80

### Biava Multirail Hidden Vent (HV) Straight - Gloss White

Size H x W	Watts	BTU	Element Output	Element Type	Code	£ Ex VAT	£ Inc VAT
360 x 400mm	145	495	100W	A, A+, D, E, F, G	61.0084	49.00	58.80
688 x 450mm	344	1174	150W	A, A+, D, E, F, G	61.0085	67.00	80.40
688 x 600mm	438	1494	150W	A, A+, D, E, F, G	61.0086	73.00	87.60
688 x 750mm	532	1815	300W	A, A+, D, E, F, G	61.0087	79.00	94.80
1118 x 450mm	546	1863	300W	A, A+, D, E, F, G	61.0088	87.00	104.40
1118 x 600mm	695	2371	300W	A, A+, D, E, F, G	61.0089	97.00	116.40
1118 x 750mm	843	2876	450W	A, A+, D, E, F, G	61.0090	108.00	129.60
1720 x 450mm	843	2876	450W	A, A+, D, E, F, G	61.0091	117.00	140.40
1720 x 600mm	1072	3658	600W	A, A+, D, E, F, G	61.0092	133.00	159.60
1720 x 750mm	1302	4442	750W	A, A+, D, E, F, G	61.0093	149.00	178.80

Multi-Rail Hangers  
Page 310



Towel Hangers  
Page 310



Robe Hooks  
Page 310

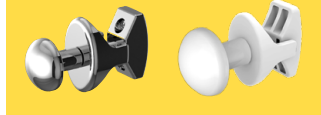

Room Divider Bracket Sets  
Page 311

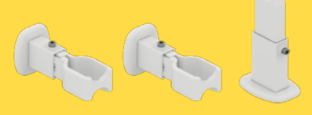

### Biava Multirail Hidden Vent (HV) Straight - Matt White

Size H x W	Watts	BTU	Element Output	Element Type	Code	£ Ex VAT	£ Inc VAT
360 x 400mm	145	495	100W	A, A+, D, E, F, G	61.0114	49.00	58.80
688 x 450mm	344	1174	150W	A, A+, D, E, F, G	61.0115	67.00	80.40
688 x 600mm	438	1494	150W	A, A+, D, E, F, G	61.0116	73.00	87.60
688 x 750mm	532	1815	300W	A, A+, D, E, F, G	61.0117	79.00	94.80
1118 x 450mm	546	1863	300W	A, A+, D, E, F, G	61.0118	87.00	104.40
1118 x 600mm	695	2371	300W	A, A+, D, E, F, G	61.0119	97.00	116.40
1118 x 750mm	843	2876	450W	A, A+, D, E, F, G	61.0120	108.00	129.60
1720 x 450mm	843	2876	450W	A, A+, D, E, F, G	61.0121	117.00	140.40
1720 x 600mm	1072	3658	600W	A, A+, D, E, F, G	61.0122	133.00	159.60
1720 x 750mm	1302	4442	750W	A, A+, D, E, F, G	61.0123	149.00	178.80

### TECHNICAL INFORMATION

All measurements in Height by Width. Heat output based on  $\Delta T60^{\circ}\text{C}$ . Radiators that are electric only are restricted to the heat output of the elements. Element size can be increased to full capacity of rail if using element type D, E, F or G. (Type F & G Elements suitable for all electric only) For element types see pages 288-300. For matching valves see pages 301-309. For indirect heating systems only. Tappings are approx. 50mm less than the width of the rail and approx. 70-85mm off the wall. Price includes radiator and wall fixing sets, valves extra.

360mm High



688mm High



1118mm High



1720mm High



# Multirail Range

## BIAVA MULTIRAIL HIDDEN VENT (HV), STRAIGHT, MATT ANTHRACITE



Technical Tables  
& Drawings  
Page 320-321



Pictured 61.0099 Matt Anthracite

### TECHNICAL INFORMATION

All measurements in Height by Width. Heat output based on  $\Delta T60^{\circ}\text{C}$ . Radiators that are electric only are restricted to the heat output of the elements. Element size can be increased to full capacity of rail if using element type D, E, F or G. (Type F & G Elements suitable for all electric only) For element types see pages 288-300. For matching valves see pages 301-309. For indirect heating systems only. Tappings are approx. 50mm less than the width of the rail and approx. 70-85mm off the wall. Price includes radiator and wall fixing sets, valves extra.

Sleek, Minimalistic Tops



Rear Side Hidden Air Vent



Pictured 61.0095 Matt Anthracite



Biava Multirail HV towel rail rewrites the standards with the air vent hidden at the back of the towel rail and flush finished tops.

### FEATURES

- Tested to BS EN 442 standards
- Hidden air vent at the rear
- Tappings only at the bottom
- Flush finished tops
- Can be single, dual fuel or all electric
- 5 Year Manufacturer's Warranty\*
- \* With conditions



Biava Multirail Hidden Vent (HV) Straight - Matt Anthracite							
Size H x W	Watts	BTU	Element Output	Element Type	Code	£ Ex VAT	£ Inc VAT
360 x 400mm	145	495	100W	A, A+, D, E, F, G	61.0094	49.00	58.80
688 x 450mm	344	1174	150W	A, A+, D, E, F, G	61.0095	67.00	80.40
688 x 600mm	438	1494	150W	A, A+, D, E, F, G	61.0096	73.00	87.60
688 x 750mm	532	1815	300W	A, A+, D, E, F, G	61.0097	79.00	94.80
1118 x 450mm	546	1863	300W	A, A+, D, E, F, G	61.0098	87.00	104.40
1118 x 600mm	695	2371	300W	A, A+, D, E, F, G	61.0099	97.00	116.40
1118 x 750mm	843	2876	450W	A, A+, D, E, F, G	61.0100	108.00	129.60
1720 x 450mm	843	2876	450W	A, A+, D, E, F, G	61.0101	117.00	140.40
1720 x 600mm	1072	3658	600W	A, A+, D, E, F, G	61.0102	133.00	159.60
1720 x 750mm	1302	4442	750W	A, A+, D, E, F, G	61.0103	149.00	178.80

# Multirail Range

## BIAVA MULTIRAIL HIDDEN VENT (HV), STRAIGHT, MATT BLACK

Sleek, Minimalistic Tops

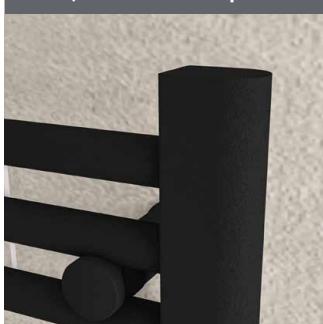

Rear Side Hidden Air Vent

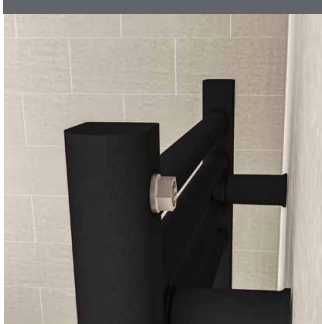

Heating

All Electric

Dual-Fuel

Pictured 61.0108 Matt Black



Biava Multirail HV towel rail rewrites the standards with the air vent hidden at the back of the towel rail and flush finished tops.

**FEATURES**

- Tested to BS EN 442 standards
- Hidden air vent at the rear
- Tappings only at the bottom
- Flush finished tops
- Can be single, dual fuel or all electric
- 5 Year Manufacturer's Warranty\*
- \* With conditions

Warranty

**5**

Year

Diameter (Ø)

**22**

MM Bars

Biava Multirail Hidden Vent (HV) Straight - Matt Black							
Size H x W	Watts	BTU	Element Output	Element Type	Code	£ Ex VAT	£ Inc VAT
360 x 400mm	145	495	100W	A, A+, D, E, F, G	61.0104	49.00	58.80
688 x 450mm	344	1174	150W	A, A+, D, E, F, G	61.0105	67.00	80.40
688 x 600mm	438	1494	150W	A, A+, D, E, F, G	61.0106	73.00	87.60
688 x 750mm	532	1815	300W	A, A+, D, E, F, G	61.0107	79.00	94.80
1118 x 450mm	546	1863	300W	A, A+, D, E, F, G	61.0108	87.00	104.40
1118 x 600mm	695	2371	300W	A, A+, D, E, F, G	61.0109	97.00	116.40
1118 x 750mm	843	2876	450W	A, A+, D, E, F, G	61.0110	108.00	129.60
1720 x 450mm	843	2876	450W	A, A+, D, E, F, G	61.0111	117.00	140.40
1720 x 600mm	1072	3658	600W	A, A+, D, E, F, G	61.0112	133.00	159.60
1720 x 750mm	1302	4442	750W	A, A+, D, E, F, G	61.0113	149.00	178.80



Pictured 61.0112 Matt Black

**TECHNICAL INFORMATION**

All measurements in Height by Width. Heat output based on ▲T60°C. Radiators that are electric only are restricted to the heat output of the elements. Element size can be increased to full capacity of rail if using element type D, E, F or G. (Type F & G Elements suitable for all electric only) For element types see pages 288-300. For matching valves see pages 301-309. For indirect heating systems only. Tappings are approx. 50mm less than the width of the rail and approx. 70-85mm off the wall. Price includes radiator and wall fixing sets, valves extra.

# Multirail Range

## WINGRAVE - STRAIGHT, CHROME

Technical Tables  
& Drawings  
Page 318-319

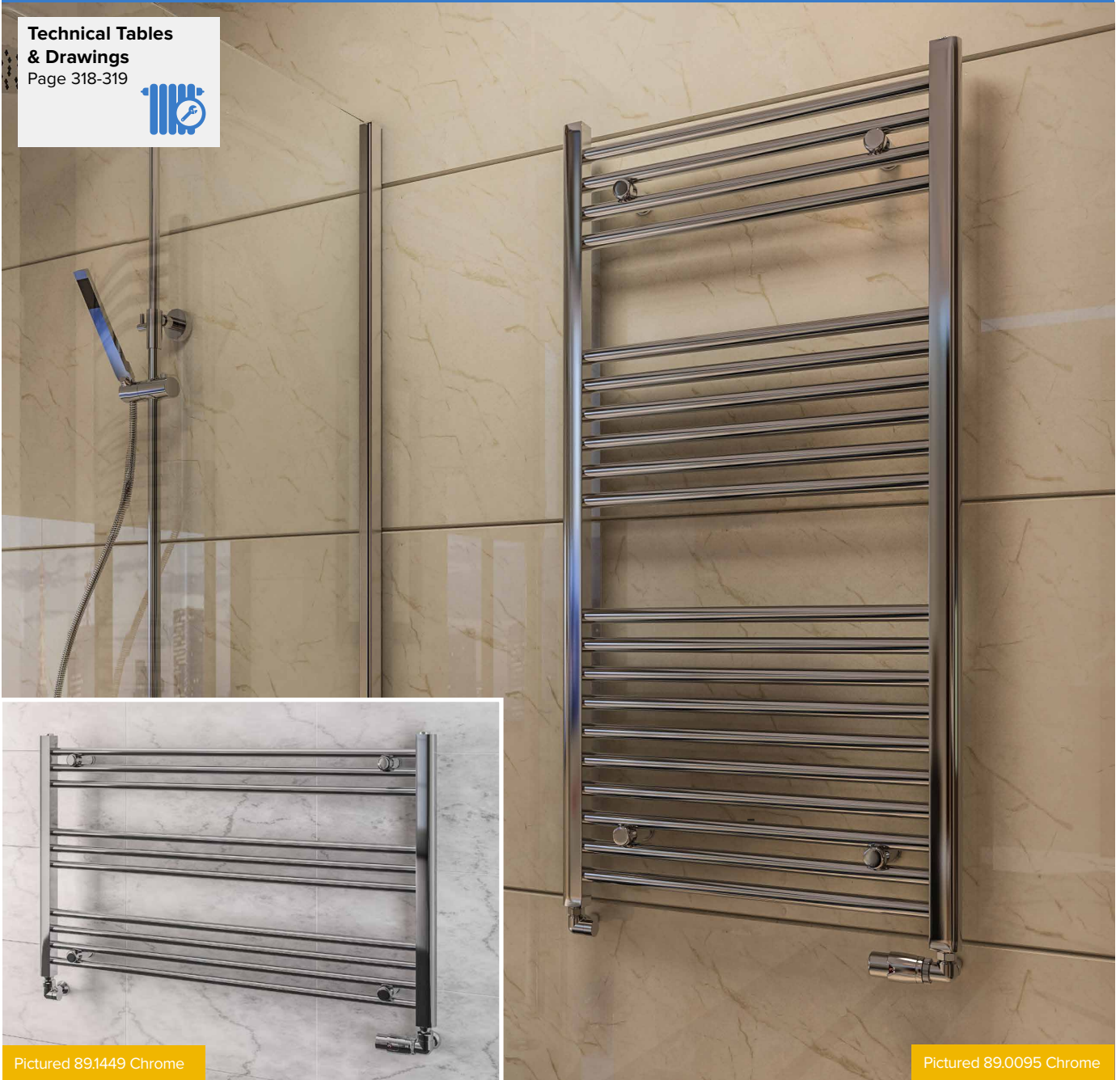

Pictured 89.1449 Chrome

Pictured 89.0095 Chrome

A contemporary straight towel radiator range which comes in chrome, matt anthracite, matt cobalt blue, matt black, matt grey, gloss white and matt white finishes. With a wide variety of sizes, this range not only adds to your bathroom with design simplicity but also keeps your towels warm.

### FEATURES

- 22mm diameter horizontal round tubes
- Wide range of sizes to fit in all spaces
- Horizontal sizes to fit under windows
- Tested to BS EN 442 standards
- 5 Year manufacturer's warranty\*
- Can be single or dual fuel, or all electric

\*With conditions

<p>Warranty</p> <p><b>5</b></p> <p>Year</p>	<p>Diameter (Ø)</p> <p><b>22</b></p> <p>MM Bars</p>	<p>Heating</p>	<p>All Electric</p>	<p>Dual-Fuel</p>
---	---	----------------	---------------------	------------------

600mm High

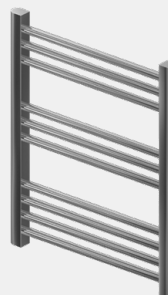

800mm High

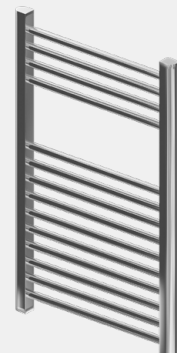



# Multirail Range

## WINGRAVE - STRAIGHT, CHROME

### Wingrave - Straight Chrome 600mm Height

Size H x W	Watts	BTU	Element Output	Element Type	Code	£ Ex VAT	£ Inc VAT
600 x 300mm	131	447	150W	D, E, F, G	89.0686	90.00	108.00
600 x 400mm	167	570	150W	D, E, F, G	89.0687	96.00	115.20
600 x 500mm	200	683	100W	A, A+, D, E, F, G	89.0688	107.00	128.40
600 x 600mm	233	795	150W	A, A+, D, E, F, G	89.0689	118.00	141.60
600 x 1000mm	355	1212	150W	A, A+, D, E, F, G	89.1449	191.00	229.20
600 x 1200mm	413	1410	150W	A, A+, D, E, F, G	89.1450	210.00	252.00

### Wingrave - Straight Chrome 800mm Height

Size H x W	Watts	BTU	Element Output	Element Type	Code	£ Ex VAT	£ Inc VAT
800 x 300mm	171	584	150W	D, E, F, G	89.0690	96.00	115.20
800 x 400mm	217	741	150W	A, A+, D, E, F, G	89.0083	101.00	121.20
800 x 500mm	261	891	150W	A, A+, D, E, F, G	89.0088	116.00	139.20
800 x 600mm	303	1034	150W	A, A+, D, E, F, G	89.0093	126.00	151.20

### Wingrave - Straight Chrome 1000mm Height

Size H x W	Watts	BTU	Element Output	Element Type	Code	£ Ex VAT	£ Inc VAT
1000 x 300mm	212	724	150W	A, A+, D, E, F, G	89.0691	112.00	134.40
1000 x 400mm	269	918	150W	A, A+, D, E, F, G	89.0084	121.00	145.20
1000 x 500mm	324	1106	150W	A, A+, D, E, F, G	89.0089	135.00	162.00
1000 x 600mm	376	1283	150W	A, A+, D, E, F, G	89.0094	146.00	175.20

### Wingrave - Straight Chrome 1200mm Height

Size H x W	Watts	BTU	Element Output	Element Type	Code	£ Ex VAT	£ Inc VAT
1200 x 300mm	256	874	150W	A, A+, D, E, F, G	89.0692	131.00	157.20
1200 x 400mm	324	1106	150W	A, A+, D, E, F, G	89.0085	139.00	166.80
1200 x 500mm	390	1331	150W	A, A+, D, E, F, G	89.0090	156.00	187.20
1200 x 600mm	454	1550	300W	A, A+, D, E, F, G	89.0095	174.00	208.80

### Wingrave - Straight Chrome 1400mm Height

Size H x W	Watts	BTU	Element Output	Element Type	Code	£ Ex VAT	£ Inc VAT
1400 x 300mm	302	1031	150W	A, A+, D, E, F, G	89.0693	168.00	201.60
1400 x 400mm	383	1307	150W	A, A+, D, E, F, G	89.0530	178.00	213.60
1400 x 500mm	461	1573	150W	A, A+, D, E, F, G	89.0531	193.00	231.60
1400 x 600mm	536	1829	300W	A, A+, D, E, F, G	89.0532	208.00	249.60

### Wingrave - Straight Chrome 1600mm Height

Size H x W	Watts	BTU	Element Output	Element Type	Code	£ Ex VAT	£ Inc VAT
1600 x 300mm	352	1202	150W	A, A+, D, E, F, G	89.0694	174.00	208.80
1600 x 400mm	446	1522	150W	A, A+, D, E, F, G	89.0086	185.00	222.00
1600 x 500mm	537	1833	300W	A, A+, D, E, F, G	89.0091	203.00	243.60
1600 x 600mm	624	2130	300W	A, A+, D, E, F, G	89.0096	219.00	262.80

### Wingrave - Straight Chrome 1800mm Height

Size H x W	Watts	BTU	Element Output	Element Type	Code	£ Ex VAT	£ Inc VAT
1800 x 300mm	405	1382	150W	A, A+, D, E, F, G	89.0695	192.00	230.40
1800 x 400mm	514	1754	300W	A, A+, D, E, F, G	89.0087	205.00	246.00
1800 x 500mm	618	2109	300W	A, A+, D, E, F, G	89.0092	229.00	274.80
1800 x 600mm	719	2454	450W	A, A+, D, E, F, G	89.0097	246.00	295.20

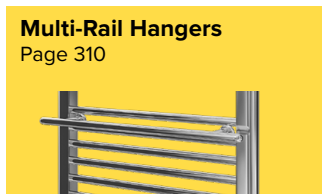
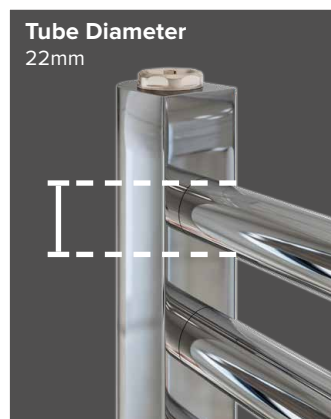

### TECHNICAL INFORMATION

All measurements in Height by Width. Heat output based on  $\Delta T60^{\circ}C$ . Radiators that are electric only are restricted to the heat output of the elements. Element size can be increased to full capacity of rail if using element type D, E, F or G. (Type F & G Elements suitable for all electric only) For element types see pages 288-300. For matching valves see pages 301-309. For indirect heating systems only. Tappings are approx. 44mm less than the width of the rail and approx. 65mm off the wall. Price includes radiator and wall fixing sets, valves extra.

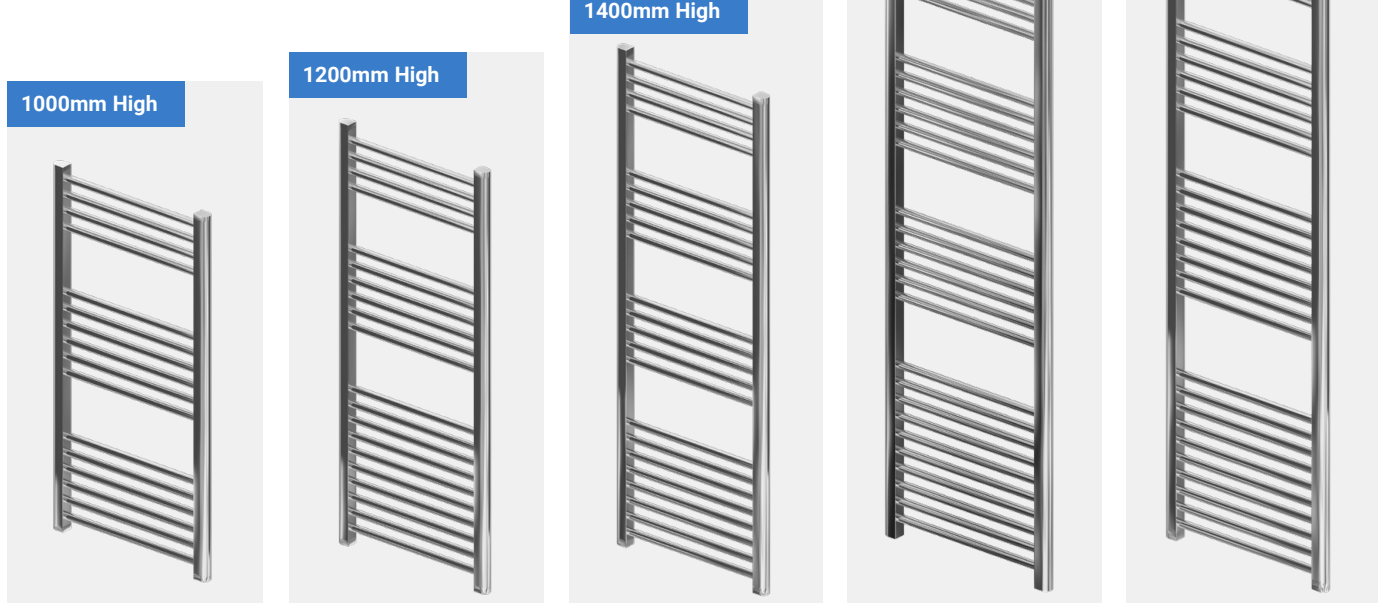

# Multirail Range

## WINGRAVE - STRAIGHT, GLOSS WHITE



Pictured 89.0127 Gloss White



Pictured 89.0122 Gloss White with 16.153 Room Divider Bracket Set

A contemporary straight towel radiator range which comes in chrome, matt anthracite, matt cobalt blue, matt black, matt grey, gloss white and matt white finishes. With a wide variety of sizes, this range not only adds to your bathroom with design simplicity but also keeps your towels warm.

### FEATURES

- 22mm diameter horizontal round tubes
  - Wide range of sizes to fit in all spaces
  - Horizontal sizes to fit under windows
  - Tested to BS EN 442 standards
  - 5 Year manufacturer's warranty\*
  - Can be single or dual fuel, or all electric
- \* With conditions

### Technical Tables & Drawings

Page 318-319



<b>Warranty</b> <b>5</b> Year	<b>Diameter (Ø)</b> <b>22</b> MM Bars	<b>Heating</b> 	<b>All Electric</b> 	<b>Dual-Fuel</b> 
-------------------------------------	---	--------------------	-------------------------	----------------------

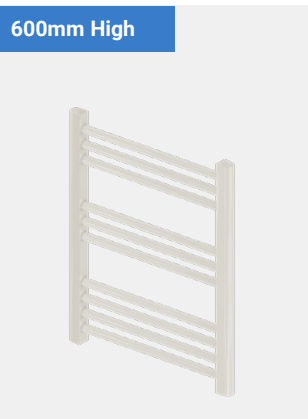

# Multirail Range

## WINGRAVE - STRAIGHT, GLOSS WHITE

Wingrave - Straight Gloss White 600mm Height							
Size H x W	Watts	BTU	Element Output	Element Type	Code	£ Ex VAT	£ Inc VAT
600 x 300mm	204	697	100W	A, A+, D, E, F, G	89.0646	60.00	72.00
600 x 400mm	257	877	150W	A, A+, D, E, F, G	89.0647	61.00	73.20
600 x 500mm	309	1055	150W	A, A+, D, E, F, G	89.0648	65.00	78.00
600 x 600mm	358	1222	150W	A, A+, D, E, F, G	89.0649	69.00	82.80
600 x 1000mm	543	1853	300W	A, A+, D, E, F, G	89.1439	125.00	150.00
600 x 1200mm	629	2147	300W	A, A+, D, E, F, G	89.1440	137.00	164.40

Wingrave - Straight Gloss White 800mm Height							
Size H x W	Watts	BTU	Element Output	Element Type	Code	£ Ex VAT	£ Inc VAT
800 x 300mm	266	908	150W	A, A+, D, E, F, G	89.0650	61.00	73.20
800 x 400mm	337	1150	150W	A, A+, D, E, F, G	89.0113	69.00	82.80
800 x 500mm	404	1379	150W	A, A+, D, E, F, G	89.0118	73.00	87.60
800 x 600mm	468	1597	300W	A, A+, D, E, F, G	89.0123	78.00	93.60

Wingrave - Straight Gloss White 1000mm Height							
Size H x W	Watts	BTU	Element Output	Element Type	Code	£ Ex VAT	£ Inc VAT
1000 x 300mm	331	1130	150W	A, A+, D, E, F, G	89.0651	69.00	82.80
1000 x 400mm	419	1430	150W	A, A+, D, E, F, G	89.0114	78.00	93.60
1000 x 500mm	502	1713	300W	A, A+, D, E, F, G	89.0119	84.00	100.80
1000 x 600mm	582	1986	300W	A, A+, D, E, F, G	89.0124	89.00	106.80

Wingrave - Straight Gloss White 1200mm Height							
Size H x W	Watts	BTU	Element Output	Element Type	Code	£ Ex VAT	£ Inc VAT
1200 x 300mm	398	1358	150W	A, A+, D, E, F, G	89.0652	79.00	94.80
1200 x 400mm	503	1717	300W	A, A+, D, E, F, G	89.0115	89.00	106.80
1200 x 500mm	604	2061	300W	A, A+, D, E, F, G	89.0120	92.00	110.40
1200 x 600mm	700	2389	300W	A, A+, D, E, F, G	89.0125	100.00	120.00

Wingrave - Straight Gloss White 1400mm Height							
Size H x W	Watts	BTU	Element Output	Element Type	Code	£ Ex VAT	£ Inc VAT
1400 x 300mm	468	1597	150W	A, A+, D, E, F, G	89.0653	96.00	115.20
1400 x 400mm	592	2020	300W	A, A+, D, E, F, G	89.0536	102.00	122.40
1400 x 500mm	710	2423	300W	A, A+, D, E, F, G	89.0537	110.00	132.00
1400 x 600mm	824	2812	450W	A, A+, D, E, F, G	89.0538	121.00	145.20

Wingrave - Straight Gloss White 1600mm Height							
Size H x W	Watts	BTU	Element Output	Element Type	Code	£ Ex VAT	£ Inc VAT
1600 x 300mm	542	1850	300W	A, A+, D, E, F, G	89.0654	97.00	116.40
1600 x 400mm	685	2338	300W	A, A+, D, E, F, G	89.0116	107.00	128.40
1600 x 500mm	821	2802	450W	A, A+, D, E, F, G	89.0121	118.00	141.60
1600 x 600mm	953	3252	450W	A, A+, D, E, F, G	89.0126	126.00	151.20

Wingrave - Straight Gloss White 1800mm Height							
Size H x W	Watts	BTU	Element Output	Element Type	Code	£ Ex VAT	£ Inc VAT
1800 x 300mm	619	2113	300W	A, A+, D, E, F, G	89.0655	107.00	128.40
1800 x 400mm	782	2669	450W	A, A+, D, E, F, G	89.0117	121.00	145.20
1800 x 500mm	938	3201	450W	A, A+, D, E, F, G	89.0122	137.00	164.40
1800 x 600mm	1088	3713	600W	A, A+, D, E, F, G	89.0127	138.00	165.60

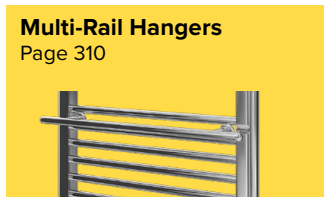
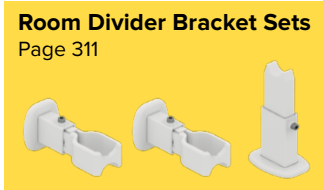
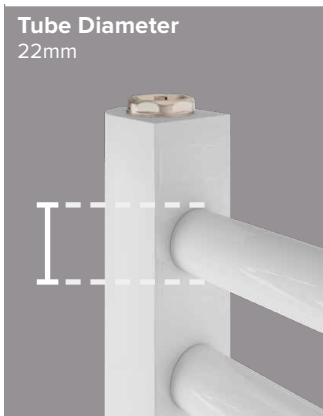

### TECHNICAL INFORMATION

All measurements in Height by Width. Heat output based on  $\Delta T60^{\circ}\text{C}$ . Radiators that are electric only are restricted to the heat output of the elements. Element size can be increased to full capacity of rail if using element type D, E, F or G. (Type F & G Elements suitable for all electric only) For element types see pages 288-300. For matching valves see pages 301-309. For indirect heating systems only. Tappings are approx. 44mm less than the width of the rail and approx. 65mm off the wall. Price includes radiator and wall fixing sets, valves extra.

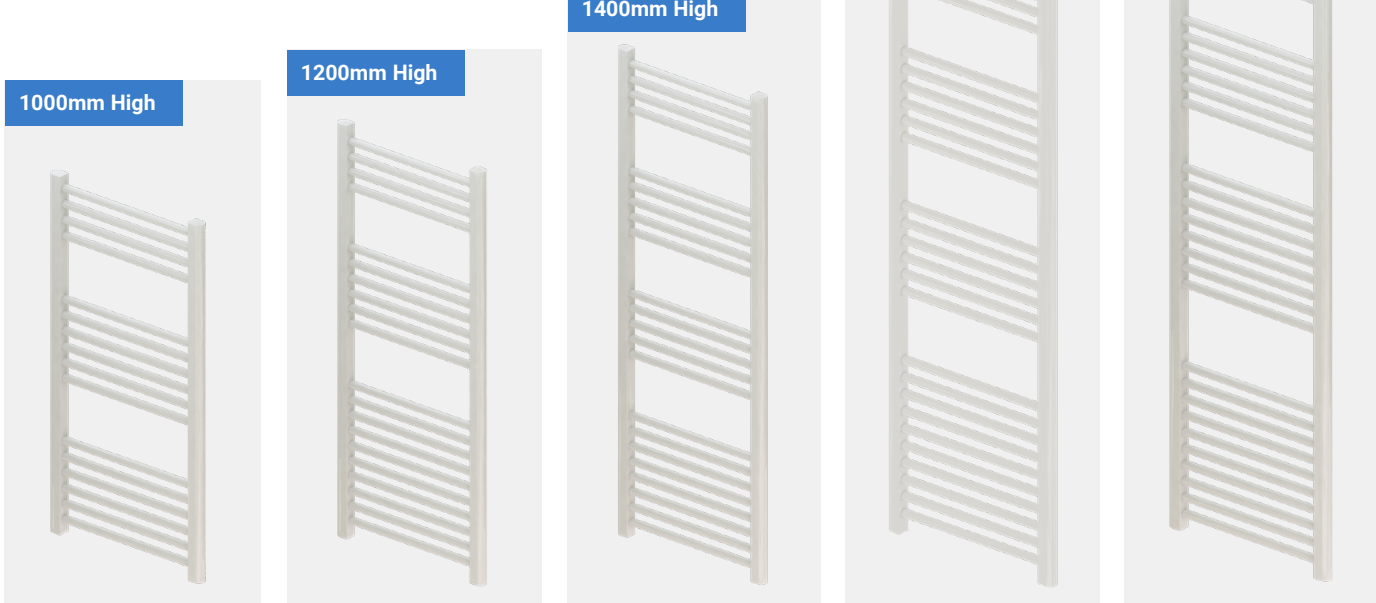

# Multirail Range

## WINGRAVE - STRAIGHT, MATT WHITE

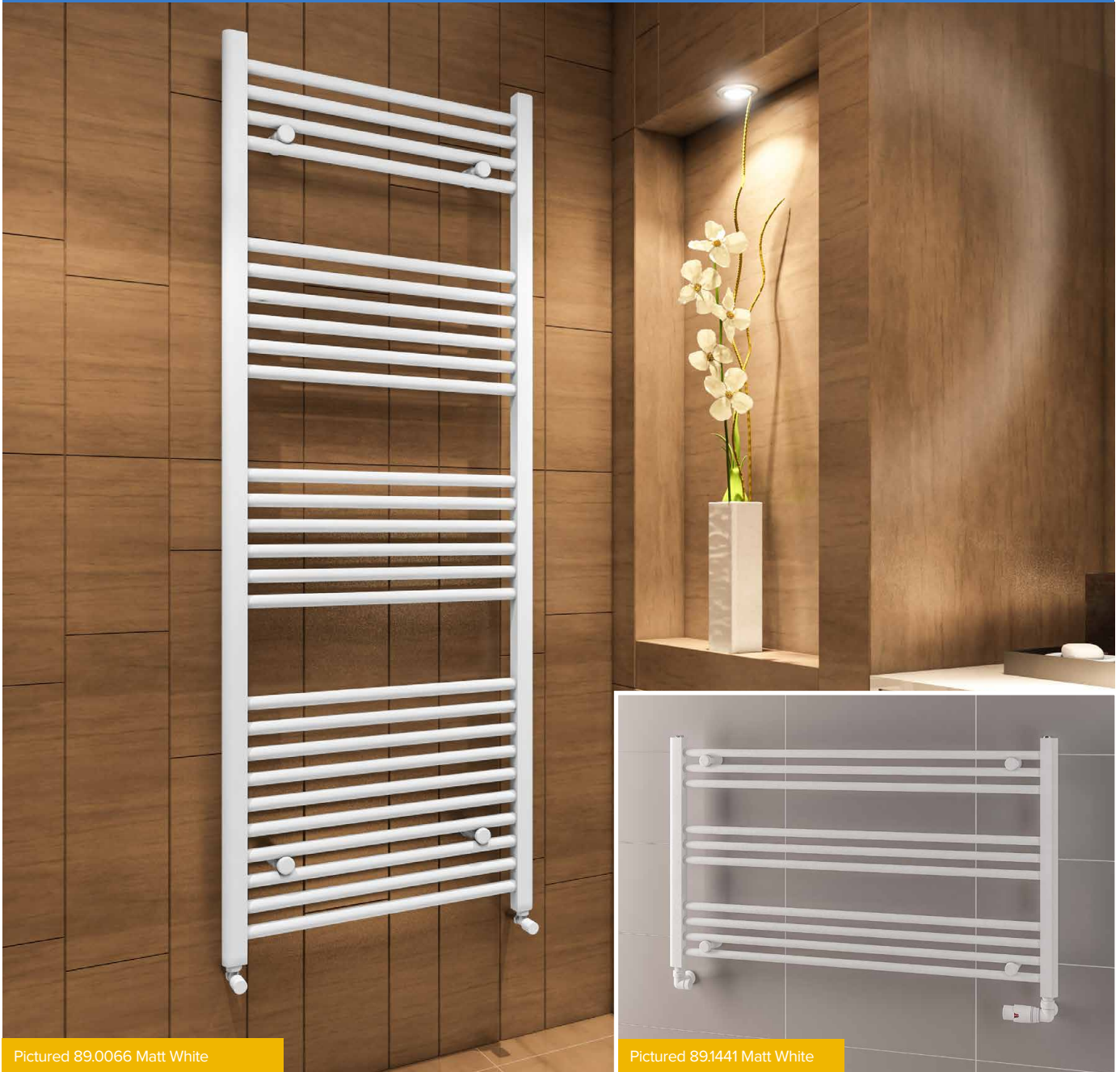

Pictured 89.0066 Matt White

Pictured 89.1441 Matt White

A contemporary straight towel radiator range which comes in chrome, matt anthracite, matt cobalt blue, matt black, matt grey, gloss white and matt white finishes. With a wide variety of sizes, this range not only adds to your bathroom with design simplicity but also keeps your towels warm.

**FEATURES**

- 22mm diameter horizontal round tubes
  - Wide range of sizes to fit in all spaces
  - Horizontal sizes to fit under windows
  - Tested to BS EN 442 standards
  - 5 Year manufacturer's warranty\*
  - Can be single or dual fuel, or all electric
- \* With conditions

**Technical Tables & Drawings**  
Page 318-319



<p>Warranty</p> <p><b>5</b></p> <p>Year</p>	<p>Diameter (Ø)</p> <p><b>22</b></p> <p>MM Bars</p>	<p>Heating</p>	<p>All Electric</p>	<p>Dual-Fuel</p>
---	---	----------------	---------------------	------------------

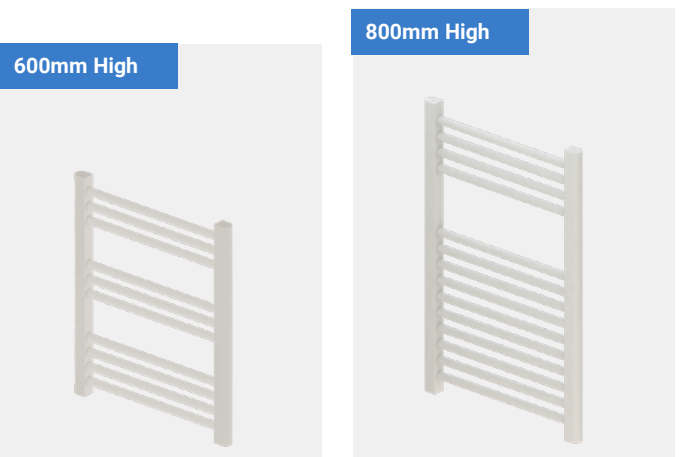

# Multirail Range

## WINGRAVE - STRAIGHT, MATT WHITE

### Wingrave - Straight Matt White 600mm Height

Size H x W	Watts	BTU	Element Output	Element Type	Code	£ Ex VAT	£ Inc VAT
600 x 300mm	204	697	100W	A, A+, D, E, F, G	89.0656	61.00	<b>73.20</b>
600 x 400mm	257	877	150W	A, A+, D, E, F, G	89.0657	63.00	<b>75.60</b>
600 x 500mm	309	1055	150W	A, A+, D, E, F, G	89.0658	69.00	<b>82.80</b>
600 x 600mm	358	1222	150W	A, A+, D, E, F, G	89.0659	72.00	<b>82.80</b>
600 x 1000mm	543	1853	300W	A, A+, D, F, G	89.1441	125.00	<b>150.00</b>
600 x 1200mm	629	2147	300W	A, A+, D, F, G	89.1442	137.00	<b>164.40</b>

### Wingrave - Straight Matt White 800mm Height

Size H x W	Watts	BTU	Element Output	Element Type	Code	£ Ex VAT	£ Inc VAT
800 x 300mm	266	908	150W	A, A+, D, E, F, G	89.0660	63.00	<b>75.60</b>
800 x 400mm	337	1150	150W	A, A+, D, E, F, G	89.0053	74.00	<b>88.80</b>
800 x 500mm	404	1379	150W	A, A+, D, E, F, G	89.0058	80.00	<b>96.00</b>
800 x 600mm	468	1597	300W	A, A+, D, E, F, G	89.0063	84.00	<b>100.80</b>

### Wingrave - Straight Matt White 1000mm Height

Size H x W	Watts	BTU	Element Output	Element Type	Code	£ Ex VAT	£ Inc VAT
1000 x 300mm	331	1130	150W	A, A+, D, E, F, G	89.0661	72.00	<b>86.40</b>
1000 x 400mm	419	1430	150W	A, A+, D, E, F, G	89.0054	84.00	<b>100.80</b>
1000 x 500mm	502	1713	300W	A, A+, D, E, F, G	89.0059	90.00	<b>108.00</b>
1000 x 600mm	582	1986	300W	A, A+, D, E, F, G	89.0064	97.00	<b>116.40</b>

### Wingrave - Straight Matt White 1200mm Height

Size H x W	Watts	BTU	Element Output	Element Type	Code	£ Ex VAT	£ Inc VAT
1200 x 300mm	398	1358	150W	A, A+, D, E, F, G	89.0662	83.00	<b>99.60</b>
1200 x 400mm	503	1717	300W	A, A+, D, E, F, G	89.0055	97.00	<b>116.40</b>
1200 x 500mm	604	2061	300W	A, A+, D, E, F, G	89.0060	101.00	<b>121.20</b>
1200 x 600mm	700	2389	300W	A, A+, D, E, F, G	89.0065	109.00	<b>130.80</b>

### Wingrave - Straight Matt White 1400mm Height

Size H x W	Watts	BTU	Element Output	Element Type	Code	£ Ex VAT	£ Inc VAT
1400 x 300mm	468	1597	150W	A, A+, D, E, F, G	89.0663	96.00	<b>115.20</b>
1400 x 400mm	592	2020	300W	A, A+, D, E, F, G	89.0539	109.00	<b>130.80</b>
1400 x 500mm	710	2423	300W	A, A+, D, E, F, G	89.0540	118.00	<b>141.60</b>
1400 x 600mm	824	2812	450W	A, A+, D, E, F, G	89.0541	126.00	<b>151.20</b>

### Wingrave - Straight Matt White 1600mm Height

Size H x W	Watts	BTU	Element Output	Element Type	Code	£ Ex VAT	£ Inc VAT
1600 x 300mm	542	1850	300W	A, A+, D, E, F, G	89.0664	100.00	<b>120.00</b>
1600 x 400mm	685	2338	300W	A, A+, D, E, F, G	89.0056	119.00	<b>142.80</b>
1600 x 500mm	821	2802	450W	A, A+, D, E, F, G	89.0061	128.00	<b>153.60</b>
1600 x 600mm	953	3252	450W	A, A+, D, E, F, G	89.0066	135.00	<b>162.00</b>

### Wingrave - Straight Matt White 1800mm Height

Size H x W	Watts	BTU	Element Output	Element Type	Code	£ Ex VAT	£ Inc VAT
1800 x 300mm	619	2113	300W	A, A+, D, E, F, G	89.0665	112.00	<b>134.40</b>
1800 x 400mm	782	2669	450W	A, A+, D, E, F, G	89.0057	130.00	<b>156.00</b>
1800 x 500mm	938	3201	450W	A, A+, D, E, F, G	89.0062	153.00	<b>183.60</b>
1800 x 600mm	1088	3713	600W	A, A+, D, E, F, G	89.0067	154.00	<b>184.80</b>

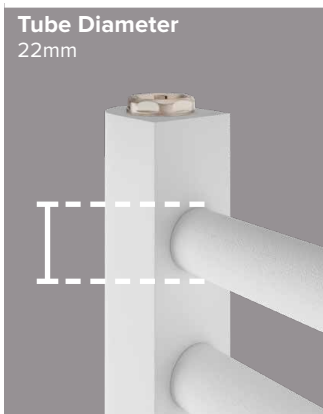

### Room Divider Bracket Sets

Page 311



### Vent Caps

Page 313



### Multi-Rail Hangers

Page 310



### Robe Hooks & Hangers

Page 310



### TECHNICAL INFORMATION

All measurements in Height by Width. Heat output based on  $\Delta T60^{\circ}\text{C}$ . Radiators that are electric only are restricted to the heat output of the elements. Element size can be increased to full capacity of rail if using element type D, E, F or G. (Type F & G Elements suitable for all electric only) For element types see pages 288-300. For matching valves see pages 301-309. For indirect heating systems only. Tappings are approx. 44mm less than the width of the rail and approx. 65mm off the wall. Price includes radiator and wall fixing sets, valves extra.

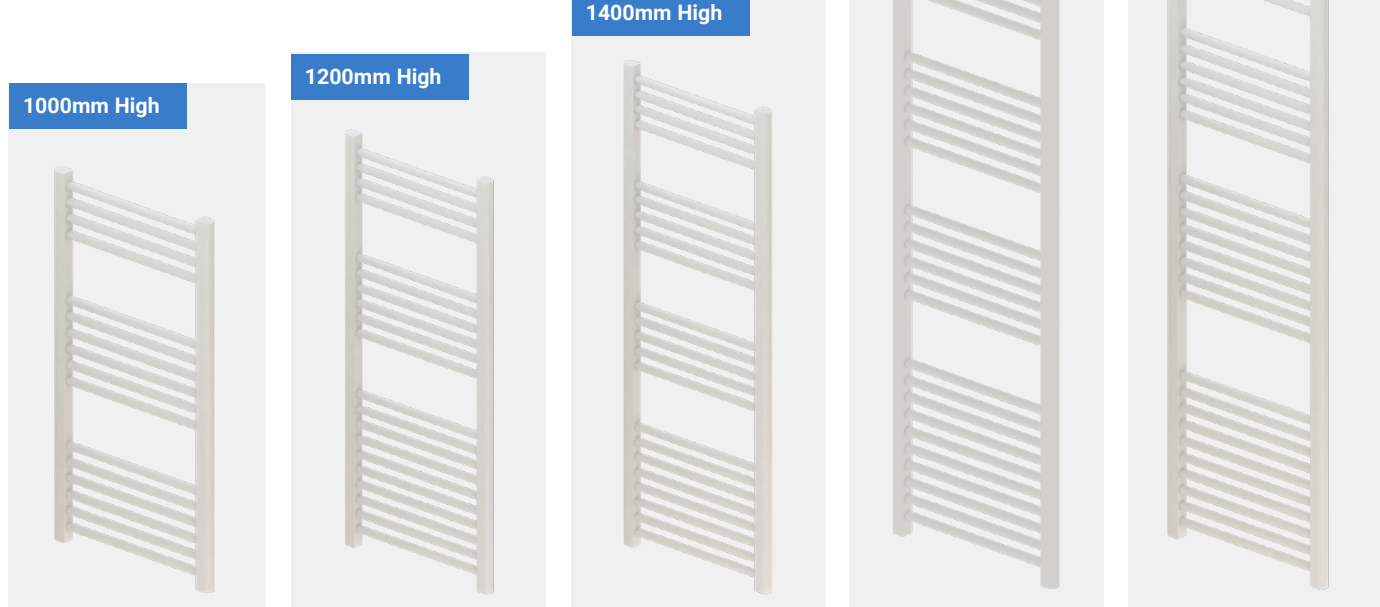

# Multirail Range

## WINGRAVE - STRAIGHT, MATT ANTHRACITE

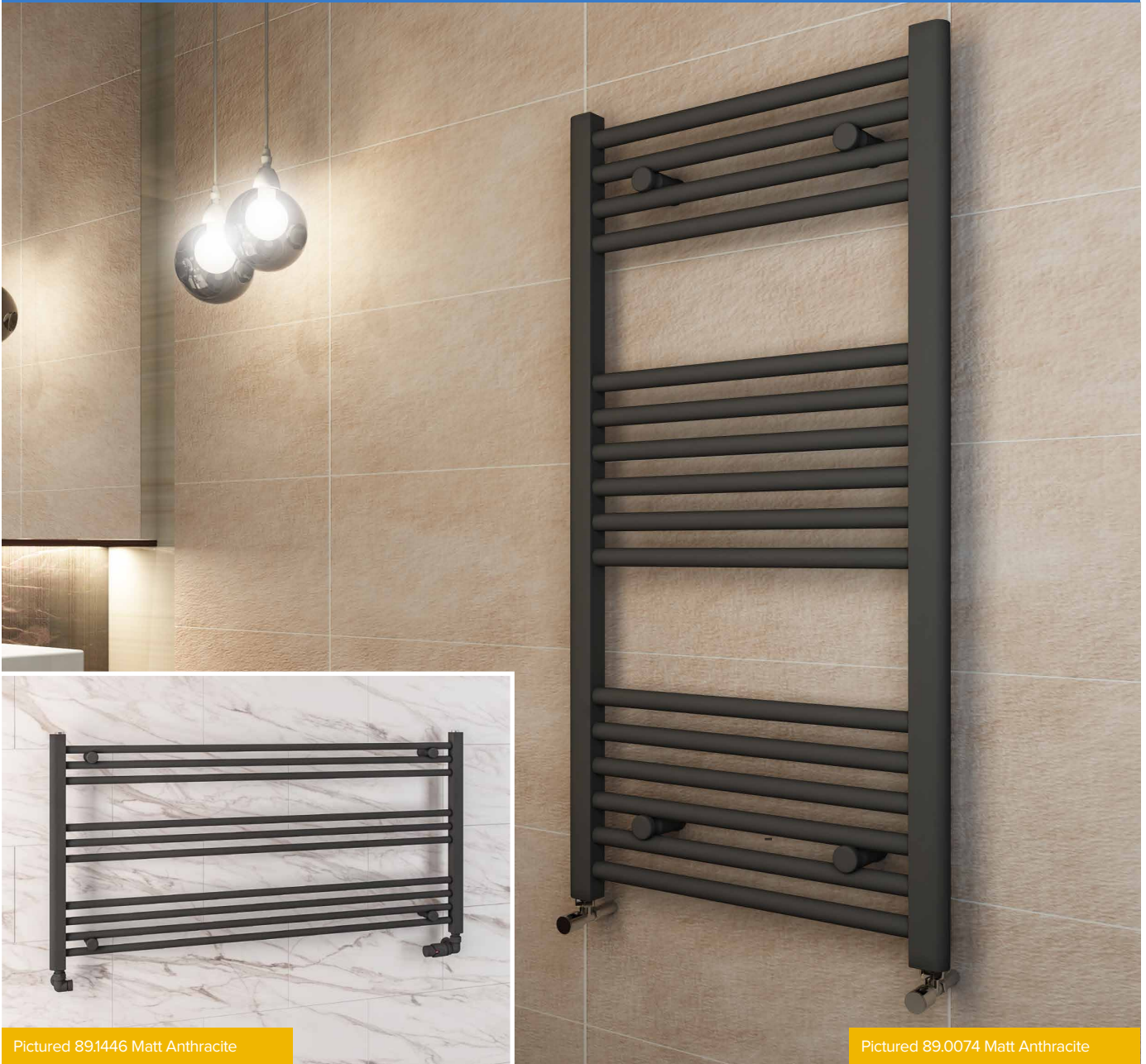

Pictured 89.1446 Matt Anthracite

Pictured 89.0074 Matt Anthracite

A contemporary straight towel radiator range which comes in chrome, matt anthracite, matt cobalt blue, matt black, matt grey, gloss white and matt white finishes. With a wide variety of sizes, this range not only adds to your bathroom with design simplicity but also keeps your towels warm.

### FEATURES

- 22mm diameter horizontal round tubes
  - Wide range of sizes to fit in all spaces
  - Horizontal sizes to fit under windows
  - Tested to BS EN 442 standards
  - 5 Year manufacturer's warranty\*
  - Can be single or dual fuel, or all electric
- \* With conditions

**Technical Tables  
& Drawings**  
Page 318-319



<p>Warranty</p> <p><b>5</b></p> <p>Year</p>	<p>Diameter (Ø)</p> <p><b>22</b></p> <p>MM Bars</p>	<p>Heating</p>	<p>All Electric</p>	<p>Dual-Fuel</p>
---	---	----------------	---------------------	------------------

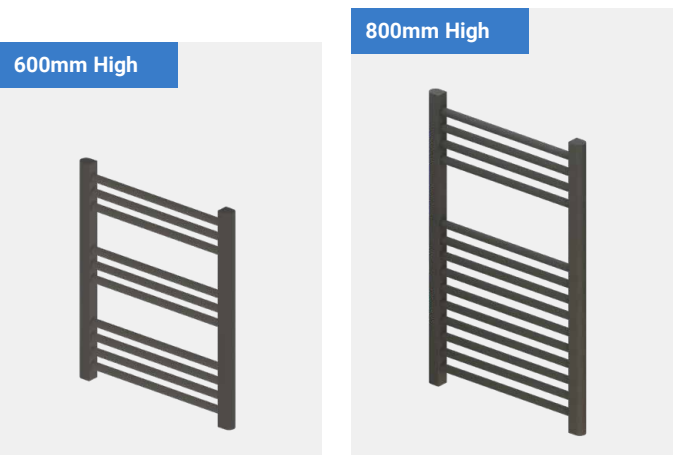

# Multirail Range

## WINGRAVE - STRAIGHT, MATT ANTHRACITE

### Wingrave - Straight Matt Anthracite 600mm Height

Size H x W	Watts	BTU	Element Output	Element Type	Code	£ Ex VAT	£ Inc VAT
600 x 300mm	204	697	100W	A, A+, D, E, F, G	89.0666	61.00	<b>73.20</b>
600 x 400mm	257	877	150W	A, A+, D, E, F, G	89.0667	63.00	<b>75.60</b>
600 x 500mm	309	1055	150W	A, A+, D, E, F, G	89.0668	69.00	<b>82.80</b>
600 x 600mm	358	1222	150W	A, A+, D, E, F, G	89.0669	72.00	<b>86.40</b>
600 x 1000mm	543	1853	300W	A, A+, D, E, F, G	89.1445	125.00	<b>150.00</b>
600 x 1200mm	629	2147	300W	A, A+, D, E, F, G	89.1446	137.00	<b>164.40</b>

### Wingrave - Straight Matt Anthracite 800mm Height

Size H x W	Watts	BTU	Element Output	Element Type	Code	£ Ex VAT	£ Inc VAT
800 x 300mm	266	908	150W	A, A+, D, E, F, G	89.0670	63.00	<b>75.60</b>
800 x 400mm	337	1150	150W	A, A+, D, E, F, G	89.0668	74.00	<b>88.80</b>
800 x 500mm	404	1379	150W	A, A+, D, E, F, G	89.0073	80.00	<b>96.00</b>
800 x 600mm	468	1597	300W	A, A+, D, E, F, G	89.0078	84.00	<b>100.80</b>

### Wingrave - Straight Matt Anthracite 1000mm Height

Size H x W	Watts	BTU	Element Output	Element Type	Code	£ Ex VAT	£ Inc VAT
1000 x 300mm	331	1130	150W	A, A+, D, E, F, G	89.0671	72.00	<b>86.40</b>
1000 x 400mm	419	1430	150W	A, A+, D, E, F, G	89.0669	84.00	<b>100.80</b>
1000 x 500mm	502	1713	300W	A, A+, D, E, F, G	89.0074	90.00	<b>108.00</b>
1000 x 600mm	582	1986	300W	A, A+, D, E, F, G	89.0079	97.00	<b>116.40</b>

### Wingrave - Straight Matt Anthracite 1200mm Height

Size H x W	Watts	BTU	Element Output	Element Type	Code	£ Ex VAT	£ Inc VAT
1200 x 300mm	398	1358	150W	A, A+, D, E, F, G	89.0672	83.00	<b>99.60</b>
1200 x 400mm	503	1717	300W	A, A+, D, E, F, G	89.0070	97.00	<b>116.40</b>
1200 x 500mm	604	2061	300W	A, A+, D, E, F, G	89.0075	101.00	<b>121.20</b>
1200 x 600mm	700	2389	300W	A, A+, D, E, F, G	89.0080	109.00	<b>130.80</b>

### Wingrave - Straight Matt Anthracite 1400mm Height

Size H x W	Watts	BTU	Element Output	Element Type	Code	£ Ex VAT	£ Inc VAT
1400 x 300mm	468	1597	150W	A, A+, D, E, F, G	89.0673	96.00	<b>115.20</b>
1400 x 400mm	592	2020	300W	A, A+, D, E, F, G	89.0533	109.00	<b>130.80</b>
1400 x 500mm	710	2423	300W	A, A+, D, E, F, G	89.0534	118.00	<b>141.60</b>
1400 x 600mm	824	2812	450W	A, A+, D, E, F, G	89.0535	126.00	<b>151.20</b>

### Wingrave - Straight Matt Anthracite 1600mm Height

Size H x W	Watts	BTU	Element Output	Element Type	Code	£ Ex VAT	£ Inc VAT
1600 x 300mm	542	1850	300W	A, A+, D, E, F, G	89.0674	100.00	<b>120.00</b>
1600 x 400mm	685	2338	300W	A, A+, D, E, F, G	89.0071	119.00	<b>142.80</b>
1600 x 500mm	821	2802	450W	A, A+, D, E, F, G	89.0076	128.00	<b>153.60</b>
1600 x 600mm	953	3252	450W	A, A+, D, E, F, G	89.0081	135.00	<b>162.00</b>

### Wingrave - Straight Matt Anthracite 1800mm Height

Size H x W	Watts	BTU	Element Output	Element Type	Code	£ Ex VAT	£ Inc VAT
1800 x 300mm	619	2113	300W	A, A+, D, E, F, G	89.0675	112.00	<b>134.40</b>
1800 x 400mm	782	2669	450W	A, A+, D, E, F, G	89.0072	130.00	<b>156.00</b>
1800 x 500mm	938	3201	450W	A, A+, D, E, F, G	89.0077	153.00	<b>183.60</b>
1800 x 600mm	1088	3713	600W	A, A+, D, E, F, G	89.0082	154.00	<b>184.80</b>

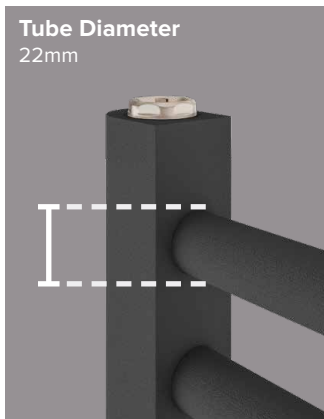

### Room Divider Bracket Sets

Page 311



### Robe Hooks & Hangers

Page 310



### Multi-Rail Hangers

Page 310



### Vent Caps

Page 313



### TECHNICAL INFORMATION

All measurements in Height by Width. Heat output based on  $\Delta T60^{\circ}C$ . Radiators that are electric only are restricted to the heat output of the elements. Element size can be increased to full capacity of rail if using element type D, E, F or G. (Type F & G Elements suitable for all electric only) For matching valves see pages 301-309. For indirect heating systems only. Tappings are approx. 44mm less than the width of the rail and approx. 65mm off the wall. Price includes radiator and wall fixing sets, valves extra.

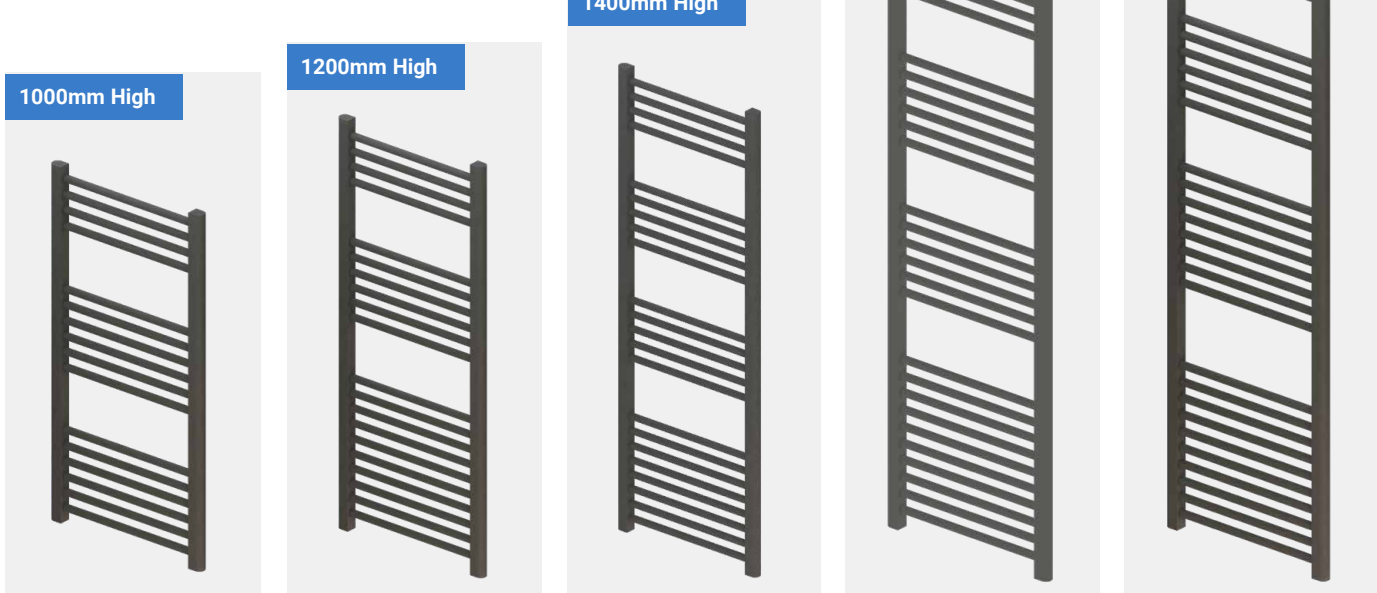

# Multirail Range

## WINGRAVE - STRAIGHT, MATT BLACK



Pictured 89.1447 Matt Black

Pictured 89.0606 Matt Black

A contemporary straight towel radiator range which comes in chrome, matt anthracite, matt cobalt blue, matt black, matt grey, gloss white and matt white finishes. With a wide variety of sizes, this range not only adds to your bathroom with design simplicity but also keeps your towels warm.

### FEATURES

- 22mm diameter horizontal round tubes
  - Wide range of sizes to fit in all spaces
  - Horizontal sizes to fit under windows
  - Tested to BS EN 442 standards
  - 5 Year manufacturer's warranty\*
  - Can be single or dual fuel, or all electric
- \* With conditions

**Technical Tables  
& Drawings**  
Page 318-319



<b>Warranty</b> <b>5</b> Year	<b>Diameter (Ø)</b> <b>22</b> MM Bars	<b>Heating</b> 	<b>All Electric</b> 	<b>Dual-Fuel</b> 
-------------------------------------	---	--------------------	-------------------------	----------------------

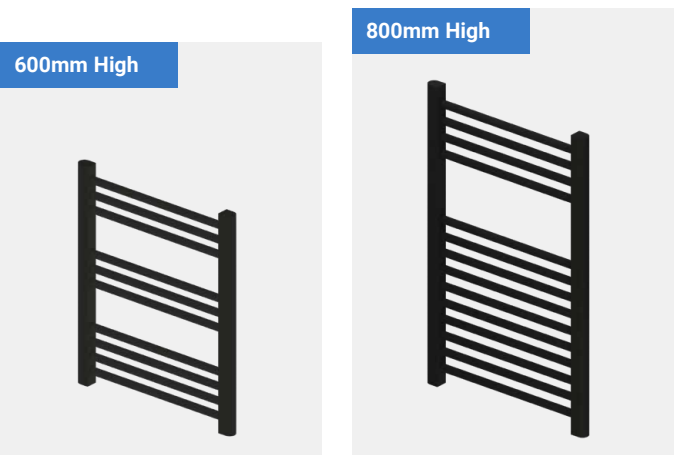



# Multirail Range

## WINGRAVE - STRAIGHT, MATT BLACK

### Wingrave - Straight Matt Black 600mm Height

Size H x W	Watts	BTU	Element Output	Element Type	Code	£ Ex VAT	£ Inc VAT
600 x 300mm	204	697	100W	A, A+, D, E, F, G	89.0676	61.00	73.20
600 x 400mm	257	877	150W	A, A+, D, E, F, G	89.0677	63.00	75.60
600 x 500mm	309	1055	150W	A, A+, D, E, F, G	89.0678	69.00	82.80
600 x 600mm	358	1222	150W	A, A+, D, E, F, G	89.0679	72.00	86.40
600 x 1000mm	543	1853	300W	A, A+, D, E, F, G	89.1447	125.00	150.00
600 x 1200mm	629	2147	300W	A, A+, D, E, F, G	89.1448	137.00	164.40

### Wingrave - Straight Matt Black 800mm Height

Size H x W	Watts	BTU	Element Output	Element Type	Code	£ Ex VAT	£ Inc VAT
800 x 300mm	266	908	150W	A, A+, D, E, F, G	89.0680	63.00	75.60
800 x 400mm	337	1150	150W	A, A+, D, E, F, G	89.0596	74.00	88.80
800 x 500mm	404	1379	150W	A, A+, D, E, F, G	89.0597	80.00	96.00
800 x 600mm	468	1597	300W	A, A+, D, E, F, G	89.0598	84.00	100.80

### Wingrave - Straight Matt Black 1000mm Height

Size H x W	Watts	BTU	Element Output	Element Type	Code	£ Ex VAT	£ Inc VAT
1000 x 300mm	331	1130	150W	A, A+, D, E, F, G	89.0681	72.00	86.40
1000 x 400mm	419	1430	150W	A, A+, D, E, F, G	89.0599	84.00	100.80
1000 x 500mm	502	1713	300W	A, A+, D, E, F, G	89.0600	90.00	108.00
1000 x 600mm	582	1986	300W	A, A+, D, E, F, G	89.0601	97.00	116.40

### Wingrave - Straight Matt Black 1200mm Height

Size H x W	Watts	BTU	Element Output	Element Type	Code	£ Ex VAT	£ Inc VAT
1200 x 300mm	398	1358	150W	A, A+, D, E, F, G	89.0682	83.00	99.60
1200 x 400mm	503	1717	300W	A, A+, D, E, F, G	89.0602	97.00	116.40
1200 x 500mm	604	2061	300W	A, A+, D, E, F, G	89.0603	101.00	121.20
1200 x 600mm	700	2389	300W	A, A+, D, E, F, G	89.0604	109.00	130.80

### Wingrave - Straight Matt Black 1400mm Height

Size H x W	Watts	BTU	Element Output	Element Type	Code	£ Ex VAT	£ Inc VAT
1400 x 300mm	468	1597	150W	A, A+, D, E, F, G	89.0683	96.00	115.20
1400 x 400mm	592	2020	300W	A, A+, D, E, F, G	89.0605	109.00	130.80
1400 x 500mm	710	2423	300W	A, A+, D, E, F, G	89.0606	118.00	141.60
1400 x 600mm	824	2812	450W	A, A+, D, E, F, G	89.0607	126.00	151.20

### Wingrave - Straight Matt Black 1600mm Height

Size H x W	Watts	BTU	Element Output	Element Type	Code	£ Ex VAT	£ Inc VAT
1600 x 300mm	542	1850	300W	A, A+, D, E, F, G	89.0684	100.00	120.00
1600 x 400mm	685	2338	300W	A, A+, D, E, F, G	89.0608	119.00	142.80
1600 x 500mm	821	2802	450W	A, A+, D, E, F, G	89.0609	128.00	153.60
1600 x 600mm	953	3252	450W	A, A+, D, E, F, G	89.0610	135.00	162.00

### Wingrave - Straight Matt Black 1800mm Height

Size H x W	Watts	BTU	Element Output	Element Type	Code	£ Ex VAT	£ Inc VAT
1800 x 300mm	619	2113	300W	A, A+, D, E, F, G	89.0685	112.00	134.40
1800 x 400mm	782	2669	450W	A, A+, D, E, F, G	89.0611	130.00	156.00
1800 x 500mm	938	3201	450W	A, A+, D, E, F, G	89.0612	153.00	183.60
1800 x 600mm	1088	3713	600W	A, A+, D, E, F, G	89.0613	154.00	184.80

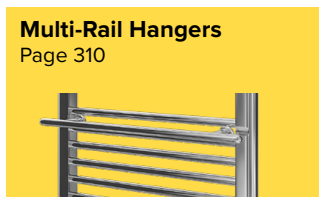
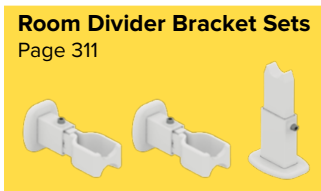
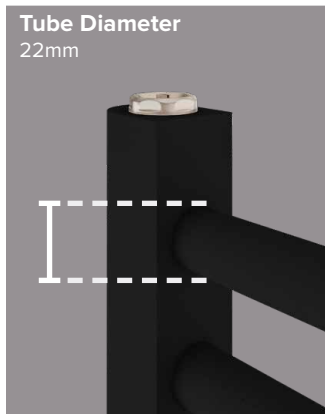

### TECHNICAL INFORMATION

All measurements in Height by Width. Heat output based on  $\Delta T60^{\circ}\text{C}$ . Radiators that are electric only are restricted to the heat output of the elements. Element size can be increased to full capacity of rail if using element type D, E, F or G. (Type F & G Elements suitable for all electric only) For element types see pages 288-300. For matching valves see pages 301-309. For indirect heating systems only. Tappings are approx. 44mm less than the width of the rail and approx. 65mm off the wall. Price includes radiator and wall fixing sets, valves extra.

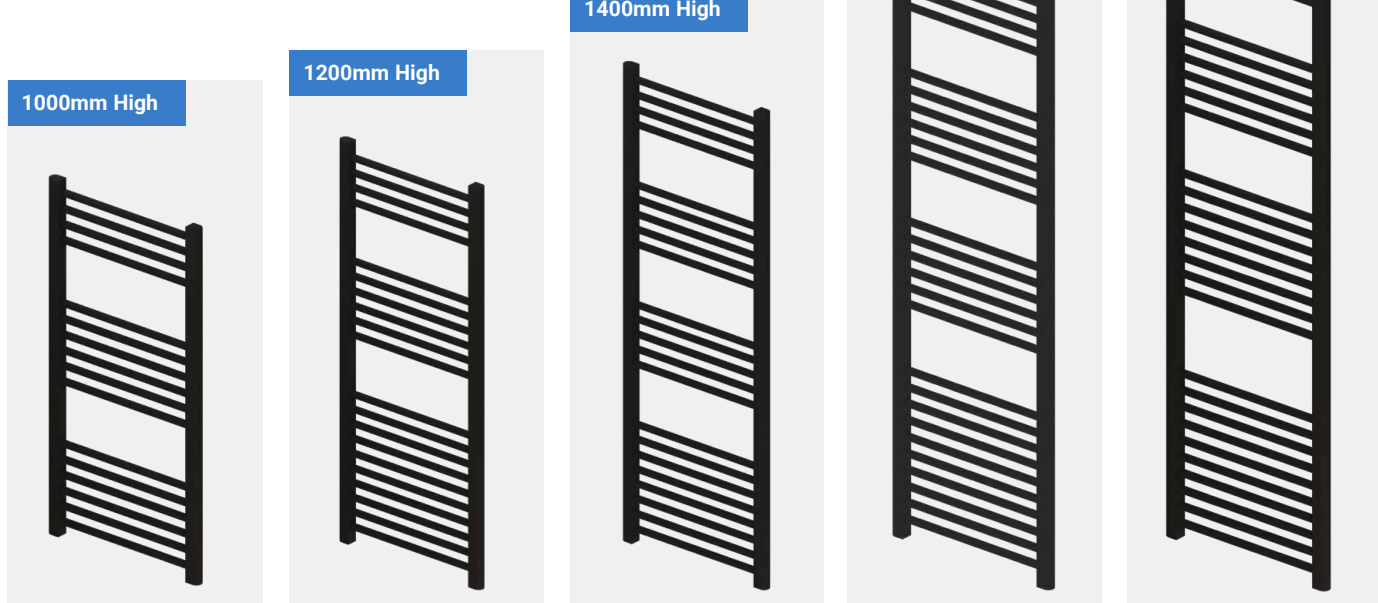

# Multirail Range

## WINGRAVE - STRAIGHT, MATT GREY



**Technical Tables & Drawings**  
Page 318-319

Pictured 89.1443 Matt Grey

A contemporary straight towel radiator range which comes in chrome, matt anthracite, matt cobalt blue, matt black, matt grey, gloss white and matt white finishes. With a wide variety of sizes, this range not only adds to your bathroom with design simplicity but also keeps your towels warm.

**FEATURES**

- 22mm diameter horizontal round tubes
  - Wide range of sizes to fit in all spaces
  - Horizontal sizes to fit under windows
  - Tested to BS EN 442 standards
  - 5 Year manufacturer's warranty\*
  - Can be single or dual fuel, or all electric
- \* With conditions

**Vent Caps**  
Page 313



Warranty

**5**

Year

Diameter (Ø)

**22**

MM Bars

Heating

All Electric

Dual-Fuel



Pictured 89.1425 Matt Grey

Wingrave - Straight Matt Grey 600mm Height							
Size H x W	Watts	BTU	Element Output	Element Type	Code	£ Ex VAT	£ Inc VAT
600 x 300mm	204	697	100W	A, A+, D, E, F, G	89.1411	61.00	<b>73.20</b>
600 x 400mm	257	877	150W	A, A+, D, E, F, G	89.1412	63.00	<b>75.60</b>
600 x 500mm	309	1055	150W	A, A+, D, E, F, G	89.1413	69.00	<b>82.80</b>
600 x 600mm	358	1222	150W	A, A+, D, E, F, G	89.1414	72.00	<b>86.40</b>
600 x 1000mm	543	1853	300W	A, A+, D, E, F, G	89.1443	125.00	<b>150.00</b>
600 x 1200mm	629	2147	300W	A, A+, D, E, F, G	89.1444	137.00	<b>164.40</b>

Wingrave - Straight Matt Grey 1200mm Height							
Size H x W	Watts	BTU	Element Output	Element Type	Code	£ Ex VAT	£ Inc VAT
1200 x 300mm	398	1358	150W	A, A+, D, E, F, G	89.1423	83.00	<b>99.60</b>
1200 x 400mm	503	1717	300W	A, A+, D, E, F, G	89.1424	97.00	<b>116.40</b>
1200 x 500mm	604	2061	300W	A, A+, D, E, F, G	89.1425	101.00	<b>121.20</b>
1200 x 600mm	700	2389	300W	A, A+, D, E, F, G	89.1426	109.00	<b>130.80</b>

Wingrave - Straight Matt Grey 800mm Height							
Size H x W	Watts	BTU	Element Output	Element Type	Code	£ Ex VAT	£ Inc VAT
800 x 300mm	266	908	150W	A, A+, D, E, F, G	89.1415	63.00	<b>75.60</b>
800 x 400mm	337	1150	150W	A, A+, D, E, F, G	89.1416	74.00	<b>88.80</b>
800 x 500mm	404	1379	150W	A, A+, D, E, F, G	89.1417	80.00	<b>96.00</b>
800 x 600mm	468	1597	300W	A, A+, D, E, F, G	89.1418	84.00	<b>100.80</b>

Wingrave - Straight Matt Grey 1400mm Height							
Size H x W	Watts	BTU	Element Output	Element Type	Code	£ Ex VAT	£ Inc VAT
1400 x 300mm	468	1597	150W	A, A+, D, E, F, G	89.1427	96.00	<b>115.20</b>
1400 x 400mm	592	2020	300W	A, A+, D, E, F, G	89.1428	109.00	<b>130.80</b>
1400 x 500mm	710	2423	300W	A, A+, D, E, F, G	89.1429	118.00	<b>141.60</b>
1400 x 600mm	824	2812	450W	A, A+, D, E, F, G	89.1430	126.00	<b>151.20</b>

Wingrave - Straight Matt Grey 1000mm Height							
Size H x W	Watts	BTU	Element Output	Element Type	Code	£ Ex VAT	£ Inc VAT
1000 x 300mm	331	1130	150W	A, A+, D, E, F, G	89.1419	72.00	<b>86.40</b>
1000 x 400mm	419	1430	150W	A, A+, D, E, F, G	89.1420	84.00	<b>100.80</b>
1000 x 500mm	502	1713	300W	A, A+, D, E, F, G	89.1421	90.00	<b>108.00</b>
1000 x 600mm	582	1986	300W	A, A+, D, E, F, G	89.1422	97.00	<b>116.40</b>

Wingrave - Straight Matt Grey 1600mm Height							
Size H x W	Watts	BTU	Element Output	Element Type	Code	£ Ex VAT	£ Inc VAT
1600 x 300mm	542	1850	300W	A, A+, D, E, F, G	89.1431	100.00	<b>120.00</b>
1600 x 400mm	685	2338	300W	A, A+, D, E, F, G	89.1432	119.00	<b>142.80</b>
1600 x 500mm	821	2802	450W	A, A+, D, E, F, G	89.1433	128.00	<b>153.60</b>
1600 x 600mm	953	3252	450W	A, A+, D, E, F, G	89.1434	135.00	<b>162.00</b>

**TECHNICAL INFORMATION**

All measurements in Height by Width. Heat output based on  $\Delta T60^{\circ}C$ . Radiators that are electric only are restricted to the heat output of the elements. Element size can be increased to full capacity of rail if using element type D, E, F or G. (Type F & G Elements suitable for all electric only) For element types see pages 288-300. For matching valves see pages 301-309. For indirect heating systems only. Tappings are approx. 44mm less than the width of the rail and approx. 65mm off the wall. Price includes radiator and wall fixing sets, valves extra.

Wingrave - Straight Matt Grey 1800mm Height							
Size H x W	Watts	BTU	Element Output	Element Type	Code	£ Ex VAT	£ Inc VAT
1800 x 300mm	619	2113	300W	A, A+, D, E, F, G	89.1435	112.00	<b>134.40</b>
1800 x 400mm	782	2669	450W	A, A+, D, E, F, G	89.1436	130.00	<b>156.00</b>
1800 x 500mm	938	3201	450W	A, A+, D, E, F, G	89.1437	153.00	<b>183.60</b>
1800 x 600mm	1088	3713	600W	A, A+, D, E, F, G	89.1438	154.00	<b>184.80</b>

# Multirail Range

## WINGRAVE - STRAIGHT, MATT COBALT BLUE



Pictured 89.1607 Matt Cobalt Blue

A modern ladder towel rail in a stunning matt cobalt blue finish. This rail will add a touch of class to finish off your bathroom.

### FEATURES

- 22mm diameter horizontal round tubes
  - Wide range of sizes to fit in all spaces
  - Tested to BS EN 442 standards
  - 5 Year manufacturer's warranty\*
  - Can be single or dual fuel, or all electric
- \* With conditions

Technical Tables  
& Drawings  
Page 318-319



Pictured 89.1602 Matt Cobalt Blue

Tube Diameter  
22mm



### Wingrave - Straight Matt Cobalt Blue

Size H x W	Watts	BTU	Element Output	Element Type	Code	£ Ex VAT	£ Inc VAT
1200 x 500mm	604	2061	300W	A, A+, D, E, F, G	89.1602	101.00	121.20
1200 x 600mm	700	2389	300W	A, A+, D, E, F, G	89.1603	109.00	130.80
1600 x 500mm	821	2802	450W	A, A+, D, E, F, G	89.1604	128.00	153.60
1600 x 600mm	953	3252	450W	A, A+, D, E, F, G	89.1605	135.00	162.00
1800 x 500mm	938	3201	450W	A, A+, D, E, F, G	89.1606	153.00	183.60
1800 x 600mm	1088	3713	600W	A, A+, D, E, F, G	89.1607	154.00	184.80

### TECHNICAL INFORMATION

All measurements in Height by Width. Heat output based on  $\Delta T60^{\circ}\text{C}$ . Radiators that are electric only are restricted to the heat output of the elements. Element size can be increased to full capacity of rail if using element type D, E, F or G. (Type F & G Elements suitable for all electric only) For element types see pages 288-300. For matching valves see pages 301-309. For indirect heating systems only. Tappings are approx. 44mm less than the width of the rail and approx. 65mm off the wall. Price includes radiator and wall fixing sets, valves extra.

Warranty  
**5**  
Year

Diameter (Ø)  
**22**  
MM Bars

Heating

All Electric

Dual-Fuel

# Multirail Range

## WINGRAVE - CURVED CHROME

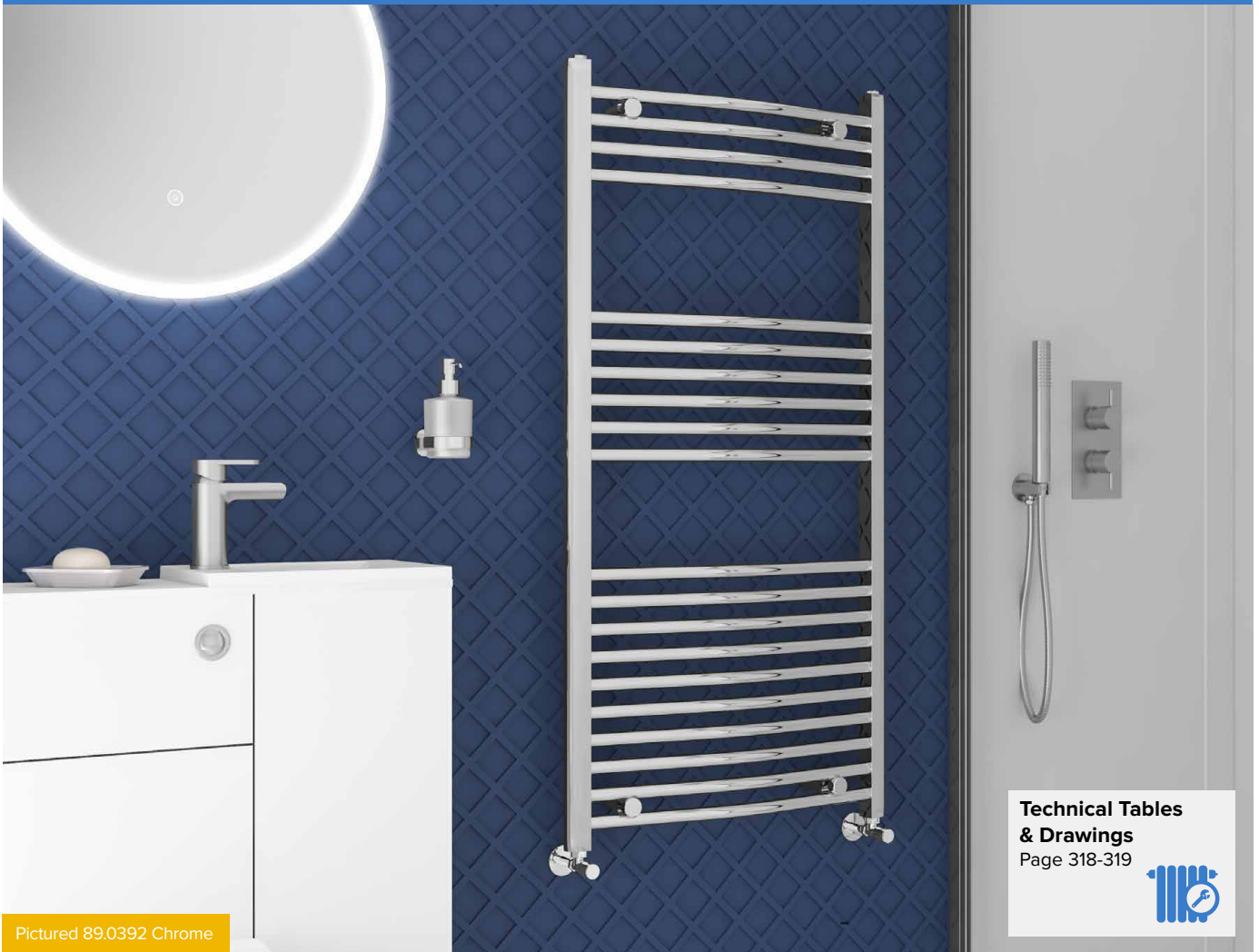

Pictured 89.0392 Chrome

Technical Tables  
& Drawings  
Page 318-319



Warranty

# 5

Year

Diameter (Ø)

# 22

MM Bars

Heating

All Electric

Dual-Fuel

A high quality contemporary range available in a curved design and chrome finish. Available with robe hook accessories. This range is the ultimate in simplicity of style and practicality for your bathroom, keeping your towels warm.

### FEATURES

- 22mm diameter horizontal round tubes
- Tested to BS EN 442 standards
- 5 Year manufacturer's warranty\*
- Can be single or dual fuel, or all electric
- \* With conditions

### D Shape Vent Caps

Page 313



### Radiator Valves

Page 301-309



### TECHNICAL INFORMATION

All measurements in Height by Width. Heat output based on ▲T60°C. Radiators that are electric only are restricted to the heat output of the elements. Element size can be increased to full capacity of rail if using element type D, E, F or G. (Type F & G Elements suitable for all electric only) For element types see pages 288-300. For matching valves see pages 301-309. For indirect heating systems only. Tappings are approx. 44mm less than the width of the rail and approx. 65mm off the wall. Price includes radiator and wall fixing sets, valves extra.

### Wingrave - Curved Chrome 800mm Height

Size H x W	Watts	BTU	Element Output	Element Type	Code	£ Ex VAT	£ Inc VAT
800 x 400mm	217	741	150W	A, A+, D, E, F, G	89.0384	107.00	128.40
800 x 500mm	261	891	150W	A, A+, D, E, F, G	89.0385	124.00	148.80
800 x 600mm	303	1034	150W	A, A+, D, E, F, G	89.0386	132.00	158.40

### Wingrave - Curved Chrome 1000mm Height

Size H x W	Watts	BTU	Element Output	Element Type	Code	£ Ex VAT	£ Inc VAT
1000 x 400mm	269	918	150W	A, A+, D, E, F, G	89.0387	128.00	153.60
1000 x 500mm	324	1106	150W	A, A+, D, E, F, G	89.0388	139.00	166.80
1000 x 600mm	376	1283	150W	A, A+, D, E, F, G	89.0389	155.00	186.00

### Wingrave - Curved Chrome 1200mm Height

Size H x W	Watts	BTU	Element Output	Element Type	Code	£ Ex VAT	£ Inc VAT
1200 x 400mm	324	1106	150W	A, A+, D, E, F, G	89.0390	149.00	178.80
1200 x 500mm	390	1331	150W	A, A+, D, E, F, G	89.0391	164.00	196.80
1200 x 600mm	454	1550	300W	A, A+, D, E, F, G	89.0392	182.00	218.40

### Wingrave - Curved Chrome 1600mm Height

Size H x W	Watts	BTU	Element Output	Element Type	Code	£ Ex VAT	£ Inc VAT
1600 x 400mm	446	1522	150W	A, A+, D, E, F, G	89.0393	194.00	232.80
1600 x 500mm	537	1833	300W	A, A+, D, E, F, G	89.0394	213.00	255.60
1600 x 600mm	624	2130	300W	A, A+, D, E, F, G	89.0395	231.00	277.20

### Wingrave - Curved Chrome 1800mm Height

Size H x W	Watts	BTU	Element Output	Element Type	Code	£ Ex VAT	£ Inc VAT
1800 x 400mm	514	1754	300W	A, A+, D, E, F, G	89.0396	217.00	260.40
1800 x 500mm	618	2109	300W	A, A+, D, E, F, G	89.0397	240.00	288.00
1800 x 600mm	719	2454	450W	A, A+, D, E, F, G	89.0398	258.00	309.60

# Multirail Range

## WINGRAVE - CURVED GLOSS WHITE

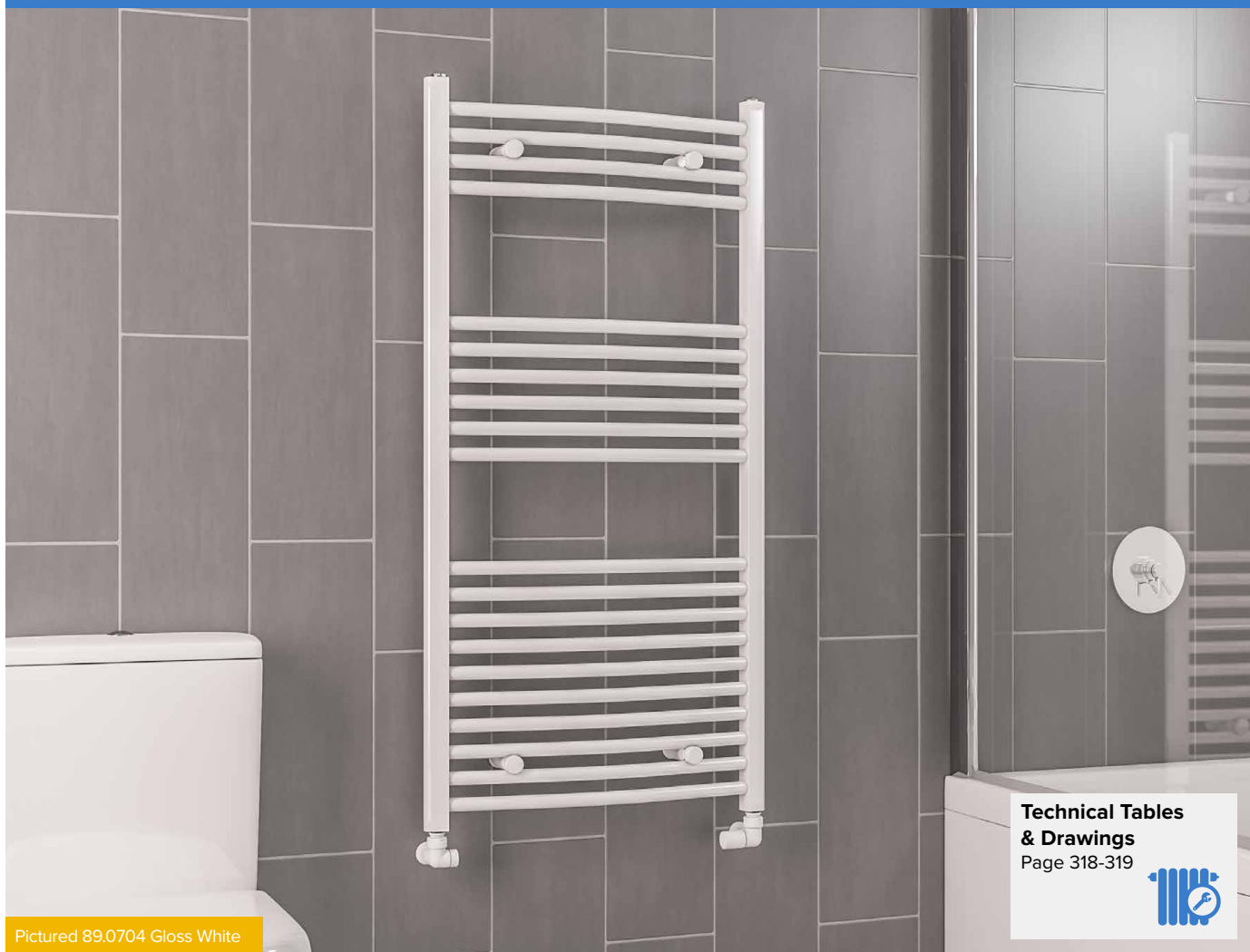

Pictured 89.0704 Gloss White

Warranty

# 5

Year

Diameter (Ø)

# 22

MM Bars

Heating

All Electric

Dual-Fuel

A high quality contemporary range available in a curved gloss white finish. Available with robe hook accessories. This range is the ultimate in simplicity of style and practicality for your bathroom, keeping your towels warm.

**FEATURES**

- 22mm diameter horizontal round tubes
- Tested to BS EN 442 standards
- 5 Year manufacturer's warranty\*
- Can be single or dual fuel, or all electric
- \* With conditions

**Radiator Valves**  
Page 301-309

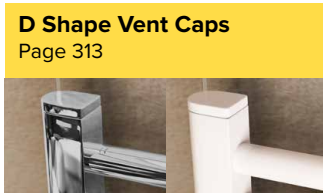

**D Shape Vent Caps**  
Page 313

**TECHNICAL INFORMATION**

All measurements in Height by Width. Heat output based on ▲T60°C. Radiators that are electric only are restricted to the heat output of the elements. Element size can be increased to full capacity of rail if using element type D, E, F or G. (Type F & G Elements suitable for all electric only) For element types see pages 288-300. For matching valves see pages 301-309. For indirect heating systems only. Tappings are approx. 44mm less than the width of the rail and approx. 65mm off the wall. Price includes radiator and wall fixing sets, valves extra.

**Technical Tables & Drawings**  
Page 318-319



Wingrave - Curved Gloss White 800mm Height							
Size H x W	Watts	BTU	Element Output	Element Type	Code	£ Ex VAT	£ Inc VAT
800 x 400mm	337	1150	150W	A, A+, D, E, F, G	89.0696	72.00	86.40
800 x 500mm	404	1379	150W	A, A+, D, E, F, G	89.0697	78.00	93.60
800 x 600mm	468	1597	300W	A, A+, D, E, F, G	89.0698	83.00	99.60

Wingrave - Curved Gloss White 1000mm Height							
Size H x W	Watts	BTU	Element Output	Element Type	Code	£ Ex VAT	£ Inc VAT
1000 x 400mm	419	1430	150W	A, A+, D, E, F, G	89.0699	83.00	99.60
1000 x 500mm	502	1713	300W	A, A+, D, E, F, G	89.0700	89.00	106.80
1000 x 600mm	582	1986	300W	A, A+, D, E, F, G	89.0701	92.00	110.40

Wingrave - Curved Gloss White 1200mm Height							
Size H x W	Watts	BTU	Element Output	Element Type	Code	£ Ex VAT	£ Inc VAT
1200 x 400mm	503	1717	300W	A, A+, D, E, F, G	89.0702	92.00	110.40
1200 x 500mm	604	2061	300W	A, A+, D, E, F, G	89.0703	98.00	117.60
1200 x 600mm	700	2389	300W	A, A+, D, E, F, G	89.0704	103.00	123.60

Wingrave - Curved Gloss White 1600mm Height							
Size H x W	Watts	BTU	Element Output	Element Type	Code	£ Ex VAT	£ Inc VAT
1600 x 400mm	685	2338	300W	A, A+, D, E, F, G	89.0705	113.00	135.60
1600 x 500mm	821	2802	450W	A, A+, D, E, F, G	89.0706	125.00	150.00
1600 x 600mm	953	3252	450W	A, A+, D, E, F, G	89.0707	132.00	158.40

Wingrave - Curved Gloss White 1800mm Height							
Size H x W	Watts	BTU	Element Output	Element Type	Code	£ Ex VAT	£ Inc VAT
1800 x 400mm	782	2669	450W	A, A+, D, E, F, G	89.0708	128.00	153.60
1800 x 500mm	938	3201	450W	A, A+, D, E, F, G	89.0709	144.00	172.80
1800 x 600mm	1088	3713	600W	A, A+, D, E, F, G	89.0710	146.00	175.20

# Multirail Range

## BIAVA MULTIRAIL - STRAIGHT GLOSS WHITE



Pictured 41.0278 Gloss White

## BIAVA MULTIRAIL - STRAIGHT CHROME



Pictured 41.0272 Chrome

### Biava Multirail - Straight Gloss White

Size H x W	Watts	BTU	Element Output	Element Type	Code	£ Ex VAT	£ Inc VAT
360x400mm	145	495	100W	A, A+, D, E, F, G	41.0278	62.00	<b>74.40</b>
688x450mm	344	1174	150W	A, A+, D, E, F, G	41.0279	112.00	<b>134.40</b>
688x600mm	438	1494	150W	A, A+, D, E, F, G	41.0280	116.00	<b>139.20</b>
688x750mm	532	1815	300W	A, A+, D, E, F, G	41.0281	119.00	<b>142.80</b>
1118x450mm	546	1863	300W	A, A+, D, E, F, G	41.0282	135.00	<b>162.00</b>
1118x600mm	695	2371	300W	A, A+, D, E, F, G	41.0283	138.00	<b>165.60</b>
1118x750mm	843	2876	450W	A, A+, D, E, F, G	41.0284	150.00	<b>180.00</b>
1720x450mm	843	2876	450W	A, A+, D, E, F, G	41.0285	187.00	<b>224.40</b>
1720x600mm	1072	3658	600W	A, A+, D, E, F, G	41.0286	195.00	<b>234.00</b>
1720x750mm	1302	4442	750W	A, A+, D, E, F, G	41.0287	208.00	<b>249.60</b>

### Biava Multirail - Straight Chrome

Size H x W	Watts	BTU	Element Output	Element Type	Code	£ Ex VAT	£ Inc VAT
360x400mm	113	386	N/A	N/A	41.0268	100.00	<b>120.00</b>
688x450mm	270	921	150W	A, A+, D, E, F, G	41.0269	207.00	<b>248.40</b>
688x600mm	344	1174	150W	A, A+, D, E, F, G	41.0270	231.00	<b>277.20</b>
688x750mm	418	1426	150W	A, A+, D, E, F, G	41.0271	258.00	<b>309.60</b>
1118x450mm	430	1467	150W	A, A+, D, E, F, G	41.0272	259.00	<b>310.80</b>
1118x600mm	546	1863	300W	A, A+, D, E, F, G	41.0273	283.00	<b>339.60</b>
1118x750mm	663	2262	300W	A, A+, D, E, F, G	41.0274	306.00	<b>367.20</b>
1720x450mm	663	2262	300W	A, A+, D, E, F, G	41.0275	359.00	<b>430.80</b>
1720x600mm	843	2876	450W	A, A+, D, E, F, G	41.0276	372.00	<b>446.40</b>
1720x750mm	1024	3494	600W	A, A+, D, E, F, G	41.0277	405.00	<b>486.00</b>

A high quality contemporary range available in straight and curved designs, and gloss white or chrome finishes. Available with towel hangers or robe hook accessories. This range is the ultimate in simplicity of style and practicality for your bathroom, keeping your towels warm.

#### FEATURES

- 22mm diameter horizontal round tubes
- Tested to BS EN 442 standards
- 5 Year manufacturer's warranty\*
- Can be single or dual fuel, or all electric
- \* With conditions

#### Technical Tables & Drawings

Page 318-319



#### TECHNICAL INFORMATION

All measurements in Height by Width. Heat output based on  $\Delta T60^{\circ}\text{C}$ . Radiators that are electric only are restricted to the heat output of the elements. Element size can be increased to full capacity of rail if using element type D, E, F or G. (Type F & G Elements suitable for all electric only) For element types see pages 288-300. For matching valves see pages 301-309. For indirect heating systems only. Tappings are approx. 50mm less than the width of the rail and approx. 75mm off the wall. Price includes radiator and wall fixing sets, valves extra.

Warranty

**5**

Year

Diameter (Ø)

**22**

MM Bars

Heating

All Electric

Dual-Fuel

#### Room Divider Bracket Sets

Page 311

#### Robe Hooks

Page 310

#### Round Vent Caps

Page 313

#### Multi-Rail Hangers

Page 310

# Multirail Range

## BIAVA MULTIRAIL - CURVED CHROME



Pictured 41.0296 Chrome

## BIAVA MULTIRAIL - CURVED GLOSS WHITE



Pictured 41.0303 Gloss White

### Biava Multirail - Curved Chrome

Size H x W	Watts	BTU	Element Output	Element Type	Code	£ Ex VAT	£ Inc VAT
360x400mm	114	389	N/A	N/A	41.0288	96.00	115.20
688x450mm	273	931	150W	A, A+, D, E, F, G	41.0289	229.00	274.80
688x600mm	347	1184	150W	A, A+, D, E, F, G	41.0290	257.00	308.40
688x750mm	421	1436	150W	A, A+, D, E, F, G	41.0291	283.00	339.60
1118x450mm	433	1477	150W	A, A+, D, E, F, G	41.0292	284.00	340.80
1118x600mm	549	1873	300W	A, A+, D, E, F, G	41.0293	308.00	369.60
1118x750mm	666	2272	300W	A, A+, D, E, F, G	41.0294	339.00	406.80
1720x450mm	668	2279	300W	A, A+, D, E, F, G	41.0295	404.00	484.80
1720x600mm	848	2893	450W	A, A+, D, E, F, G	41.0296	410.00	492.00
1720x750mm	1029	3511	600W	A, A+, D, E, F, G	41.0297	444.00	532.80

### Biava Multirail - Curved Gloss White

Size H x W	Watts	BTU	Element Output	Element Type	Code	£ Ex VAT	£ Inc VAT
360x400mm	145	495	100W	A, A+, D, E, F, G	41.0298	63.00	75.60
688x450mm	347	1184	150W	A, A+, D, E, F, G	41.0299	128.00	153.60
688x600mm	440	1501	150W	A, A+, D, E, F, G	41.0300	131.00	157.20
688x750mm	535	1825	300W	A, A+, D, E, F, G	41.0301	132.00	158.40
1118x450mm	550	1877	300W	A, A+, D, E, F, G	41.0302	146.00	175.20
1118x600mm	699	2385	300W	A, A+, D, E, F, G	41.0303	150.00	180.00
1118x750mm	846	2887	450W	A, A+, D, E, F, G	41.0304	162.00	194.40
1720x450mm	849	2897	450W	A, A+, D, E, F, G	41.0305	208.00	249.60
1720x600mm	1078	3678	600W	A, A+, D, E, F, G	41.0306	215.00	258.00
1720x750mm	1307	4459	750W	A, A+, D, E, F, G	41.0307	230.00	276.00

A high quality contemporary range available in straight and curved designs, and gloss white or chrome finishes. Available with towel hangers or robe hook accessories. This range is the ultimate in simplicity of style and practicality for your bathroom, keeping your towels warm.

#### FEATURES

- 22mm diameter horizontal round tubes
- Tested to BS EN 442 standards
- 5 Year manufacturer's warranty\*
- Can be single or dual fuel, or all electric
- \* With conditions

Technical Tables & Drawings  
Page 318-319



Warranty

5

Year

Diameter (Ø)

22

MM Bars

Heating

All Electric

Dual-Fuel

#### TECHNICAL INFORMATION

All measurements in Height by Width. Heat output based on  $\Delta T60^{\circ}C$ . Radiators that are electric only are restricted to the heat output of the elements. Element size can be increased to full capacity of rail if using element type D, E, F or G. (Type F & G Elements suitable for all electric only) For element types see pages 288-300. For matching valves see pages 301-309. For indirect heating systems only. Tappings are approx. 50mm less than the width of the rail and approx. 75mm off the wall. Price includes radiator and wall fixing sets, valves extra.

#### Round Vent Caps

Page 313



#### Robe Hooks

Page 310

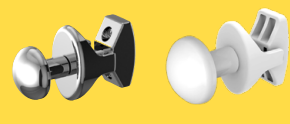

# Multirail Range

## WESTWARD - STRAIGHT

High Output 

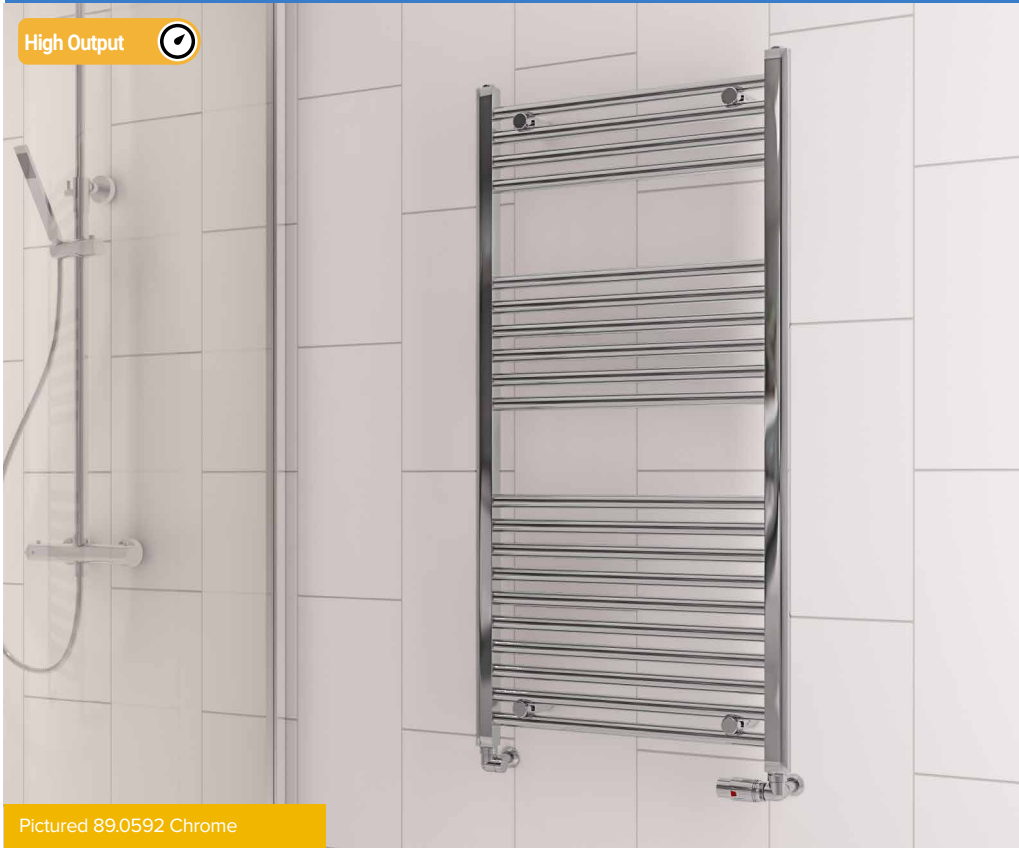

Pictured 89.0592 Chrome

### D Shape Vent Caps

Page 313



### Towel Hangers

Page 310



### Room Divider Bracket Sets

Page 311

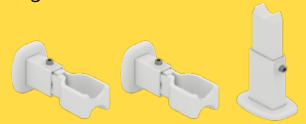

### Robe Hooks

Page 310

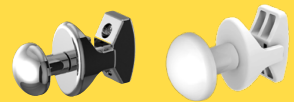

### Multi-Rail Hangers

Page 310



### Tube Diameter

25mm

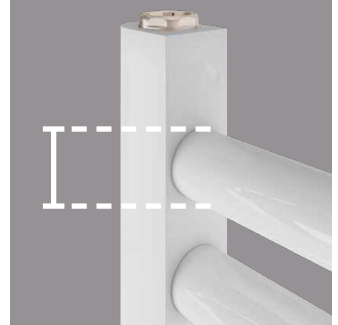

Warranty

**5**  
Year

Diameter (Ø)

**25**  
MM Bars

Heating



All Electric



Dual-Fuel



Pictured 89.0576 Gloss White

In addition to the Wingrave & Wendover ranges, this straight multirail boasts a higher output for the larger bathrooms. **Each horizontal tube is 25mm diameter, which produces a higher heat output in less space compared to a standard 22mm tube.**

### FEATURES

- 25mm diameter horizontal round tubes
  - Tested to BS EN 442 standards
  - 5 Year manufacturer's warranty\*
  - Can be single or dual fuel, or all electric
- \* With conditions



# Multirail Range

## WESTWARD - STRAIGHT

### Gloss White

#### Westward - Straight Gloss White 600mm Height

Size H x W	Watts	BTU	Element Output	Element Type	Code	£ Ex VAT	£ Inc VAT
600 x 500mm	371	1266	150W	A, A+, D, E, F, G	89.0572	80.00	<b>96.00</b>
600 x 600mm	434	1481	150W	A, A+, D, E, F, G	89.0573	86.00	<b>103.20</b>
600 x 800mm	560	1911	300W	A, A+, D, E, F, G	89.0574	101.00	<b>121.20</b>

#### Westward - Straight Gloss White 800mm Height

Size H x W	Watts	BTU	Element Output	Element Type	Code	£ Ex VAT	£ Inc VAT
800 x 400mm	399	1361	150W	A, A+, D, E, F, G	89.0575	79.00	<b>94.80</b>
800 x 500mm	479	1634	300W	A, A+, D, E, F, G	89.0576	86.00	<b>103.20</b>
800 x 600mm	599	1907	300W	A, A+, D, E, F, G	89.0577	89.00	<b>106.80</b>

#### Westward - Straight Gloss White 1200mm Height

Size H x W	Watts	BTU	Element Output	Element Type	Code	£ Ex VAT	£ Inc VAT
1200 x 400mm	550	1877	300W	A, A+, D, E, F, G	89.0578	101.00	<b>121.20</b>
1200 x 500mm	660	2252	300W	A, A+, D, E, F, G	89.0579	109.00	<b>130.80</b>
1200 x 600mm	768	2621	450W	A, A+, D, E, F, G	89.0580	118.00	<b>141.60</b>

#### Westward - Straight Gloss White 1800mm Height

Size H x W	Watts	BTU	Element Output	Element Type	Code	£ Ex VAT	£ Inc VAT
1800 x 400mm	816	2784	450W	A, A+, D, E, F, G	89.0581	139.00	<b>166.80</b>
1800 x 500mm	978	3337	600W	A, A+, D, E, F, G	89.0582	161.00	<b>193.20</b>
1800 x 600mm	1140	3890	600W	A, A+, D, E, F, G	89.0583	162.00	<b>194.40</b>

### Chrome

#### Westward - Straight Chrome 600mm Height

Size H x W	Watts	BTU	Element Output	Element Type	Code	£ Ex VAT	£ Inc VAT
600 x 500mm	245	836	150W	A, A+, D, E, F, G	89.0584	125.00	<b>150.00</b>
600 x 600mm	287	979	150W	A, A+, D, E, F, G	89.0585	137.00	<b>164.40</b>
600 x 800mm	371	1266	150W	A, A+, D, E, F, G	89.0586	162.00	<b>194.40</b>

#### Westward - Straight Chrome 800mm Height

Size H x W	Watts	BTU	Element Output	Element Type	Code	£ Ex VAT	£ Inc VAT
800 x 400mm	263	897	150W	A, A+, D, E, F, G	89.0587	118.00	<b>141.60</b>
800 x 500mm	316	1078	150W	A, A+, D, E, F, G	89.0588	131.00	<b>157.20</b>
800 x 600mm	370	1262	150W	A, A+, D, E, F, G	89.0589	143.00	<b>171.60</b>

#### Westward - Straight Chrome 1200mm Height

Size H x W	Watts	BTU	Element Output	Element Type	Code	£ Ex VAT	£ Inc VAT
1200 x 400mm	375	1280	150W	A, A+, D, E, F, G	89.0590	158.00	<b>189.60</b>
1200 x 500mm	450	1535	150W	A, A+, D, E, F, G	89.0591	180.00	<b>216.00</b>
1200 x 600mm	524	1788	300W	A, A+, D, E, F, G	89.0592	195.00	<b>234.00</b>

#### Westward - Straight Chrome 1800mm Height

Size H x W	Watts	BTU	Element Output	Element Type	Code	£ Ex VAT	£ Inc VAT
1800 x 400mm	564	1924	300W	A, A+, D, E, F, G	89.0593	237.00	<b>284.40</b>
1800 x 500mm	677	2310	300W	A, A+, D, E, F, G	89.0594	259.00	<b>310.80</b>
1800 x 600mm	788	2689	450W	A, A+, D, E, F, G	89.0595	280.00	<b>336.00</b>

### Technical Tables & Drawings

Page 322-323



### Radiator Valves

Page 301-309



### TECHNICAL INFORMATION

All measurements in Height by Width. Heat output based on  $\Delta T60^{\circ}C$ . Radiators that are electric only are restricted to the heat output of the elements. Element size can be increased to full capacity of rail if using element type D, E, F or G. (Type F & G Elements suitable for all electric only) For element types see pages 288-300. For matching valves see pages 301-309. For indirect heating systems only. Tappings are approx. 44mm less than the width of the rail and approx. 65mm off the wall. Price includes radiator and wall fixing sets, valves extra.

#### 600mm High



#### 800mm High



#### 1200mm High



#### 1800mm High



# Multirail Range

## RION MULTIRAIL



Pictured 89.1691 Chrome

Rear fixing metal wall brackets

### Bar Dimensions (mm)

Horizontal Bars 20 x 20mm  
Vertical Bars D Shape 40 x 30mm



Pictured 89.1677 Matt Anthracite

Technical Tables  
& Drawings  
Page 322-323



D Shaped vertical bars meet square 20x20mm horizontal bars in this modern and elegant designed towel rail. Available in 3 heights and 2 widths with 4 colour options.

### FEATURES

- 40x30mm D shape vertical bars with 20x20mm square horizontal bars
  - Rear fixing metal wall brackets
  - Tested to BS EN 442 standards
  - 4 colours available from stock
  - 5 Year Manufacturer's Warranty\*
- \*With conditions



### Round Vent Caps

Page 313



# Multirail Range

## RION MULTIRAIL

Rion Multirail - Gloss White							
Size H x W	Watts	BTU	Element Output	Element Type	Code	£ Ex VAT	£ Inc VAT
800 x 500mm	419	1430	150W	A, A+, D, E, F, G	89.1671	135.00	<b>162.00</b>
800 x 600mm	478	1631	150W	A, A+, D, E, F, G	89.1672	153.00	<b>183.60</b>
1200 x 500mm	649	2215	150W	A, A+, D, E, F, G	89.1673	224.00	<b>268.80</b>
1200 x 600mm	740	2525	300W	A, A+, D, E, F, G	89.1674	245.00	<b>294.00</b>
1800 x 500mm	985	3361	300W	A, A+, D, E, F, G	89.1675	315.00	<b>378.00</b>
1800 x 600mm	1122	3829	300W	A, A+, D, E, F, G	89.1676	347.00	<b>416.40</b>

Rion Multirail - Matt Black							
Size H x W	Watts	BTU	Element Output	Element Type	Code	£ Ex VAT	£ Inc VAT
800 x 500mm	419	1430	150W	A, A+, D, E, F, G	89.1683	135.00	<b>162.00</b>
800 x 600mm	478	1631	150W	A, A+, D, E, F, G	89.1684	153.00	<b>183.60</b>
1200 x 500mm	649	2215	150W	A, A+, D, E, F, G	89.1685	224.00	<b>268.80</b>
1200 x 600mm	740	2525	300W	A, A+, D, E, F, G	89.1686	245.00	<b>294.00</b>
1800 x 500mm	985	3361	300W	A, A+, D, E, F, G	89.1687	315.00	<b>378.00</b>
1800 x 600mm	1122	3829	300W	A, A+, D, E, F, G	89.1688	347.00	<b>416.40</b>

Rion Multirail - Matt Anthracite							
Size H x W	Watts	BTU	Element Output	Element Type	Code	£ Ex VAT	£ Inc VAT
800 x 500mm	419	1430	150W	A, A+, D, E, F, G	89.1677	135.00	<b>162.00</b>
800 x 600mm	478	1631	150W	A, A+, D, E, F, G	89.1678	153.00	<b>183.60</b>
1200 x 500mm	649	2215	150W	A, A+, D, E, F, G	89.1679	224.00	<b>268.80</b>
1200 x 600mm	740	2525	300W	A, A+, D, E, F, G	89.1680	245.00	<b>294.00</b>
1800 x 500mm	985	3361	300W	A, A+, D, E, F, G	89.1681	315.00	<b>378.00</b>
1800 x 600mm	1122	3829	300W	A, A+, D, E, F, G	89.1682	347.00	<b>416.40</b>

Rion Multirail - Chrome							
Size H x W	Watts	BTU	Element Output	Element Type	Code	£ Ex VAT	£ Inc VAT
800 x 500mm	269	918	100W	A, A+, D, E, F, G	89.1689	197.00	<b>236.40</b>
800 x 600mm	304	1038	100W	A, A+, D, E, F, G	89.1690	223.00	<b>267.60</b>
1200 x 500mm	420	1434	150W	A, A+, D, E, F, G	89.1691	329.00	<b>394.80</b>
1200 x 600mm	475	1621	150W	A, A+, D, E, F, G	89.1692	359.00	<b>430.80</b>
1800 x 500mm	653	2229	150W	A, A+, D, E, F, G	89.1693	462.00	<b>554.40</b>
1800 x 600mm	738	2519	300W	A, A+, D, E, F, G	89.1694	509.00	<b>610.80</b>

### TECHNICAL INFORMATION

All measurements in Height by Width. Heat output based on  $\Delta T60^{\circ}C$ . Radiators that are electric only are restricted to the heat output of the elements. Element size can be increased to full capacity of rail if using element type D, E, F or G. (Type F & G Elements suitable for all electric only) For element types see pages 288-300. For matching valves see pages 301-309. For indirect heating systems only. Tappings are approx. 45mm less than the width of the rail and approx. 80mm off the wall. Price includes radiator and wall fixing sets, valves extra.



Warranty

**5**

Year

Heating

All Electric

Dual-Fuel

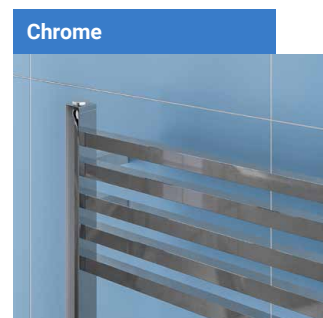

# Multirail Range

## TUSCAN - GLOSS WHITE / CHROME



Pictured 41.0317 Gloss White



Pictured 41.0309 Chrome

Warranty

5

Year

Diameter (Ø)

22

MM Bars

Heating

All Electric

Dual-Fuel

A simple design straight ladder rail which is the ideal combination of modern style and practicality. The range includes chrome and gloss white options in a range of sizes.

### FEATURES

- 22mm diameter horizontal round tubes
- Rear fixing wall brackets
- Tested to BS EN 442 standards
- 5 Year manufacturer's warranty\*
- Can be single or dual fuel, or all electric
- \* With conditions

### Technical Tables & Drawings

Page 320-321



### Round Vent Caps

Page 313



### Room Divider Bracket Sets

Page 311



### TECHNICAL INFORMATION

All measurements in Height by Width. Heat output based on  $\Delta T60^{\circ}C$ . Radiators that are electric only are restricted to the heat output of the elements. Element size can be increased to full capacity of rail if using element type D, E, F or G. (Type F & G Elements suitable for all electric only) For element types see pages 288-300. For matching valves see pages 301-309. For indirect heating systems only. Tappings are approx. 50mm less than the width of the rail and approx. 75mm off the wall. Price includes radiator and wall fixing sets, valves extra.

Tuscan - Gloss White							
Size H x W	Watts	BTU	Element Output	Element Type	Code	£ Ex VAT	£ Inc VAT
650 x 450mm	180	614	100W	A, A+, D, E, F, G	41.0314	63.00	<b>75.60</b>
650 x 600mm	212	723	100W	A, A+, D, E, F, G	41.0315	70.00	<b>84.00</b>
1200 x 450mm	315	1075	150W	A, A+, D, E, F, G	41.0316	84.00	<b>100.80</b>
1200 x 600mm	365	1245	150W	A, A+, D, E, F, G	41.0317	90.00	<b>108.00</b>
1750 x 450mm	464	1583	150W	A, A+, D, E, F, G	41.0318	109.00	<b>130.80</b>
1750 x 600mm	537	1832	300W	A, A+, D, E, F, G	41.0319	113.00	<b>135.60</b>

Tuscan - Chrome							
Size H x W	Watts	BTU	Element Output	Element Type	Code	£ Ex VAT	£ Inc VAT
650 x 450mm	142	485	100W	A, A+, D, E, F, G	41.0308	89.00	<b>106.80</b>
650 x 600mm	166	566	100W	A, A+, D, E, F, G	41.0309	97.00	<b>116.40</b>
1200 x 450mm	247	843	150W	A, A+, D, E, F, G	41.0310	137.00	<b>164.40</b>
1200 x 600mm	286	976	150W	A, A+, D, E, F, G	41.0311	149.00	<b>178.80</b>
1750 x 450mm	366	1249	150W	A, A+, D, E, F, G	41.0312	187.00	<b>224.40</b>
1750 x 600mm	423	1443	150W	A, A+, D, E, F, G	41.0313	202.00	<b>242.40</b>

# Multirail Range

## BIAVA ROUND



Pictured 41.0159 Gloss White



Pictured 41.0152 Chrome

Rear fixing wall brackets

A high quality modern, straight towel rail with a durable shiny chrome finish and round rails. A functional radiator with spacing to allow the warming of many towels yet with style that is aesthetically pleasing and will fit into any bathroom.

### Biava Round - Gloss White

Size H x W	Watts	BTU	Element Output	Element Type	Code	£ Ex VAT	£ Inc VAT
600 x 400mm	218	744	100W	A, A+, D, E, F, G	41.0154	91.00	109.20
600 x 500mm	257	877	150W	A, A+, D, E, F, G	41.0157	96.00	115.20
600 x 600mm	296	1010	150W	A, A+, D, E, F, G	41.0160	100.00	120.00
1200 x 400mm	412	1406	150W	A, A+, D, E, F, G	41.0155	137.00	164.40
1200 x 500mm	482	1645	300W	A, A+, D, E, F, G	41.0158	149.00	178.80
1200 x 600mm	552	1883	300W	A, A+, D, E, F, G	41.0161	156.00	187.20
1800 x 400mm	618	2109	300W	A, A+, D, E, F, G	41.0156	187.00	224.40
1800 x 500mm	723	2467	450W	A, A+, D, E, F, G	41.0159	202.00	242.40
1800 x 600mm	827	2822	450W	A, A+, D, E, F, G	41.0162	215.00	258.00

### Biava Round - Chrome

Size H x W	Watts	BTU	Element Output	Element Type	Code	£ Ex VAT	£ Inc VAT
600 x 400mm	172	587	100W	A, A+, D, E, F, G	41.0145	155.00	186.00
600 x 500mm	202	689	100W	A, A+, D, E, F, G	41.0148	161.00	193.20
600 x 600mm	234	798	150W	A, A+, D, E, F, G	41.0151	174.00	208.80
1200 x 400mm	324	1105	150W	A, A+, D, E, F, G	41.0146	247.00	296.40
1200 x 500mm	379	1293	150W	A, A+, D, E, F, G	41.0149	264.00	316.80
1200 x 600mm	435	1484	150W	A, A+, D, E, F, G	41.0152	284.00	340.80
1800 x 400mm	486	1658	300W	A, A+, D, E, F, G	41.0147	345.00	414.00
1800 x 500mm	569	1941	300W	A, A+, D, E, F, G	41.0150	372.00	446.40
1800 x 600mm	651	2221	300W	A, A+, D, E, F, G	41.0153	416.00	499.20

### FEATURES

- 19mm diameter horizontal round tubes
  - 38mm diameter vertical profiles
  - Rear fixing wall brackets
  - Tested to BS EN 442 standards
  - 5 Year Manufacturer's Warranty\*
- \* With conditions

Technical Tables & Drawings  
Page 324-325



### TECHNICAL INFORMATION

All measurements in Height by Width. Heat output based on  $\Delta T60^{\circ}C$ . Radiators that are electric only are restricted to the heat output of the elements. Element size can be increased to full capacity of rail if using element type D, E, F or G. (Type F & G Elements suitable for all electric only) For element types see pages 288-300. For matching valves see pages 301-309. For indirect heating systems only. Tappings are approx. 40mm less than the width of the rail and approx. 63mm off the wall. Price includes radiator and wall fixing sets, valves extra.

Warranty

5

Year

Diameter (Ø)

19

MM Bars

Heating

All Electric

Dual-Fuel

**Radiator Valves**  
Page 301-309

# Multirail Range

## CORINIUM ROUND

Warranty  
**5**  
Year

Diameter (Ø)  
**22**  
MM Bars

Heating  

All Electric  

Dual-Fuel  





Pictured 89.1571 Chrome

Rear fixing metal wall brackets



Pictured 89.1556 Matt Anthracite

**Technical Tables  
& Drawings**  
Page 322-323



A brand new edition to the Eastbrook Multirail Range. Available in a variety of colours to suit any bathroom. The generous spacing between the horizontal tubes allows for maximum towel drying.

### FEATURES

- 22mm diameter horizontal round tubes
  - 42mm diameter vertical profiles
  - Rear fixing metal wall brackets
  - Tested to BS EN 442 standards
  - 5 colours available from stock
  - State-of-the-Art welding technology
  - 5 Year Manufacturer's Warranty\*
- \* With conditions



**Round Vent Caps**  
Page 313



# Multirail Range

## CORINIUM ROUND

### Corinium Round - Gloss White

Size H x W	Watts	BTU	Element Output	Element Type	Code	£ Ex VAT	£ Inc VAT
800 x 500mm	392	1338	150W	A, A+, D, E, F, G	89.1542	119.00	<b>142.80</b>
800 x 600mm	458	1563	150W	A, A+, D, E, F, G	89.1543	137.00	<b>164.40</b>
1200 x 500mm	596	2034	150W	A, A+, D, E, F, G	89.1544	154.00	<b>184.80</b>
1200 x 600mm	696	2375	150W	A, A+, D, E, F, G	89.1545	178.00	<b>213.60</b>
1800 x 500mm	906	3092	300W	A, A+, D, E, F, G	89.1546	212.00	<b>254.40</b>
1800 x 600mm	1058	3610	300W	A, A+, D, E, F, G	89.1547	246.00	<b>295.20</b>

### Corinium Round - Matt Anthracite

Size H x W	Watts	BTU	Element Output	Element Type	Code	£ Ex VAT	£ Inc VAT
800 x 500mm	392	1338	150W	A, A+, D, E, F, G	89.1554	119.00	<b>142.80</b>
800 x 600mm	458	1563	150W	A, A+, D, E, F, G	89.1555	137.00	<b>164.40</b>
1200 x 500mm	596	2034	150W	A, A+, D, E, F, G	89.1556	154.00	<b>184.80</b>
1200 x 600mm	696	2375	150W	A, A+, D, E, F, G	89.1557	178.00	<b>213.60</b>
1800 x 500mm	906	3092	300W	A, A+, D, E, F, G	89.1558	212.00	<b>254.40</b>
1800 x 600mm	1058	3610	300W	A, A+, D, E, F, G	89.1559	246.00	<b>295.20</b>

### Corinium Round - Matt Grey

Size H x W	Watts	BTU	Element Output	Element Type	Code	£ Ex VAT	£ Inc VAT
800 x 500mm	392	1338	150W	A, A+, D, E, F, G	89.1548	119.00	<b>142.80</b>
800 x 600mm	458	1563	150W	A, A+, D, E, F, G	89.1549	137.00	<b>164.40</b>
1200 x 500mm	596	2034	150W	A, A+, D, E, F, G	89.1550	154.00	<b>184.80</b>
1200 x 600mm	696	2375	150W	A, A+, D, E, F, G	89.1551	178.00	<b>213.60</b>
1800 x 500mm	906	3092	300W	A, A+, D, E, F, G	89.1552	212.00	<b>254.40</b>
1800 x 600mm	1058	3610	300W	A, A+, D, E, F, G	89.1553	246.00	<b>295.20</b>

### Corinium Round - Matt Black

Size H x W	Watts	BTU	Element Output	Element Type	Code	£ Ex VAT	£ Inc VAT
800 x 500mm	392	1338	150W	A, A+, D, E, F, G	89.1560	119.00	<b>142.80</b>
800 x 600mm	458	1563	150W	A, A+, D, E, F, G	89.1561	137.00	<b>164.40</b>
1200 x 500mm	596	2034	150W	A, A+, D, E, F, G	89.1562	154.00	<b>184.80</b>
1200 x 600mm	696	2375	150W	A, A+, D, E, F, G	89.1563	178.00	<b>213.60</b>
1800 x 500mm	906	3092	300W	A, A+, D, E, F, G	89.1564	212.00	<b>254.40</b>
1800 x 600mm	1058	3610	300W	A, A+, D, E, F, G	89.1565	246.00	<b>295.20</b>

### Corinium Round - Chrome

Size H x W	Watts	BTU	Element Output	Element Type	Code	£ Ex VAT	£ Inc VAT
800 x 500mm	261	891	100W	A, A+, D, E, F, G	89.1566	180.00	<b>216.00</b>
800 x 600mm	305	1041	100W	A, A+, D, E, F, G	89.1567	207.00	<b>248.40</b>
1200 x 500mm	396	1352	150W	A, A+, D, E, F, G	89.1568	255.00	<b>306.00</b>
1200 x 600mm	462	1577	150W	A, A+, D, E, F, G	89.1569	296.00	<b>355.20</b>
1800 x 500mm	606	2068	300W	A, A+, D, E, F, G	89.1570	340.00	<b>408.00</b>
1800 x 600mm	707	2413	300W	A, A+, D, E, F, G	89.1571	395.00	<b>474.00</b>

### Radiator Valves

Page 301-309



### TECHNICAL INFORMATION

All measurements in Height by Width. Heat output based on  $\Delta T60^{\circ}C$ . Radiators that are electric only are restricted to the heat output of the elements. Element size can be increased to full capacity of rail if using element type D, E, F or G. (Type F & G Elements suitable for all electric only) For element types see pages 288-300. For matching valves see pages 301-309. For indirect heating systems only. Tappings are approx. 42mm less than the width of the rail and approx. 85mm off the wall. Price includes radiator and wall fixing sets, valves extra.



# Multirail Range

## TUSCAN ROUND

Warranty  
**5**  
Year

Diameter (∅)  
**22**  
MM Bars

Heating  

All Electric  

Dual-Fuel  





Pictured 89.1601 Chrome

Rear fixing metal wall brackets



Pictured 89.1574 Gloss White

**Technical Tables & Drawings**  
Page 322-323  

A popular addition to the Multirail Range. Available in a variety of colours to suit any bathroom. The generous spacing between the horizontal tubes allows for maximum towel drying.

### FEATURES

- 22mm diameter horizontal round tubes
- 42mm diameter vertical profiles
- Rear fixing metal wall brackets
- Tested to BS EN 442 standards
- 5 colours available from stock
- State-of-the-Art welding technology
- 5 Year Manufacturer's Warranty\*
- \* With conditions



### Round Vent Caps

Page 313





# Multirail Range

## TUSCAN ROUND

### Tuscan Round - Gloss White

Size H x W	Watts	BTU	Element Output	Element Type	Code	£ Ex VAT	£ Inc VAT
800 x 500mm	306	1045	100W	A, A+, D, E, F, G	89.1572	112.00	<b>134.40</b>
800 x 600mm	352	1202	100W	A, A+, D, E, F, G	89.1573	131.00	<b>157.20</b>
1200 x 500mm	459	1567	150W	A, A+, D, E, F, G	89.1574	144.00	<b>172.80</b>
1200 x 600mm	529	1805	150W	A, A+, D, E, F, G	89.1575	167.00	<b>200.40</b>
1800 x 500mm	688	2348	150W	A, A+, D, E, F, G	89.1576	200.00	<b>240.00</b>
1800 x 600mm	794	2710	300W	A, A+, D, E, F, G	89.1577	230.00	<b>276.00</b>

### Tuscan Round - Matt Anthracite

Size H x W	Watts	BTU	Element Output	Element Type	Code	£ Ex VAT	£ Inc VAT
800 x 500mm	306	1045	100W	A, A+, D, E, F, G	89.1584	112.00	<b>134.40</b>
800 x 600mm	352	1202	100W	A, A+, D, E, F, G	89.1585	131.00	<b>157.20</b>
1200 x 500mm	459	1567	150W	A, A+, D, E, F, G	89.1586	144.00	<b>172.80</b>
1200 x 600mm	529	1805	150W	A, A+, D, E, F, G	89.1587	167.00	<b>200.40</b>
1800 x 500mm	688	2348	150W	A, A+, D, E, F, G	89.1588	200.00	<b>240.00</b>
1800 x 600mm	794	2710	300W	A, A+, D, E, F, G	89.1589	230.00	<b>276.00</b>

### Tuscan Round - Matt Grey

Size H x W	Watts	BTU	Element Output	Element Type	Code	£ Ex VAT	£ Inc VAT
800 x 500mm	306	1045	100W	A, A+, D, E, F, G	89.1578	112.00	<b>134.40</b>
800 x 600mm	352	1202	100W	A, A+, D, E, F, G	89.1579	131.00	<b>157.20</b>
1200 x 500mm	459	1567	150W	A, A+, D, E, F, G	89.1580	144.00	<b>172.80</b>
1200 x 600mm	529	1805	150W	A, A+, D, E, F, G	89.1581	167.00	<b>200.40</b>
1800 x 500mm	688	2348	150W	A, A+, D, E, F, G	89.1582	200.00	<b>240.00</b>
1800 x 600mm	794	2710	300W	A, A+, D, E, F, G	89.1583	230.00	<b>276.00</b>

### Tuscan Round - Matt Black

Size H x W	Watts	BTU	Element Output	Element Type	Code	£ Ex VAT	£ Inc VAT
800 x 500mm	306	1045	100W	A, A+, D, E, F, G	89.1590	112.00	<b>134.40</b>
800 x 600mm	352	1202	100W	A, A+, D, E, F, G	89.1591	131.00	<b>157.20</b>
1200 x 500mm	459	1567	150W	A, A+, D, E, F, G	89.1592	144.00	<b>172.80</b>
1200 x 600mm	529	1805	150W	A, A+, D, E, F, G	89.1593	167.00	<b>200.40</b>
1800 x 500mm	688	2348	150W	A, A+, D, E, F, G	89.1594	200.00	<b>240.00</b>
1800 x 600mm	794	2710	300W	A, A+, D, E, F, G	89.1595	230.00	<b>276.00</b>

### Tuscan Round - Chrome

Size H x W	Watts	BTU	Element Output	Element Type	Code	£ Ex VAT	£ Inc VAT
800 x 500mm	201	686	100W	A, A+, D, E, F, G	89.1596	165.00	<b>198.00</b>
800 x 600mm	232	792	100W	A, A+, D, E, F, G	89.1597	191.00	<b>229.20</b>
1200 x 500mm	303	1034	100W	A, A+, D, E, F, G	89.1598	239.00	<b>286.80</b>
1200 x 600mm	350	1195	100W	A, A+, D, E, F, G	89.1599	278.00	<b>333.60</b>
1800 x 500mm	454	1550	150W	A, A+, D, E, F, G	89.1600	320.00	<b>384.00</b>
1800 x 600mm	525	1792	150W	A, A+, D, E, F, G	89.1601	370.00	<b>444.00</b>

### Radiator Valves

Page 301-309



### TECHNICAL INFORMATION

All measurements in Height by Width. Heat output based on  $\Delta T60^{\circ}\text{C}$ . Radiators that are electric only are restricted to the heat output of the elements. Element size can be increased to full capacity of rail if using element type D, E, F or G. (Type F & G Elements suitable for all electric only) For element types see pages 288-300. For matching valves see pages 301-309. For indirect heating systems only. Tappings are approx. 42mm less than the width of the rail and approx. 85mm off the wall. Price includes radiator and wall fixing sets, valves extra.



# Multirail Range

## BIAVA - TUBE ON TUBE, CHROME



Pictured 41.0171 Chrome

**Round Vent Caps**  
Page 313

**Multi-Rail Hangers**  
Page 310

**Technical Tables & Drawings**  
Page 324-325

A contemporary tubular design towel rail in a range of sizes and both chrome and white finishes. The tube on tube features produces a higher heat output.

**FEATURES**

- 19mm diameter horizontal round tubes
  - 32mm diameter vertical profiles
  - Tested to BS EN 442 standards
  - 5 Year Manufacturer's Warranty\*
- \* With conditions

Warranty

**5**

Year

Diameter (Ø)

**19**

MM Bars

Heating

All Electric

Dual-Fuel

**Radiator Valves**  
Page 301-309



**Biava - Tube on Tube - Chrome**

Size H x W	Watts	BTU	Element Output	Element Type	Code	£ Ex VAT	£ Inc VAT
600 x 400mm	183	624	100W	A, A+, D, E, F, G	41.0163	174.00	<b>208.80</b>
600 x 500mm	214	730	100W	A, A+, D, E, F, G	41.0166	182.00	<b>218.40</b>
600 x 600mm	245	836	150W	A, A+, D, E, F, G	41.0169	192.00	<b>230.40</b>
1200 x 400mm	428	1460	150W	A, A+, D, E, F, G	41.0164	314.00	<b>376.80</b>
1200 x 500mm	505	1723	300W	A, A+, D, E, F, G	41.0167	345.00	<b>414.00</b>
1200 x 600mm	580	1979	300W	A, A+, D, E, F, G	41.0170	369.00	<b>442.80</b>
1800 x 400mm	661	2255	300W	A, A+, D, E, F, G	41.0165	460.00	<b>552.00</b>
1800 x 500mm	780	2661	450W	A, A+, D, E, F, G	41.0168	500.00	<b>600.00</b>
1800 x 600mm	898	3064	450W	A, A+, D, E, F, G	41.0171	542.00	<b>650.40</b>

**TECHNICAL INFORMATION**

All measurements in Height by Width. Heat output based on ▲T60°C. Radiators that are electric only are restricted to the heat output of the elements. Element size can be increased to full capacity of rail if using element type D, E, F or G. (Type F & G Elements suitable for all electric only) For element types see pages 288-300. For matching valves see pages 301-309. For indirect heating systems only. Tappings are approx. 50mm less than the width of the rail and approx. 55mm off the wall. Price includes radiator and wall fixing sets, valves extra.

**Robe Hooks**  
Page 310

**Towel Hangers**  
Page 310

# Multirail Range

## BIAVA SQUARE - CHROME



**Technical Tables & Drawings**  
Page 326-327



**Bar Dimensions (mm)**  
Horizontal Bars 22 x 22mm  
Vertical Bars 40 x 40mm

**Round Vent Caps**  
Page 313



Pictured 41.0116 Chrome

A modern style square rail that still allows maximum space for keeping your towels warm.

Biava Square - Chrome							
Size H x W	Watts	BTU	Element Output	Element Type	Code	£ Ex VAT	£ Inc VAT
600 x 400mm	221	754	100W	A, A+, D, E, F, G	41.0109	239.00	<b>286.80</b>
600 x 500mm	260	887	150W	A, A+, D, E, F, G	41.0112	259.00	<b>310.80</b>
600 x 600mm	299	1020	150W	A, A+, D, E, F, G	41.0115	280.00	<b>336.00</b>
1200 x 400mm	511	1744	300W	A, A+, D, E, F, G	41.0110	455.00	<b>546.00</b>
1200 x 500mm	612	2088	300W	A, A+, D, E, F, G	41.0113	516.00	<b>619.20</b>
1200 x 600mm	712	2429	300W	A, A+, D, E, F, G	41.0116	555.00	<b>666.00</b>
1800 x 400mm	746	2545	450W	A, A+, D, E, F, G	41.0111	636.00	<b>763.20</b>
1800 x 500mm	889	3033	450W	A, A+, D, E, F, G	41.0114	711.00	<b>853.20</b>
1800 x 600mm	1034	3528	600W	A, A+, D, E, F, G	41.0117	783.00	<b>939.60</b>

- FEATURES**
- Tested to BS EN 442 standards
  - 5 Year manufacturer's warranty\*
  - Can be single or dual fuel, or all electric
- \* With conditions

Warranty

**5**

Year

Heating



All Electric



Dual-Fuel



### TECHNICAL INFORMATION

All measurements in Height by Width. Heat output based on  $\Delta T60^{\circ}\text{C}$ . Radiators that are electric only are restricted to the heat output of the elements. Element size can be increased to full capacity of rail if using element type D, E, F or G. (Type F & G Elements suitable for all electric only) For element types see pages 288-300. For matching valves see pages 301-309. For indirect heating systems only. Tappings are approx. 40mm less than the width of the rail and approx. 70mm off the wall. Price includes radiator and wall fixing sets, valves extra.

### COMPLETE THE LOOK

Radiator Valves  
Page: 301-309



# Multirail Range

## TUSCAN SQUARE MULTIRAIL



Pictured 89.1667 Chrome



Pictured 89.1648 Gloss White

**Technical Tables & Drawings**  
Page 326-327



**Bar Dimensions (mm)**  
Horizontal Bars 20 x 20mm  
Vertical Bars 30 x 30mm

Rear fixing metal wall brackets

The very popular Tuscan Square towel rail is now available as Multirail. Available in 3 heights and 2 widths with 4 colour options.

**FEATURES**

- 30x30mm square vertical bars with 20x20mm square horizontal bars
  - Rear fixing metal wall brackets
  - Tested to BS EN 442 standards
  - 4 colours available from stock
  - 5 Year Manufacturer's Warranty\*
- \*With conditions



**Round Vent Caps**  
Page 313



# Multirail Range

## TUSCAN SQUARE MULTIRAIL

Tuscan Square Multirail - Gloss White							
Size H x W	Watts	BTU	Element Output	Element Type	Code	£ Ex VAT	£ Inc VAT
800 x 500mm	425	1451	150W	A, A+, D, E, F, G	89.1647	135.00	<b>162.00</b>
800 x 600mm	497	1696	150W	A, A+, D, E, F, G	89.1648	153.00	<b>183.60</b>
1200 x 500mm	662	2259	150W	A, A+, D, E, F, G	89.1649	224.00	<b>268.80</b>
1200 x 600mm	775	2645	300W	A, A+, D, E, F, G	89.1650	245.00	<b>294.00</b>
1800 x 500mm	980	3344	300W	A, A+, D, E, F, G	89.1651	315.00	<b>378.00</b>
1800 x 600mm	1147	3914	300W	A, A+, D, E, F, G	89.1652	347.00	<b>416.40</b>

Tuscan Square Multirail - Matt Black							
Size H x W	Watts	BTU	Element Output	Element Type	Code	£ Ex VAT	£ Inc VAT
800 x 500mm	425	1451	150W	A, A+, D, E, F, G	89.1659	135.00	<b>162.00</b>
800 x 600mm	497	1696	150W	A, A+, D, E, F, G	89.1660	153.00	<b>183.60</b>
1200 x 500mm	662	2259	150W	A, A+, D, E, F, G	89.1661	224.00	<b>268.80</b>
1200 x 600mm	775	2645	300W	A, A+, D, E, F, G	89.1662	245.00	<b>294.00</b>
1800 x 500mm	980	3344	300W	A, A+, D, E, F, G	89.1663	315.00	<b>378.00</b>
1800 x 600mm	1147	3914	300W	A, A+, D, E, F, G	89.1664	347.00	<b>416.40</b>

Tuscan Square Multirail - Matt Anthracite							
Size H x W	Watts	BTU	Element Output	Element Type	Code	£ Ex VAT	£ Inc VAT
800 x 500mm	425	1451	150W	A, A+, D, E, F, G	89.1653	135.00	<b>162.00</b>
800 x 600mm	497	1696	150W	A, A+, D, E, F, G	89.1654	153.00	<b>183.60</b>
1200 x 500mm	662	2259	150W	A, A+, D, E, F, G	89.1655	224.00	<b>268.80</b>
1200 x 600mm	775	2645	300W	A, A+, D, E, F, G	89.1656	245.00	<b>294.00</b>
1800 x 500mm	980	3344	300W	A, A+, D, E, F, G	89.1657	315.00	<b>378.00</b>
1800 x 600mm	1147	3914	300W	A, A+, D, E, F, G	89.1658	347.00	<b>416.40</b>

Tuscan Square Multirail - Chrome							
Size H x W	Watts	BTU	Element Output	Element Type	Code	£ Ex VAT	£ Inc VAT
800 x 500mm	274	935	100W	A, A+, D, E, F, G	89.1665	197.00	<b>236.40</b>
800 x 600mm	316	1079	100W	A, A+, D, E, F, G	89.1666	223.00	<b>267.60</b>
1200 x 500mm	426	1454	150W	A, A+, D, E, F, G	89.1667	329.00	<b>394.80</b>
1200 x 600mm	491	1676	150W	A, A+, D, E, F, G	89.1668	359.00	<b>430.80</b>
1800 x 500mm	645	2201	150W	A, A+, D, E, F, G	89.1669	462.00	<b>554.40</b>
1800 x 600mm	744	2539	300W	A, A+, D, E, F, G	89.1670	509.00	<b>610.80</b>

### TECHNICAL INFORMATION

All measurements in Height by Width. Heat output based on  $\Delta T60^{\circ}C$ . Radiators that are electric only are restricted to the heat output of the elements. Element size can be increased to full capacity of rail if using element type D, E, F or G. (Type F & G Elements suitable for all electric only) For element types see pages 288-300. For matching valves see pages 301-309. For indirect heating systems only. Tappings are approx. 30mm less than the width of the rail and approx. 80mm off the wall. Price includes radiator and wall fixing sets, valves extra.



Warranty

**5**

Year

Heating

All Electric

Dual-Fuel

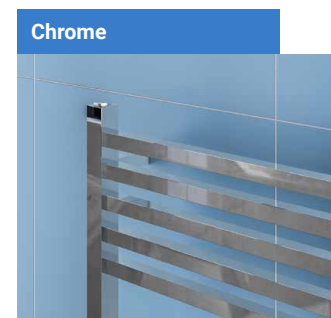
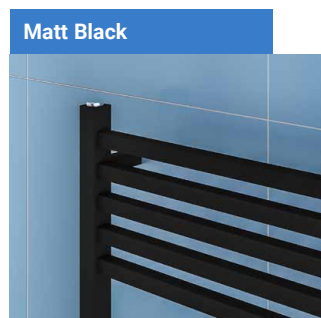

# Multirail Range

## TUSCAN SQUARE



**Technical Tables & Drawings**  
Page 326-327



Pictured 89.1270 Chrome

### Bar Dimensions (mm)

Horizontal Bars 20 x 20mm  
Vertical Bars 30 x 30mm

Evenly placed square bars of Tuscan Square is the new definition of minimalism.

Tuscan Square - Chrome							
Size H x W	Watts	BTU	Element Output	Element Type	Code	£ Ex VAT	£ Inc VAT
800 x 500mm	201	686	100W	A, A+, D, E, F, G	89.1268	159.00	<b>190.80</b>
800 x 600mm	231	789	100W	A, A+, D, E, F, G	89.1269	173.00	<b>207.60</b>
1200 x 500mm	302	1031	100W	A, A+, D, E, F, G	89.1270	208.00	<b>249.60</b>
1200 x 600mm	347	1184	150W	A, A+, D, E, F, G	89.1271	227.00	<b>272.40</b>
1800 x 500mm	458	1563	150W	A, A+, D, E, F, G	89.1272	297.00	<b>356.40</b>
1800 x 600mm	526	1795	150W	A, A+, D, E, F, G	89.1273	320.00	<b>384.00</b>

### FEATURES

- Tested to BS EN 442 standards
- Rear fixing metal wall brackets
- 5 Year manufacturer's warranty\*
- Can be single or dual fuel, or all electric
- \* With conditions



Pictured 89.1273 Chrome

Rear fixing metal wall brackets

### TECHNICAL INFORMATION

All measurements in Height by Width. Heat output based on  $\Delta T60^{\circ}C$ . Radiators that are electric only are restricted to the heat output of the elements. Element size can be increased to full capacity of rail if using element type D, E, F or G. (Type F & G Elements suitable for all electric only) For element types see pages 288-300. For matching valves see pages 301-309. For indirect heating systems only. Tappings are approx. 30mm less than the width of the rail and approx. 80mm off the wall. Projection from wall is approx. 95mm. Price includes radiator and wall fixing sets, valves extra.

Warranty

**5**  
Year

Heating

All Electric

Dual-Fuel

### Round Vent Caps

Page 313



### Radiator Valves

Page 301-309



# Multirail Range

## TUSCAN SQUARE

Gloss White

Pictured 89.1244 Gloss White

**Bar Dimensions (mm)**

Horizontal Bars 20 x 20mm  
Vertical Bars 30 x 30mm



Tuscan Square - Gloss White

Size H x W	Watts	BTU	Element Output	Element Type	Code	£ Ex VAT	£ Inc VAT
800 x 500mm	305	1041	100W	A, A+, D, E, F, G	89.1244	121.00	145.20
800 x 600mm	349	1191	150W	A, A+, D, E, F, G	89.1245	133.00	159.60
1200 x 500mm	460	1570	150W	A, A+, D, E, F, G	89.1246	155.00	186.00
1200 x 600mm	527	1799	150W	A, A+, D, E, F, G	89.1247	167.00	200.40
1800 x 500mm	688	2348	300W	A, A+, D, E, F, G	89.1248	208.00	249.60
1800 x 600mm	789	2693	300W	A, A+, D, E, F, G	89.1249	227.00	272.40

Matt Grey

Pictured 89.1253 Matt Grey

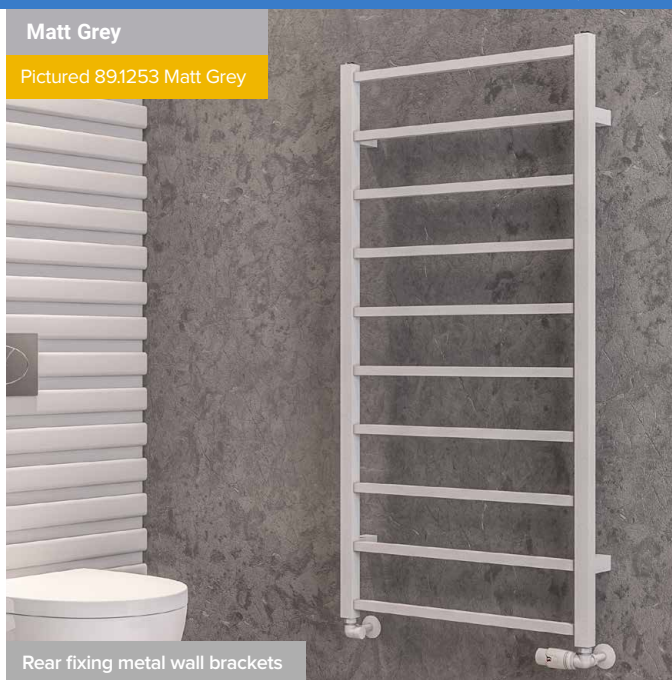

Rear fixing metal wall brackets

Tuscan Square - Matt Grey

Size H x W	Watts	BTU	Element Output	Element Type	Code	£ Ex VAT	£ Inc VAT
800 x 500mm	305	1041	100W	A, A+, D, E, F, G	89.1250	121.00	145.20
800 x 600mm	349	1191	150W	A, A+, D, E, F, G	89.1251	133.00	159.60
1200 x 500mm	460	1570	150W	A, A+, D, E, F, G	89.1252	155.00	186.00
1200 x 600mm	527	1799	150W	A, A+, D, E, F, G	89.1253	167.00	200.40
1800 x 500mm	688	2348	300W	A, A+, D, E, F, G	89.1254	208.00	249.60
1800 x 600mm	789	2693	300W	A, A+, D, E, F, G	89.1255	227.00	272.40

Matt Anthracite

Pictured 89.1257 Matt Anthracite

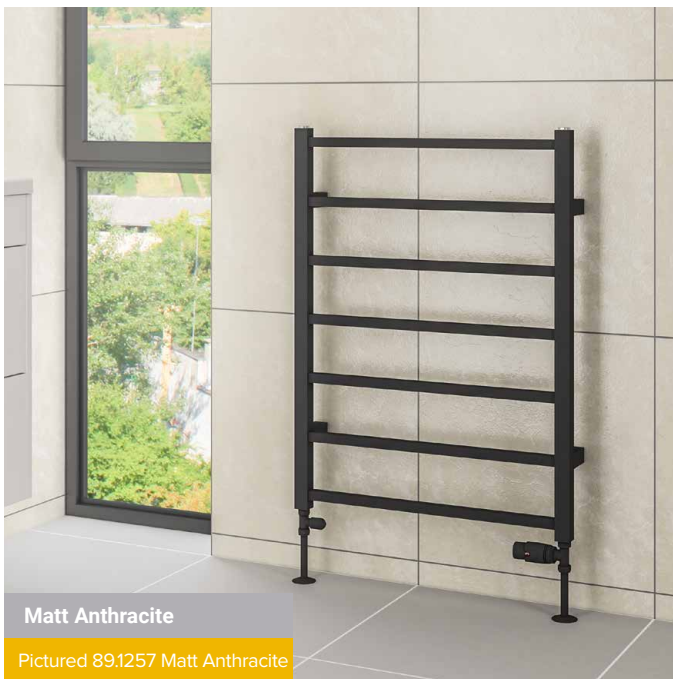

Tuscan Square - Matt Anthracite

Size H x W	Watts	BTU	Element Output	Element Type	Code	£ Ex VAT	£ Inc VAT
800 x 500mm	305	1041	100W	A, A+, D, E, F, G	89.1256	121.00	145.20
800 x 600mm	349	1191	150W	A, A+, D, E, F, G	89.1257	133.00	159.60
1200 x 500mm	460	1570	150W	A, A+, D, E, F, G	89.1258	155.00	186.00
1200 x 600mm	527	1799	150W	A, A+, D, E, F, G	89.1259	167.00	200.40
1800 x 500mm	688	2348	300W	A, A+, D, E, F, G	89.1260	208.00	249.60
1800 x 600mm	789	2693	300W	A, A+, D, E, F, G	89.1261	227.00	272.40

Matt Black

Pictured 89.1266 Matt Black

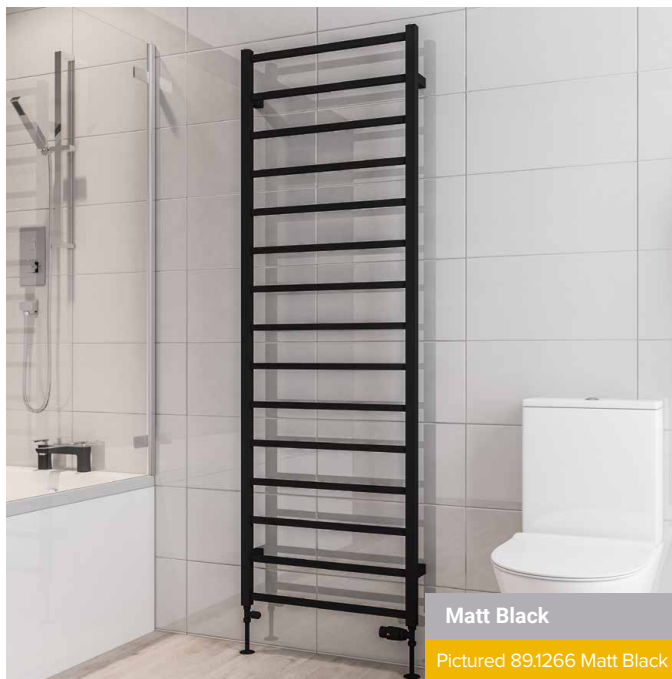

Tuscan Square - Matt Black

Size H x W	Watts	BTU	Element Output	Element Type	Code	£ Ex VAT	£ Inc VAT
800 x 500mm	305	1041	100W	A, A+, D, E, F, G	89.1262	121.00	145.20
800 x 600mm	349	1191	150W	A, A+, D, E, F, G	89.1263	133.00	159.60
1200 x 500mm	460	1570	150W	A, A+, D, E, F, G	89.1264	155.00	186.00
1200 x 600mm	527	1799	150W	A, A+, D, E, F, G	89.1265	167.00	200.40
1800 x 500mm	688	2348	300W	A, A+, D, E, F, G	89.1266	208.00	249.60
1800 x 600mm	789	2693	300W	A, A+, D, E, F, G	89.1267	227.00	272.40

# Multirail Range

## LAUNTON

Pictured 61.0067 Chrome

Heated Shelves 

Square Profiles 



Warranty

5

Year

Heating



All Electric



Dual-Fuel



Bar Dimensions (mm)

Horizontal Bars 20 x 20mm  
Vertical Bars 30 x 30mm



# Multirail Range

## LAUNTON

Launton towel radiator has built-in shelves that are also heated. This model will be the solution to dry all the towels of a big family.

### FEATURES

- Tested to BS EN 442 standards
- Built-in heated shelves
- Can be single, dual fuel or all electric
- 5 Year Manufacturer's Warranty\*
- \* With conditions



Pictured 61.0065 Matt Anthracite

### Launton - Matt White

Size H x W	Watts	BTU	Element Output	Element Type	Code	£ Ex VAT	£ Inc VAT
1200 x 500mm	439	1496	150W	A, A+, D, E, F, G	61.0062	359.00	<b>430.80</b>
1200 x 600mm	489	1670	300W	A, A+, D, E, F, G	61.0063	370.00	<b>444.00</b>

### Launton - Matt Anthracite

Size H x W	Watts	BTU	Element Output	Element Type	Code	£ Ex VAT	£ Inc VAT
1200 x 500mm	439	1496	150W	A, A+, D, E, F, G	61.0064	359.00	<b>430.80</b>
1200 x 600mm	489	1670	300W	A, A+, D, E, F, G	61.0065	370.00	<b>444.00</b>

### Launton - Chrome

Size H x W	Watts	BTU	Element Output	Element Type	Code	£ Ex VAT	£ Inc VAT
1200 x 500mm	290	991	150W	A, A+, D, E, F, G	61.0066	434.00	<b>520.80</b>
1200 x 600mm	324	1106	150W	A, A+, D, E, F, G	61.0067	450.00	<b>540.00</b>

### TECHNICAL INFORMATION

All measurements in Height by Width. Heat output based on  $\Delta T60^{\circ}C$ . Radiators that are electric only are restricted to the heat output of the elements. Element size can be increased to full capacity of rail if using element type D, E, F or G. (Type F & G Elements suitable for all electric only) For element types see pages 288-300. For matching valves see pages 301-309. For indirect heating systems only. Tappings are approx. 30mm less than the width of the rail and approx. 70-85mm off the wall. Projection from the wall is 255-270mm. Price includes radiator and wall fixing sets, valves extra.

### Radiator Valves

Page 301-309



### Matt White



Pictured 61.0063

### Matt Anthracite



Pictured 61.0065

### Chrome



Pictured 61.0067

### Round Vent Caps

Page 313



### Technical Tables & Drawings

Page 324-325

# Multirail Range

## HADDENHAM

Pictured 61.0073 Chrome

Heated Shelves 

D Shape Profiles 



Warranty  
**5**  
Year

Diameter (Ø)  
**22**  
MM Bars

Heating  

All Electric  

Dual-Fuel  

# Multirail Range

## HADDENHAM

Haddenham towel radiator is a perfect alternative for standard towel radiators thanks to its heated shelves and big capacity of drying many towels at once.

### FEATURES

- 22mm diameter horizontal round tubes
- Tested to BS EN 442 standards
- Built-in heated shelves
- Can be single, dual fuel or all electric
- 5 Year Manufacturer's Warranty\*
- \* With conditions



Pictured 61.0069 Matt White

### Haddenham - Matt White

Size H x W	Watts	BTU	Element Output	Element Type	Code	£ Ex VAT	£ Inc VAT
1200 x 500mm	645	2200	300W	A, A+, D, E, F, G	61.0068	257.00	<b>308.40</b>
1200 x 600mm	732	2499	450W	A, A+, D, E, F, G	61.0069	266.00	<b>319.20</b>

### Haddenham - Matt Anthracite

Size H x W	Watts	BTU	Element Output	Element Type	Code	£ Ex VAT	£ Inc VAT
1200 x 500mm	645	2200	300W	A, A+, D, E, F, G	61.0070	257.00	<b>308.40</b>
1200 x 600mm	732	2499	450W	A, A+, D, E, F, G	61.0071	266.00	<b>319.20</b>

### Haddenham - Chrome

Size H x W	Watts	BTU	Element Output	Element Type	Code	£ Ex VAT	£ Inc VAT
1200 x 500mm	427	1457	150W	A, A+, D, E, F, G	61.0072	312.00	<b>374.40</b>
1200 x 600mm	485	1655	300W	A, A+, D, E, F, G	61.0073	334.00	<b>400.80</b>

### TECHNICAL INFORMATION

All measurements in Height by Width. Heat output based on  $\Delta T60^{\circ}C$ . Radiators that are electric only are restricted to the heat output of the elements. Element size can be increased to full capacity of rail if using element type D, E, F or G. (Type F & G Elements suitable for all electric only) For element types see pages 288-300. For matching valves see pages 301-309. For indirect heating systems only. Tappings are approx. 45mm less than the width of the rail and approx. 70-85mm off the wall. Projection from the wall is approx. 255-270mm. Price includes radiator and wall fixing sets, valves extra.

### Robe Hooks

Page 310



### Round Vent Caps

Page 313



### Matt White



Pictured 61.0069

### Matt Anthracite



Pictured 61.0071

### Chrome



Pictured 61.0073

### Towel Hangers

Page 310



### Multi-Rail Hangers

Page 310



### Technical Tables & Drawings

Page 324-325





# Dry Element Range

Using modern technology benefits, the Dry Element Range consists of lighter towel rails and energy efficient daily usage.

## Contents

Derwent Aluminium Dry Element - Available in 3 colours - <b>NEW PRODUCT</b>	68-69
Biava Dry Element Straight, Available in 3 colours	70-71
Loddon Dry Element, Available in 4 colours	72-73
Kennet Dry Element, Matt Anthracite & Chrome	74
Emsbury Dry Element, Polished Stainless Steel	75



# Dry Element Range

## DERWENT ALUMINIUM DRY ELEMENT

Due in November 2023



Pictured 41.0491 Matt White with 41.0503 Towel Hangers

A dry element aluminium radiator with sharp lines in the front and chrome cover caps at the top and bottom that will add fashion to your desired room. With a choice of towel hangers, your bathroom can also be heated while drying your towels. Available in vertical style and 3 colours options.

### FEATURES

- No fluid filling required, just Connect and Go
- Comes with built-in thermostat, 35° C - 70°C temperature setting
- Comes with built-in timer, 2 - 8 hour setting
- Comes with concealed wiring
- IPX4 certificate (Zone 2 and 3)
- Radiators come with chrome cover caps on top and bottom
- Tested to BS EN 442 standards
- 2 Year Manufacturer's Warranty\*
- \* With conditions



Pictured 41.0494 Matt Anthracite

Technical Tables  
& Drawings  
Page 328-329



This product is electric only installation and cannot be used on a central heating system.

### TECHNICAL INFORMATION

All measurements in Height by Width. Heat output based on  $\Delta T60^{\circ}\text{C}$ . Cannot be fitted upside down.

Each vertical aluminium panel is 100mm wide.

Projection from wall is 115mm.

Radiator material is aluminium.

Towel Hanger material is Stainless Steel.

# Dry Element Range

## DERWENT ALUMINIUM DRY ELEMENT

Due in November 2023

### Derwent Dry Element Vertical Aluminium Radiators - Matt White

Size H x W	Watts	BTU	Code	£ Ex VAT	£ Inc VAT
1800 x 304mm	600	2047	41.0489	326.00	<b>391.20</b>
1800 x 404mm	800	2730	41.0490	402.00	<b>482.40</b>
1800 x 504mm	1000	3412	41.0491	476.00	<b>571.20</b>
1800 x 604mm	1200	4094	41.0492	533.00	<b>639.60</b>

### Derwent Dry Element Vertical Aluminium Radiators - Matt Anthracite

Size H x W	Watts	BTU	Code	£ Ex VAT	£ Inc VAT
1800 x 304mm	600	2047	41.0493	326.00	<b>391.20</b>
1800 x 404mm	800	2730	41.0494	402.00	<b>482.40</b>
1800 x 504mm	1000	3412	41.0495	476.00	<b>571.20</b>
1800 x 604mm	1200	4094	41.0496	533.00	<b>639.60</b>

### Derwent Dry Element Vertical Aluminium Radiators - Matt Black

Size H x W	Watts	BTU	Code	£ Ex VAT	£ Inc VAT
1800 x 304mm	600	2047	41.0497	326.00	<b>391.20</b>
1800 x 404mm	800	2730	41.0498	402.00	<b>482.40</b>
1800 x 504mm	1000	3412	41.0499	476.00	<b>571.20</b>
1800 x 604mm	1200	4094	41.0500	533.00	<b>639.60</b>

Prices include radiator and wall fixing sets, towel hangers are extra.





**THERMOSTAT FUNCTION**  
Comes with built-in thermostat  
35° C - 70° C temperature setting

**TIMING FUNCTION**  
Comes with built-in timer  
2 - 8 hour setting  
\* Not programmable

IPX4 certificate (Zone 2 and 3)

Warranty

2

Year

All Electric



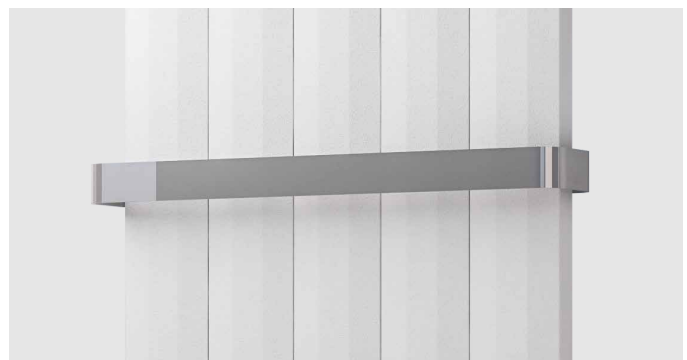
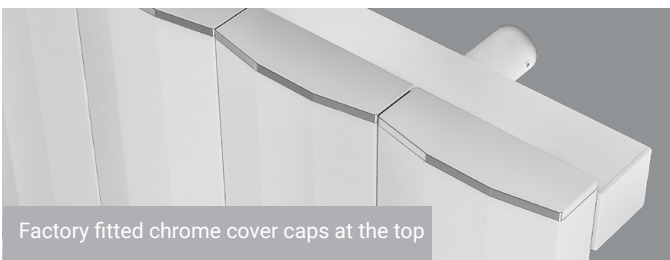

### Towel Hanger - Mirror Polished Premium

Description	Code	£ Ex VAT	£ Inc VAT
Towel Hanger 304mm	41.0501	54.00	<b>64.80</b>
Towel Hanger 404mm	41.0502	57.00	<b>68.40</b>
Towel Hanger 504mm	41.0503	66.00	<b>79.20</b>
Towel Hanger 604mm	41.0504	72.00	<b>86.40</b>

# Dry Element Range

## BIAVA DRY ELEMENT - STRAIGHT



**Technical Tables  
& Drawings**  
Page 326-327



Pictured 47.0001 Chrome with 67.0004 & 67.0005



Integrated On/Off Button



On/Off Button

Pictured 47.0015 Chrome

### Biava Dry Element Towel Rail - Chrome [Integrated On/Off Button]

Size H x W	Watts	BTU	Code	£ Ex VAT	£ Inc VAT
1100 x 500mm	400	1365	47.0015	297.00	<b>356.40</b>

### Biava Dry Element Towel Rail - Chrome

Size H x W	Watts	BTU	Code	£ Ex VAT	£ Inc VAT
700 x 500mm	250	853	47.0001	202.00	<b>242.40</b>
700 x 600mm	300	1024	47.0003	222.00	<b>266.40</b>
1100 x 500mm	400	1365	47.0002	268.00	<b>321.60</b>
1100 x 600mm	500	1706	47.0004	305.00	<b>366.00</b>

### Biava Dry Element Towel Rail - Gloss White

Size H x W	Watts	BTU	Code	£ Ex VAT	£ Inc VAT
700 x 500mm	250	853	47.0005	154.00	<b>184.80</b>
700 x 600mm	300	1024	47.0007	174.00	<b>208.80</b>
1100 x 500mm	400	1365	47.0006	210.00	<b>252.00</b>
1100 x 600mm	500	1706	47.0008	238.00	<b>285.60</b>

### Biava Dry Element Towel Rail - Matt Anthracite

Size H x W	Watts	BTU	Code	£ Ex VAT	£ Inc VAT
700 x 500mm	250	853	47.0009	171.00	<b>205.20</b>
700 x 600mm	300	1024	47.0011	191.00	<b>229.20</b>
1100 x 500mm	400	1365	47.0010	226.00	<b>271.20</b>
1100 x 600mm	500	1706	47.0012	262.00	<b>314.40</b>

### FEATURES

- 19mm diameter horizontal round tubes
  - No fluid filling required
  - Just Connect and Go
  - Material of towel rail: Mild Steel
  - IPX4 Certificates (Zone 2 and 3)
  - Compatible with the Crafton Temperature Control Plate
  - 2 Year Manufacturer's Warranty\*
- \* With conditions

This product is electric only installation and cannot be used on a central heating system.

### TECHNICAL INFORMATION

All measurements in Height by Width. Heat output based on ▲T60°C. This rail is reversible. Can not be fitted upside down.

Warranty

**2**  
Year

Diameter (Ø)

**19**  
MM Bars

All Electric





# Dry Element Range

## BIAVA DRY ELEMENT - STRAIGHT

Gloss White



Pictured 47.0007 Gloss White with 67.0004

Chrome



Pictured 47.0004 Chrome with 67.0004 & 67.0005

Matt Anthracite



Pictured 47.0012 Matt Anthracite with 67.0004 & 67.0005



Pictured 67.0004

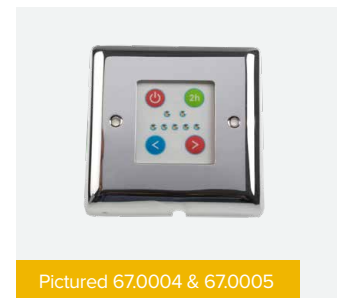

Pictured 67.0004 & 67.0005

### Optional Extra - Crafton Temperature Control Panel

Description	Code	£ Ex VAT	£ Inc VAT
Crafton Temperature Control Panel	67.0004	113.00	135.60
Chrome Plate for Crafton Temp Panel	67.0005	38.00	45.60

This item is an additional extra, that can be used with all above colours of the Biava Dry Element Towel Rails. Please see page 301 for more product details.

### Robe Hooks Page 850

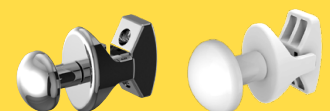

### Towel Hangers Page 310



### Multi-Rail Hangers Page 310



# Dry Element Range

## LODDON DRY ELEMENT



Pictured 47.0042 Chrome

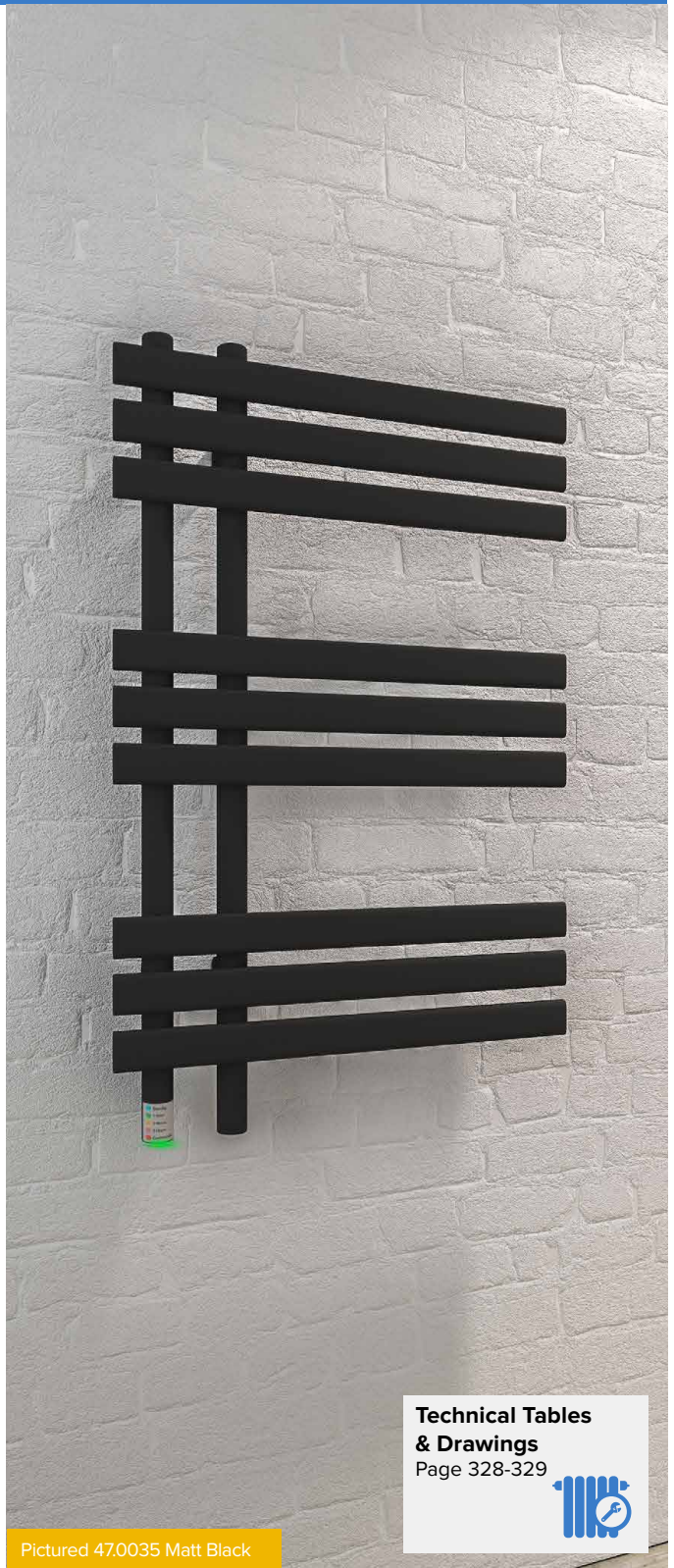

Pictured 47.0035 Matt Black

Technical Tables  
& Drawings  
Page 328-329



### FEATURES

- No fluid filling required
  - Just connect and Go
  - Material of Towel Rail : Mild Steel
  - IPX4 certificates (Zone 2 and 3)
  - 4 colours available from stock
  - 2 Year Manufacturer's Warranty\*
- \*With conditions



This product is electric only installation and cannot be used on a central heating system.

# Dry Element Range

## LODDON DRY ELEMENT

Loddon Dry Element Towel Rail - Matt White					
Size H x W	Watts	BTU	Code	£ Ex VAT	£ Inc VAT
800 x 500mm*	300	1024	47.0027	423.00	<b>507.60</b>
800 x 600mm*	350	1195	47.0028	446.00	<b>535.20</b>
1200 x 500mm	450	1536	47.0029	520.00	<b>624.00</b>
1200 x 600mm	500	1707	47.0030	549.00	<b>658.80</b>

Loddon Dry Element Towel Rail - Matt Black					
Size H x W	Watts	BTU	Code	£ Ex VAT	£ Inc VAT
800 x 500mm*	300	1024	47.0035	423.00	<b>507.60</b>
800 x 600mm*	350	1195	47.0036	446.00	<b>535.20</b>
1200 x 500mm	450	1536	47.0037	520.00	<b>624.00</b>
1200 x 600mm	500	1707	47.0038	549.00	<b>658.80</b>

Loddon Dry Element Towel Rail - Matt Anthracite					
Size H x W	Watts	BTU	Code	£ Ex VAT	£ Inc VAT
800 x 500mm*	300	1024	47.0031	423.00	<b>507.60</b>
800 x 600mm*	350	1195	47.0032	446.00	<b>535.20</b>
1200 x 500mm	450	1536	47.0033	520.00	<b>624.00</b>
1200 x 600mm	500	1707	47.0034	549.00	<b>658.80</b>

Loddon Dry Element Towel Rail - Chrome					
Size H x W	Watts	BTU	Code	£ Ex VAT	£ Inc VAT
800 x 500mm*	300	1024	47.0039	502.00	<b>602.40</b>
800 x 600mm*	350	1195	47.0040	561.00	<b>673.20</b>
1200 x 500mm	450	1536	47.0041	588.00	<b>705.60</b>
1200 x 600mm	500	1707	47.0042	646.00	<b>775.20</b>

\*The total height of this rail is 780mm

\*The total height of this rail is 780mm

### TECHNICAL INFORMATION

All measurements in Height by Width. Heat output based on  $\Delta T60^{\circ}C$ . Can not be fitted upside down. Comes with an information label in the front that can be removed. Projection from wall 100mm.

#### Colour Coded Boost Function

The Loddon Dry Element towel rail has a colour coded boost function which allows the length of time the rail runs for to be set.

It can be on standby, 1 hour, 2 hours, 3 hours or continuously running.



#### Concealed or Exposed Wiring Option

The Loddon Dry Element towel rail can be installed with two different wiring options; an exposed wiring installation or concealed wiring installation.

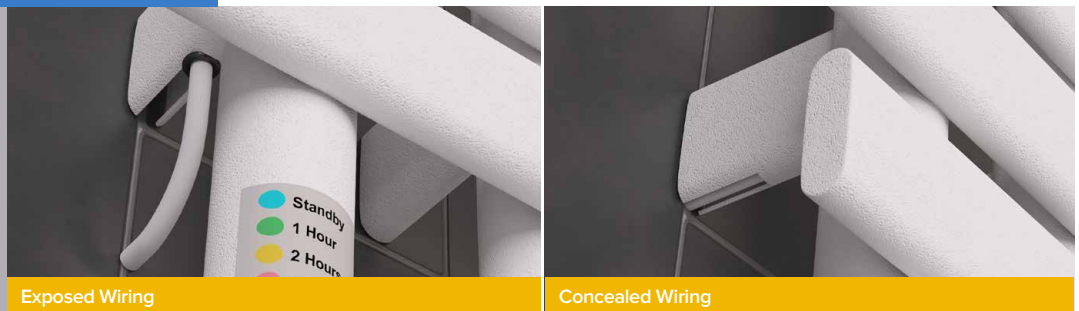

#### Matt White



#### Matt Anthracite



#### Matt Black



#### Chrome



# Dry Element Range

## KENNET DRY ELEMENT



Pictured 47.0049 Chrome



Pictured 47.0044 Matt Anthracite

Warranty

2

Year

All Electric

### FEATURES

- No fluid filling required
- Just connect and Go
- Material of Towel Rail : Mild Steel
- IPX4 certificates (Zone 2 and 3)
- 2 colours available from stock
- 2 Year Manufacturer's Warranty\*
- \*With conditions

### Technical Tables & Drawings

Page 328-329



This product is electric only installation and cannot be used on a central heating system.

### Kennet Dry Element Towel Rail - Matt Anthracite

Size H x W	Watts	BTU	Code	£ Ex VAT	£ Inc VAT
700 x 500mm*	120	410	47.0043	395.00	<b>474.00</b>
700 x 600mm*	150	512	47.0044	418.00	<b>501.60</b>
1200 x 500mm**	200	683	47.0045	469.00	<b>562.80</b>
1200 x 600mm**	230	785	47.0046	508.00	<b>609.60</b>

### Kennet Dry Element Towel Rail - Chrome

Size H x W	Watts	BTU	Code	£ Ex VAT	£ Inc VAT
700 x 500mm*	120	410	47.0047	451.00	<b>541.20</b>
700 x 600mm*	150	512	47.0048	470.00	<b>564.00</b>
1200 x 500mm**	200	683	47.0049	532.00	<b>638.40</b>
1200 x 600mm**	230	785	47.0050	572.00	<b>686.40</b>

\* Height shown excludes bottom control leg. Total height is 744.5mm

\*\* Height shown excludes bottom control leg. Total height is 1253mm

### TECHNICAL INFORMATION

All measurements in Height by Width. Heat output based on ▲T60°C. Can not be fitted upside down. Comes with an information label in the front that can be removed. Projection from wall 130mm.

### Colour Coded Boost Function

The Kennet Dry Element towel rail has a colour coded boost function which allows the length of time the rail runs for to be set. It can be on standby, 1 hour, 2 hours, 3 hours or continuously running.



# Dry Element Range

## EMSBURY DRY ELEMENT



Pictured 47.0025 Polished

Rear fixing metal wall brackets



### Technical Tables & Drawings

Page 328-329



### Warranty

2  
Year

### All Electric



Pictured 47.0024 Polished

### Emsbury Dry Element Towel Rail - Polished

Size H x W	Watts	BTU	Code	£ Ex VAT	£ Inc VAT
800 x 500mm	150	512	47.0023	411.00	<b>493.20</b>
800 x 600mm	200	683	47.0024	443.00	<b>531.60</b>
1200 x 500mm	250	854	47.0025	471.00	<b>565.20</b>
1200 x 600mm	300	1024	47.0026	491.00	<b>589.20</b>

### FEATURES

- No fluid filling required
- Comes with integrated On/Off button
- Just connect and Go
- Material of Towel Rail : Grade 304 Stainless Steel
- Rear fixing metal wall brackets
- IPX4 certificates (Zone 2 and 3)
- Only available as polished surface finishing
- 2 Year Manufacturer's Warranty\*

This product is electric only installation and cannot be used on a central heating system.

### TECHNICAL INFORMATION

All measurements in Height by Width. Heat output based on  $\Delta T60^{\circ}\text{C}$ . Can not be fitted upside down. Projection from wall 92mm.



Integrated On/Off Button

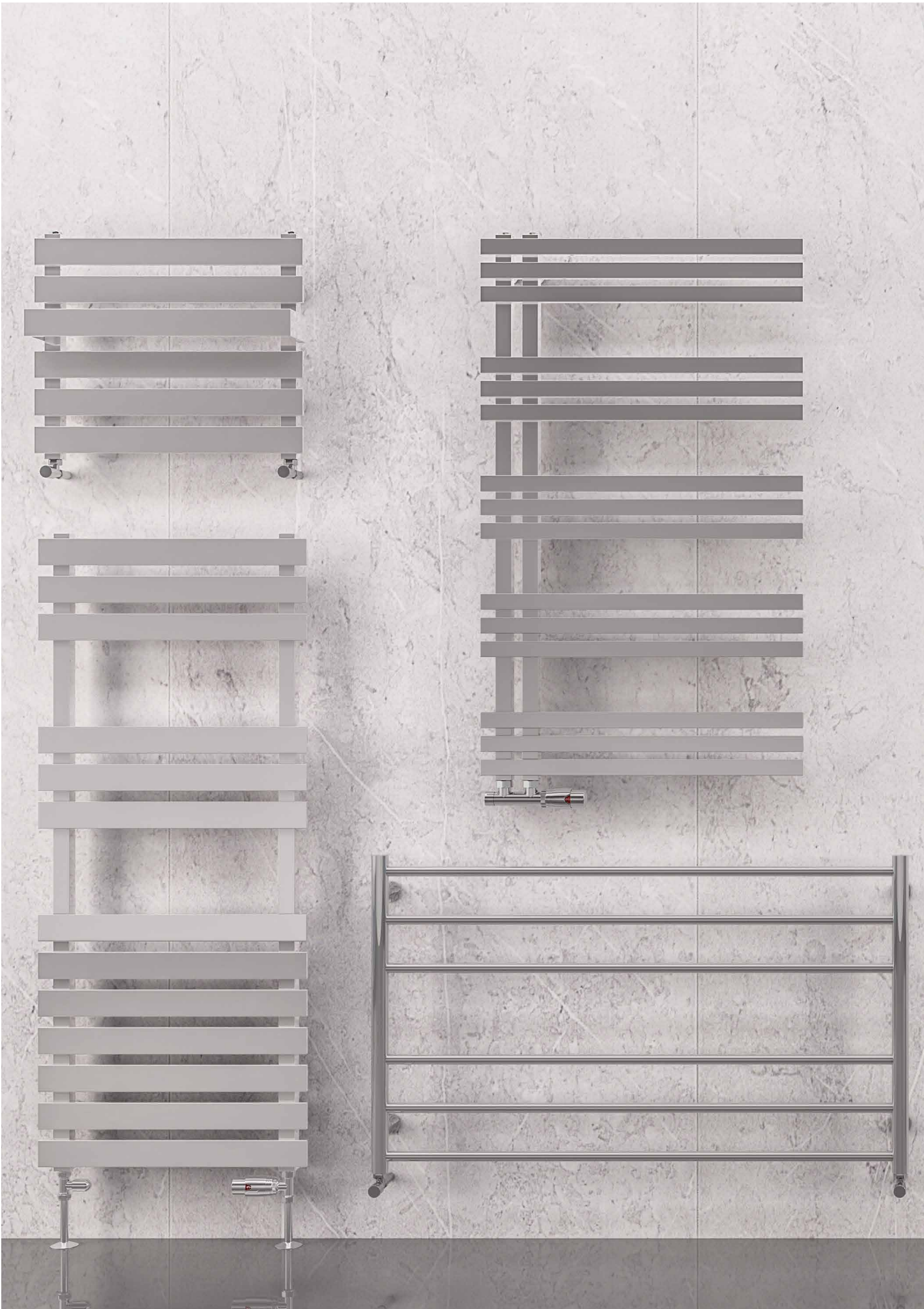

# Stainless Steel Range

Whilst retaining the features of a ladder rail, the stainless steel range produces a stylish contemporary look.

## Contents

Rizano, Polished	78
Violla, Polished	79
Biava Flat, Polished	80
Ascona, Polished	81



# Stainless Steel Range

## RIZANO

Can be reverse handed  
(Left or Right)



### Technical Tables & Drawings

Page 330-331



Furniture for illustration  
purposes only

Pictured 41.0250 Polished

Twin TRV's  
Page 304



Tappings: 50mm



Bar Dimensions (mm)

Horizontal Bars 30 x 15mm

This sophisticated, ultra modern radiator adds a hugely useful feature with its single sided towel bars.

### Rizano - Stainless Steel Polished

Size H x W	Watts	BTU	Element Output	Element Type	Code	£ Ex VAT	£ Inc VAT
1000 x 500mm	545	1859	300W	A, A+, D, E	41.0250	640.00	<b>768.00</b>
1000 x 600mm	626	2136	300W	A, A+, D, E	41.0251	880.00	<b>1056.00</b>

### FEATURES

- Grade 304 Stainless Steel material
  - Mirror polished surface (Chrome effect)
  - Can be single, dual fuel or all electric
  - Tested to BS EN 442 standards
  - Tappings at the top and bottom. Can be reverse handed (left or right)
  - Twin valves can be used with this towel rail
  - 5 Year Manufacturer's Warranty\*
- \* With conditions

### TECHNICAL INFORMATION

All measurements in Height by Width. Heat output based on  $\Delta T60^{\circ}\text{C}$ . Radiators that are electric only are restricted to the heat output of the elements. Element size can be increased to full capacity of rail if using element type D or E. For element types see pages 288-300. For matching valves see pages 301-309. For direct & indirect heating systems. Tappings are approx. 50mm and approx. 65mm off the wall. Price includes radiator and wall fixing sets, valves extra. Maximum working pressure: 4 bars.

Warranty

**5**

Year

Heating

All Electric

Dual-Fuel

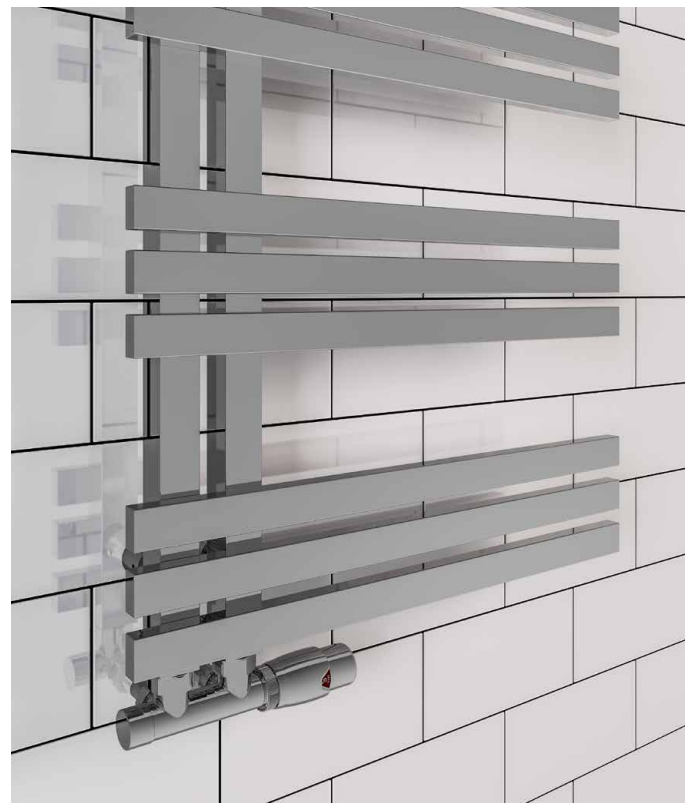



# Stainless Steel Range

VIOLLA

Pictured 91.0177 Polished



Warranty  
**5**  
Year

Heating

All Electric

Dual-Fuel

Rear fixing wall brackets

Pictured 91.0174 Polished



Technical Tables  
& Drawings  
Page 330-331



### FEATURES

- Grade 304 Stainless Steel material
- Mirror polished surface (Chrome effect)
- Can be single, dual fuel or all electric
- Tested to BS EN 442 standards
- Rear fixing wall brackets
- Tappings only at the bottom
- Hidden air vent at the back
- Flush finished tops
- 5 Year Manufacturer's Warranty\*
- \* With conditions

A take on the simple ladder rail design this radiator is both functional and minimalist. Rail spacing makes it easy to put a towel on all of the bars, making it the perfect family bathroom solution.

### Violla - Stainless Steel Polished

Size H x W	Watts	BTU	Element Output	Element Type	Code	£ Ex VAT	£ Inc VAT
590 x 1000mm	231	788	150W	A, A+, D, E, F, G	91.0171	424.00	<b>508.80</b>
790 x 500mm	199	679	100W	A, A+, D, E, F, G	91.0172	413.00	<b>495.60</b>
790 x 600mm	226	771	150W	A, A+, D, E, F, G	91.0173	441.00	<b>529.20</b>
1210 x 500mm	320	1092	150W	A, A+, D, E, F, G	91.0174	468.00	<b>561.60</b>
1210 x 600mm	366	1249	150W	A, A+, D, E, F, G	91.0175	490.00	<b>588.00</b>
1630 x 500mm	416	1419	150W	A, A+, D, E, F, G	91.0176	611.00	<b>733.20</b>
1630 x 600mm	474	1617	300W	A, A+, D, E, F, G	91.0177	722.00	<b>866.40</b>

### TECHNICAL INFORMATION

All measurements in Height by Width. Heat output based on  $\Delta T60^{\circ}\text{C}$ . Radiators that are electric only are restricted to the heat output of the elements. Element size can be increased to full capacity of rail if using element type D, E, F or G. (Type F & G Elements suitable for all electric only) For element types see pages 288-300. For matching valves see pages 301-309. For direct & indirect heating systems. Tappings are approx. 32mm less than the width of the rail and approx. 79mm off the wall. Prices include radiator and wall fixings sets, valves extra. Maximum working pressure: 4 bars.

# Stainless Steel Range

## BIAVA FLAT

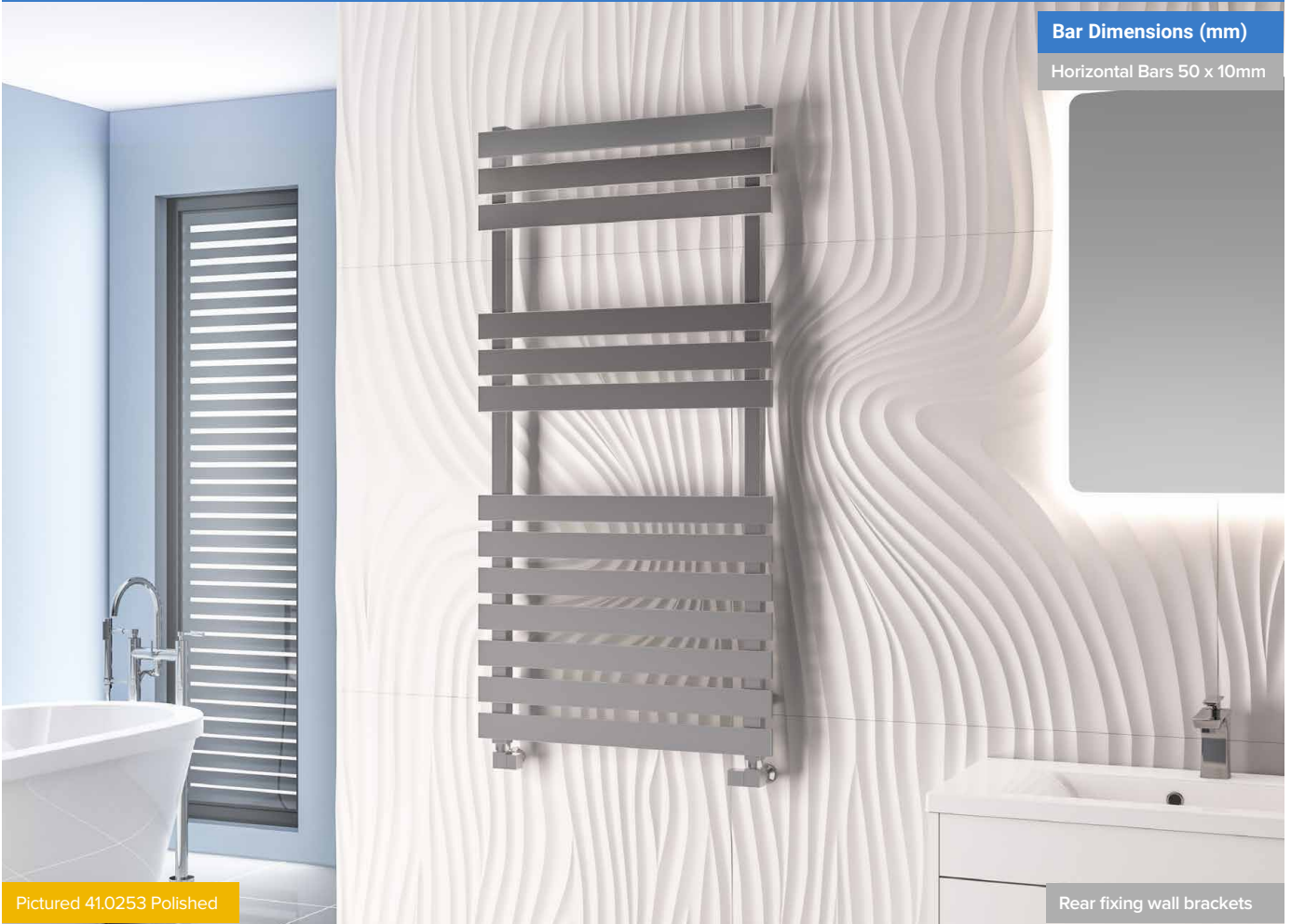

Pictured 41.0253 Polished

Whilst retaining the features of a ladder rail, this flat panelled radiator produces a stylish and contemporary look. The larger surface area of the flat panels allow for a higher heat output with no compromise on design.

### Biava Flat - Stainless Steel Polished

Size H x W	Watts	BTU	Element Output	Element Type	Code	£ Ex VAT	£ Inc VAT
1190 x 500mm	621	2119	300W	A, A+, D, E	41.0252	728.00	873.60
1190 x 600mm	712	2429	300W	A, A+, D, E	41.0253	793.00	951.60

### FEATURES

- Grade 304 Stainless Steel material
  - Mirror polished surface (Chrome effect)
  - Can be single, dual fuel or all electric
  - Tested to BS EN 442 standards
  - Rear fixing wall brackets
  - Tappings only at the bottom
  - Hidden air vent at the back
  - Flush finished tops
  - 5 Year Manufacturer's Warranty\*
- \* With conditions

**Technical Tables  
& Drawings**  
Page 330-331



### TECHNICAL INFORMATION

All measurements in Height by Width. Heat output based on  $\Delta T60^{\circ}\text{C}$ . Radiators that are electric only are restricted to the heat output of the elements. Element size can be increased to full capacity of rail if using element type D or E. For element types see pages 288-300. For matching valves see pages 301-309. For direct & indirect heating systems. Tappings are approx. 80mm less than the width of the rail and approx. 65mm off the wall. Prices include radiator and wall fixings sets, valves extra. Maximum working pressure: 4 bars.

Warranty

# 5

Year

Heating

All Electric

Dual-Fuel



# Stainless Steel Range

ASCONA

Rear fixing wall brackets

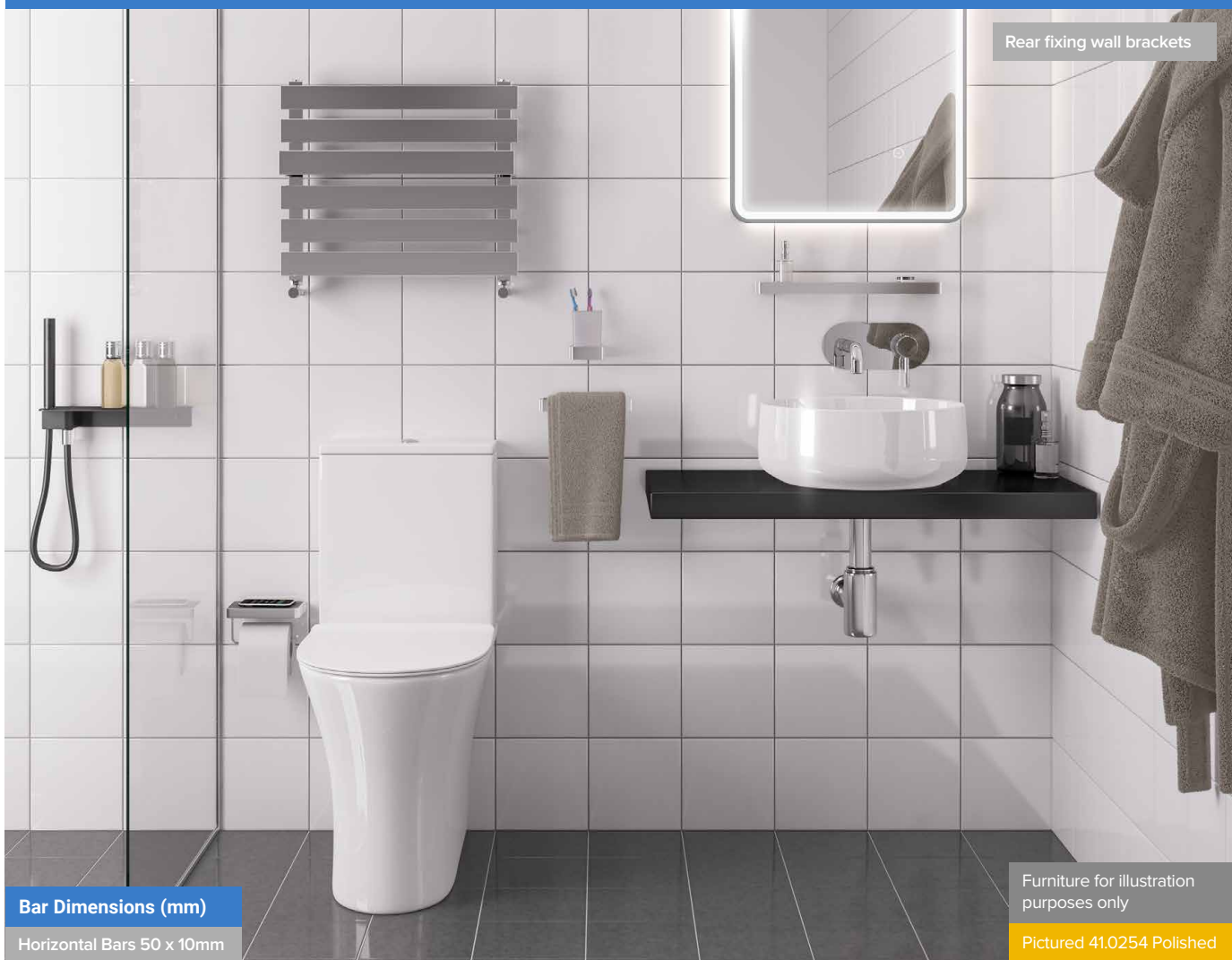

**Bar Dimensions (mm)**  
Horizontal Bars 50 x 10mm

Furniture for illustration purposes only

Pictured 41.0254 Polished

This sophisticated, ultra modern radiator adds a hugely useful feature with its single sided towel bars.

**Ascona - Stainless Steel Polished**

Size H x W	Watts	BTU	Element Output	Element Type	Code	£ Ex VAT	£ Inc VAT
420 x 500mm	280	955	150W	A, A+, D, E	41.0254	500.00	600.00

**FEATURES**

- Grade 304 Stainless Steel material
  - Mirror polished surface (Chrome effect)
  - Can be single, dual fuel or all electric
  - Tested to BS EN 442 standards
  - Rear fixing wall brackets
  - Tappings only at the bottom, with hidden air vent at the back
  - Flush finished tops
  - 5 Year Manufacturer's Warranty\*
- \* With conditions

**Technical Tables & Drawings**  
Page 330-331



**TECHNICAL INFORMATION**

All measurements in Height by Width. Heat output based on  $\Delta T60^{\circ}C$ . Radiators that are electric only are restricted to the heat output of the elements. Element size can be increased to full capacity of rail if using element type E. For element types see pages 288-300. For matching valves see pages 301-309. For direct & indirect heating systems. Tappings are approx. 60mm less than the width of the rail and approx. 45mm off the wall. Price includes radiator and wall fixing sets, valves extra. Maximum working pressure: 4 bars.



Warranty

5

Year

Heating

All Electric

Dual-Fuel



## Sub Section

# Designer Range

Our aim is to offer a statement piece radiator that allows maximum space to keep towels warm. In the designer range you can find a huge variety of towel rail styles and radiators using minimalistic, clean designs.vß

Contents			
Warrington Type10, Available in 3 colours - <b>NEW PRODUCT</b>	84-85	Rowsham Vertical & Horizontal, Matt White & Matt Anthracite	124-126
Warrington Type20, Available in 3 colours - <b>NEW PRODUCT</b>	86-87	Rowsham Towel Rail, Matt White & Matt Anthracite	127
Leonardo, Chrome & Brushed Brass	88	Tunstall Vertical, Available in 4 colours	128-129
Staverton Tube on Tube Straight, Available in 3 colours	89	Tunstall Horizontal, Available in 3 colours	130
Staverton Tube on Tube Curved, Chrome	90	Tunstall Towel Rail, Available in 4 colours	131
Biava Corinium, Chrome	91	Tunstall Double Vertical, Available in 3 colours	132-133
Defford, Available in 5 colours	92-93	Tunstall Double Horizontal, Available in 3 colours	134-135
Staverton, Available in 3 colours	94	Tunstall Double Towel Rail, Available in 3 colours	136
Mezzo Tondo, Chrome	95	Tunstall Mirror & Tunstall Double Mirror, Available in 3 colours	137
Pesaro, Chrome	95	Deddington Vertical, Available in 5 colours	138-139
Santero, Available in 4 colours	96-97	Deddington Horizontal, Available in 5 colours	140-141
Hurley, Available in 6 colours -	98-101	Deddington Towel Rail, Available in 5 colours	142-143
Helmsley, Available in 4 colours	102-103	Addington Type10, Gloss White & Matt Anthracite	144-147
Platani, Available in 5 colours	104-105	Addington Type10 Towel Rail, Gloss White & Matt Anthracite	148
Reinbach, Available in 5 colours	106-107	Addington Type10 Towel Hangers	149
Marlow, Available in 5 colours	108-109	Addington Type20, Gloss White & Matt Anthracite	150-153
Marlow E-Style, Available in 5 colours	110-111	Addington Type21 Horizontal, Gloss White & Matt Anthracite	154
Conwy, Available in 4 colours - <b>NEW PRODUCT</b>	112	Addington Type22 Horizontal, Gloss White & Matt Anthracite	155
Portchester, Available in 4 colours - <b>NEW PRODUCT</b>	113	Addington Type20 Towel Rail, Gloss White & Matt Anthracite	156
Lambourne, Available in 4 colours -	114-115	Addington Type21 Towel Rail, Gloss White & Matt Anthracite	157
Murano Vertical & Horizontal, Available in 4 colours	116-117		
Ryton, Available in 3 colours	118		
Kenilworth, Available in 3 colours	119		
Loxley, Available in 3 colours	120		
Eshton, Available in 3 colours	121		
Rubano Vertical & Horizontal, Gloss White & Matt Anthracite	122-123		

# Designer Range

## WARRINGTON TYPE 10



Pictured 41.0511 Gloss White with 41.0574 Towel Hanger



Pictured 41.0515 Matt Anthracite

Bar Dimensions (mm)  
Vertical Bars 68 x 12mm



Pictured 41.0528 Matt Black

Warranty  
**5**  
Year

Heating  

# Designer Range

## WARRINGTON TYPE 10

Warrington Designer Radiator will be the centre of attention in any room with its perfectly crafted elliptical front panels. Completing your radiator with the extra towel hangers has never been easier. Single panel Warrington Radiator is available in vertical & horizontal sizes and 3 colours.

### FEATURES

- 68x12mm vertical bars
- Tested to BS EN 442 standards
- Single profile construction
- 3 colours available from stock
- Not suitable for elements
- 5 Year Manufacturer's Warranty\*
- \* With conditions

**Technical Tables  
& Drawings**  
Page 334-335



Single profile construction

### 1800mm Height - Vertical

#### Warrington Type 10 Vertical Radiators - Gloss White

Size H x W	Watts	BTU	Code	£ Ex VAT	£ Inc VAT
1800 x 300mm	705	2405	41.0505	172.00	<b>206.40</b>
1800 x 376mm	882	3009	41.0508	205.00	<b>246.00</b>
1800 x 452mm	1059	3613	41.0511	239.00	<b>286.80</b>
1800 x 528mm	1234	4210	41.0514	271.00	<b>325.20</b>
1800 x 604mm	1411	4814	41.0517	305.00	<b>366.00</b>

### 600mm Height - Horizontal

#### Warrington Type 10 Horizontal Radiators - Gloss White

Size H x W	Watts	BTU	Code	£ Ex VAT	£ Inc VAT
600 x 452mm	397	1355	41.0520	123.00	<b>147.60</b>
600 x 604mm	529	1805	41.0523	152.00	<b>182.40</b>
600 x 832mm	728	2484	41.0526	195.00	<b>234.00</b>
600 x 1060mm	927	3163	41.0529	237.00	<b>284.40</b>
600 x 1212mm	1060	3617	41.0532	265.00	<b>318.00</b>

#### Warrington Type 10 Vertical Radiators - Matt Anthracite

Size H x W	Watts	BTU	Code	£ Ex VAT	£ Inc VAT
1800 x 300mm	705	2405	41.0506	177.00	<b>212.40</b>
1800 x 376mm	882	3009	41.0509	212.00	<b>254.40</b>
1800 x 452mm	1059	3613	41.0512	245.00	<b>294.00</b>
1800 x 528mm	1234	4210	41.0515	280.00	<b>336.00</b>
1800 x 604mm	1411	4814	41.0518	314.00	<b>376.80</b>

#### Warrington Type 10 Horizontal Radiators - Matt Anthracite

Size H x W	Watts	BTU	Code	£ Ex VAT	£ Inc VAT
600 x 452mm	397	1355	41.0521	126.00	<b>151.20</b>
600 x 604mm	529	1805	41.0524	156.00	<b>187.20</b>
600 x 832mm	728	2484	41.0527	200.00	<b>240.00</b>
600 x 1060mm	927	3163	41.0530	243.00	<b>291.60</b>
600 x 1212mm	1060	3617	41.0533	272.00	<b>326.40</b>

#### Warrington Type 10 Vertical Radiators - Matt Black

Size H x W	Watts	BTU	Code	£ Ex VAT	£ Inc VAT
1800 x 300mm	705	2405	41.0507	177.00	<b>212.40</b>
1800 x 376mm	882	3009	41.0510	212.00	<b>254.40</b>
1800 x 452mm	1059	3613	41.0513	245.00	<b>294.00</b>
1800 x 528mm	1234	4210	41.0516	280.00	<b>336.00</b>
1800 x 604mm	1411	4814	41.0519	314.00	<b>376.80</b>

#### Warrington Type 10 Horizontal Radiators - Matt Black

Size H x W	Watts	BTU	Code	£ Ex VAT	£ Inc VAT
600 x 452mm	397	1355	41.0522	126.00	<b>151.20</b>
600 x 604mm	529	1805	41.0525	156.00	<b>187.20</b>
600 x 832mm	728	2484	41.0528	200.00	<b>240.00</b>
600 x 1060mm	927	3163	41.0531	243.00	<b>291.60</b>
600 x 1212mm	1060	3617	41.0534	272.00	<b>326.40</b>

### TECHNICAL INFORMATION

All measurements in Height by Width. Heat output based on  $\Delta T60^{\circ}C$ . Not suitable for elements. For matching valves see pages 301-309. Comes with pre-fitted flow diverter, fitted in the middle of the bottom header. For indirect heating systems only. Tappings are the width of the rail and approx. 51mm off the wall. Projection from wall 84mm.

## WARRINGTON TOWEL HANGERS



#### Towel Hanger - Mirror Polished Premium

Size	Code	£ Ex VAT	£ Inc VAT
239mm	41.0565	53.00	<b>63.60</b>
300mm	41.0569	57.00	<b>68.40</b>
380mm	41.0573	62.00	<b>74.40</b>
500mm	41.0577	71.00	<b>85.20</b>



#### Towel Hanger - Gloss White

Size	Code	£ Ex VAT	£ Inc VAT
239mm	41.0566	50.00	<b>60.00</b>
300mm	41.0570	53.00	<b>63.60</b>
380mm	41.0574	58.00	<b>69.60</b>
500mm	41.0578	65.00	<b>78.00</b>



#### Towel Hanger - Matt Anthracite

Size	Code	£ Ex VAT	£ Inc VAT
239mm	41.0567	50.00	<b>60.00</b>
300mm	41.0571	53.00	<b>63.60</b>
380mm	41.0575	58.00	<b>69.60</b>
500mm	41.0579	65.00	<b>78.00</b>



#### Towel Hanger - Matt Black

Size	Code	£ Ex VAT	£ Inc VAT
239mm	41.0568	50.00	<b>60.00</b>
300mm	41.0572	53.00	<b>63.60</b>
380mm	41.0576	58.00	<b>69.60</b>
500mm	41.0580	65.00	<b>78.00</b>

### TECHNICAL INFORMATION

Material: **Steel (Premium: Stainless Steel - Grade 304)**

Warrington radiators do not come with towel hanger locations. Towel hangers can be fitted on any desired height, left or right handed and with the quantity chosen. Warrington Towel Hangers can be fitted on vertical & horizontal sizes.

Must be fitted before installation. Warrington Towel Hangers are only compatible with Warrington Type 10 & Type 20 radiators.

# Designer Range

## WARRINGTON TYPE 20



Pictured 41.0547 Gloss White

Bar Dimensions (mm)

Vertical Bars 68 x 12mm



Pictured 41.0539 Matt Anthracite with 41.0569 Towel Hanger



Warranty

5

Year

Heating



Pictured 41.0564 Matt Black



# Designer Range

## WARRINGTON TYPE 20

Warrington Designer Radiator will be the centre of attention in any room with its perfectly crafted elliptical front panels. Completing your radiator with the extra towel hangers has never been easier. Double panel Warrington Radiator is available in vertical & horizontal sizes and 3 colours.

### FEATURES

- 68x12mm vertical bars
- Tested to BS EN 442 standards
- Double profile construction
- 3 colours available from stock
- Not suitable for elements
- 5 Year Manufacturer's Warranty\*
- \* With conditions

**Technical Tables  
& Drawings**  
Page 334-335



Double profile construction

### 1800mm Height - Vertical

#### Warrington Type 20 Vertical Radiators - Gloss White

Size H x W	Watts	BTU	Code	£ Ex VAT	£ Inc VAT
1800 x 304mm	1367	4664	41.0535	271.00	<b>325.20</b>
1800 x 380mm	1709	5831	41.0538	340.00	<b>408.00</b>
1800 x 456mm	2050	6995	41.0541	398.00	<b>477.60</b>
1800 x 532mm	2293	8165	41.0544	458.00	<b>549.60</b>
1800 x 608mm	2735	9332	41.0547	519.00	<b>622.80</b>

### 600mm Height - Horizontal

#### Warrington Type 20 Horizontal Radiators - Gloss White

Size H x W	Watts	BTU	Code	£ Ex VAT	£ Inc VAT
600 x 456mm	728	2484	41.0550	182.00	<b>218.40</b>
600 x 608mm	970	3310	41.0553	230.00	<b>276.00</b>
600 x 836mm	1335	4555	41.0556	303.00	<b>363.60</b>
600 x 1064mm	1699	5797	41.0559	374.00	<b>448.80</b>
600 x 1216mm	1942	6626	41.0562	423.00	<b>507.60</b>

#### Warrington Type 20 Vertical Radiators - Matt Anthracite

Size H x W	Watts	BTU	Code	£ Ex VAT	£ Inc VAT
1800 x 304mm	1367	4664	41.0536	287.00	<b>344.40</b>
1800 x 380mm	1709	5831	41.0539	349.00	<b>418.80</b>
1800 x 456mm	2050	6995	41.0542	410.00	<b>492.00</b>
1800 x 532mm	2293	8165	41.0545	471.00	<b>565.20</b>
1800 x 608mm	2735	9332	41.0548	533.00	<b>639.60</b>

#### Warrington Type 20 Horizontal Radiators - Matt Anthracite

Size H x W	Watts	BTU	Code	£ Ex VAT	£ Inc VAT
600 x 456mm	728	2484	41.0551	187.00	<b>224.40</b>
600 x 608mm	970	3310	41.0554	237.00	<b>284.40</b>
600 x 836mm	1335	4555	41.0557	311.00	<b>373.20</b>
600 x 1064mm	1699	5797	41.0560	385.00	<b>462.00</b>
600 x 1216mm	1942	6626	41.0563	434.00	<b>520.80</b>

#### Warrington Type 20 Vertical Radiators - Matt Black

Size H x W	Watts	BTU	Code	£ Ex VAT	£ Inc VAT
1800 x 304mm	1367	4664	41.0537	287.00	<b>344.40</b>
1800 x 380mm	1709	5831	41.0540	349.00	<b>418.80</b>
1800 x 456mm	2050	6995	41.0543	410.00	<b>492.00</b>
1800 x 532mm	2293	8165	41.0546	471.00	<b>565.20</b>
1800 x 608mm	2735	9332	41.0549	533.00	<b>639.60</b>

#### Warrington Type 20 Horizontal Radiators - Matt Black

Size H x W	Watts	BTU	Code	£ Ex VAT	£ Inc VAT
600 x 456mm	728	2484	41.0552	187.00	<b>224.40</b>
600 x 608mm	970	3310	41.0555	237.00	<b>284.40</b>
600 x 836mm	1335	4555	41.0558	311.00	<b>373.20</b>
600 x 1064mm	1699	5797	41.0561	385.00	<b>462.00</b>
600 x 1216mm	1942	6626	41.0564	434.00	<b>520.80</b>

### TECHNICAL INFORMATION

All measurements in Height by Width. Heat output based on  $\Delta T 60^{\circ}\text{C}$ . Not suitable for elements. For matching valves see pages 301-309. Comes with pre-fitted flow diverter, fitted in the middle of the bottom header. For indirect heating systems only. Tappings are the width of the rail and approx. 51mm off the wall. Projection from wall 84mm.

## WARRINGTON TOWEL HANGERS

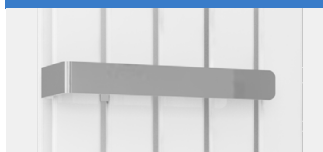

#### Towel Hanger - Mirror Polished Premium

Size	Code	£ Ex VAT	£ Inc VAT
239mm	41.0565	53.00	<b>63.60</b>
300mm	41.0569	57.00	<b>68.40</b>
380mm	41.0573	62.00	<b>74.40</b>
500mm	41.0577	71.00	<b>85.20</b>



#### Towel Hanger - Gloss White

Size	Code	£ Ex VAT	£ Inc VAT
239mm	41.0566	50.00	<b>60.00</b>
300mm	41.0570	53.00	<b>63.60</b>
380mm	41.0574	58.00	<b>69.60</b>
500mm	41.0578	65.00	<b>78.00</b>



#### Towel Hanger - Matt Anthracite

Size	Code	£ Ex VAT	£ Inc VAT
239mm	41.0567	50.00	<b>60.00</b>
300mm	41.0571	53.00	<b>63.60</b>
380mm	41.0575	58.00	<b>69.60</b>
500mm	41.0579	65.00	<b>78.00</b>



#### Towel Hanger - Matt Black

Size	Code	£ Ex VAT	£ Inc VAT
239mm	41.0568	50.00	<b>60.00</b>
300mm	41.0572	53.00	<b>63.60</b>
380mm	41.0576	58.00	<b>69.60</b>
500mm	41.0580	65.00	<b>78.00</b>

### TECHNICAL INFORMATION

Material: **Steel (Premium: Stainless Steel - Grade 304)**

Warrington radiators do not come with towel hanger locations. Towel hangers can be fitted on any desired height, left or right handed and with the quantity chosen. Warrington Towel Hangers can be fitted on vertical & horizontal sizes.

Must be fitted before installation. Warrington Towel Hangers are only compatible with Warrington Type 10 & Type 20 radiators.

# Designer Range

## LEONARDO

Warranty **5** Year
Heating 
All Electric 
Dual-Fuel



Pictured 41.0261 Chrome Can be reverse handed (Left or Right)

The single sided pipes on this wonderfully stylish Leonardo rail allows maximum hanging space.

**FEATURES**

- 42 x 14mm. horizontal bars
- Tested to BS EN 442 standards
- 5 Year manufacturer's warranty\*
- Can be reverse handed (left or right)
- Can be single or dual fuel, or all electric
- \* With conditions

**Technical Tables & Drawings**  
Page 332-333

Leonardo - Chrome							
Size H x W	Watts	BTU	Element Output	Element Type	Code	£ Ex VAT	£ Inc VAT
600 x 400mm	244	833	150W	A, A+, D, E, F, G	41.0255	286.00	<b>343.20</b>
600 x 500mm	288	983	150W	A, A+, D, E, F, G	41.0258	310.00	<b>372.00</b>
600 x 600mm	332	1133	150W	A, A+, D, E, F, G	41.0263	339.00	<b>406.80</b>
688 x 500mm	324	1105	150W	A, A+, D, E, F, G	41.0261	323.00	<b>387.60</b>
1200 x 400mm	465	1587	150W	A, A+, D, E, F, G	41.0256	481.00	<b>577.20</b>
1200 x 500mm	548	1870	300W	A, A+, D, E, F, G	41.0259	534.00	<b>640.80</b>
1200 x 600mm	631	2153	300W	A, A+, D, E, F, G	41.0264	580.00	<b>696.00</b>
1450 x 500mm	658	2245	300W	A, A+, D, E, F, G	41.0262	627.00	<b>752.40</b>
1800 x 400mm	665	2269	300W	A, A+, D, E, F, G	41.0257	670.00	<b>804.00</b>
1800 x 500mm	780	2661	450W	A, A+, D, E, F, G	41.0260	739.00	<b>886.80</b>
1800 x 600mm	896	3057	450W	A, A+, D, E, F, G	41.0265	807.00	<b>968.40</b>

Bar Dimensions (mm)  
Horizontal Bars 42 x 14mm



Pictured 41.0371 Brushed Brass

Leonardo - Brushed Brass							
Size H x W	Watts	BTU	Element Output	Element Type	Code	£ Ex VAT	£ Inc VAT
1200 x 500mm	548	1870	300W	A, A+, D, E, F, G	41.0371	713.00	<b>855.60</b>
1200 x 600mm	631	2153	300W	A, A+, D, E, F, G	41.0372	770.00	<b>924.00</b>

**TECHNICAL INFORMATION**

All measurements in Height by Width. Heat output based on ▲T60°C. Radiators that are electric only are restricted to the heat output of the elements. Element size can be increased to full capacity of rail if using element type D, E, F or G. (Type F & G Elements suitable for all electric only) For element types see pages 288-300. For matching valves see pages 301-309. For indirect heating systems only. Tappings are approx. 82mm and approx. 65mm off the wall. Price includes radiator and wall fixing sets, valves extra.

Brushed Brass colour shown in images are subject to the limitations of the printing process and may appear different.

# Designer Range

## STAVERTON - TUBE ON TUBE - STRAIGHT

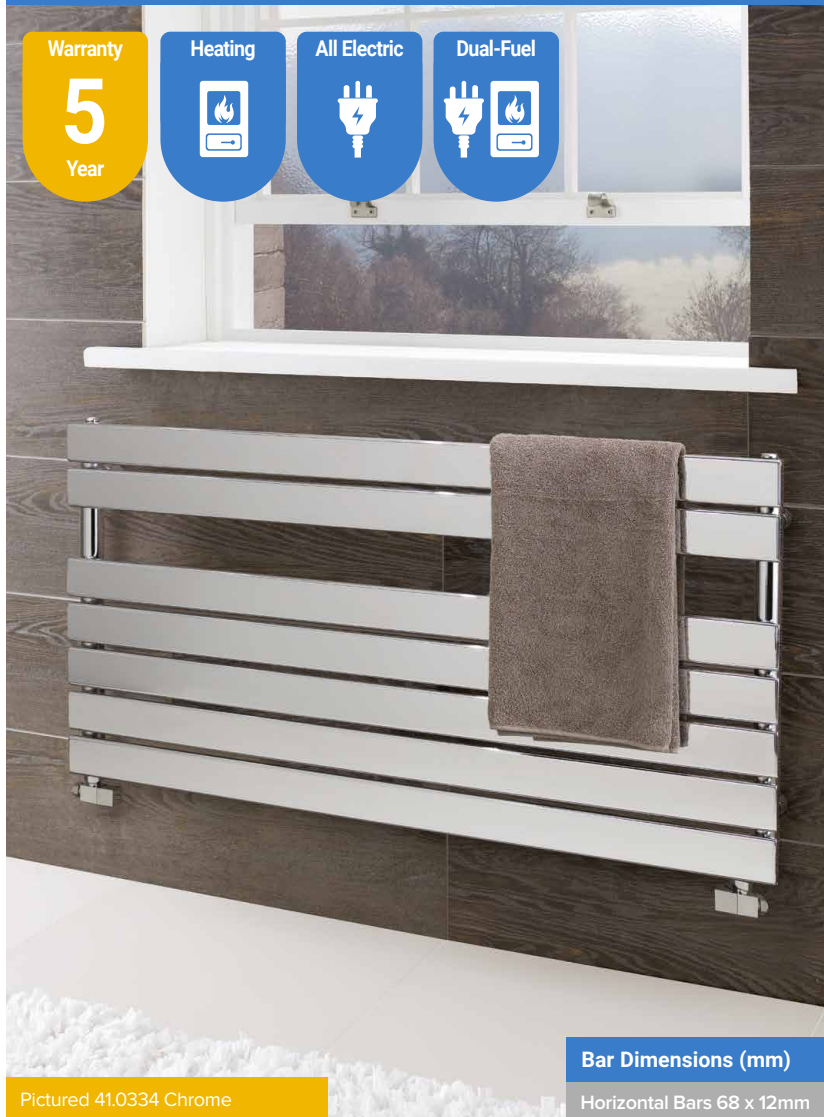

Warranty  
**5**  
Year

Heating

All Electric

Dual-Fuel

Bar Dimensions (mm)

Pictured 41.0334 Chrome

Horizontal Bars 68 x 12mm



Rear fixing wall brackets

Pictured 41.0375 Brushed Brass

The Staveron Tube on Tube takes the design one step further with a higher output.

### Staveron - Tube on Tube - Straight Gloss White

Size H x W	Watts	BTU	Element Output	Element Type	Code	£ Ex VAT	£ Inc VAT
600 x 400mm	364	1242	150W	A, A+, D, E, F, G	41.0190	231.00	277.20
600 x 500mm	432	1474	150W	A, A+, D, E, F, G	41.0193	251.00	301.20
600 x 600mm	500	1706	300W	A, A+, D, E, F, G	41.0196	273.00	327.60
1200 x 400mm	651	2221	300W	A, A+, D, E, F, G	41.0191	372.00	446.40
1200 x 500mm	766	2614	450W	A, A+, D, E, F, G	41.0194	387.00	464.40
1200 x 600mm	883	3013	450W	A, A+, D, E, F, G	41.0197	425.00	510.00
1800 x 400mm	1014	3460	600W	A, A+, D, E, F, G	41.0192	535.00	642.00
1800 x 500mm	1198	4088	600W	A, A+, D, E, F, G	41.0195	562.00	674.40
1800 x 600mm	1382	4715	750W	A, A+, D, E, F, G	41.0198	620.00	744.00

### Staveron - Tube on Tube - Straight Chrome

Size H x W	Watts	BTU	Element Output	Element Type	Code	£ Ex VAT	£ Inc VAT
1200 x 500mm	606	2068	300W	A, A+, D, E, F, G	41.0375	893.00	1071.60
1200 x 600mm	697	2378	300W	A, A+, D, E, F, G	41.0376	966.00	1159.20

### Staveron - Tube on Tube - Straight Brushed Brass

Size H x W	Watts	BTU	Element Output	Element Type	Code	£ Ex VAT	£ Inc VAT
600 x 400mm	288	983	150W	A, A+, D, E, F, G	41.0181	401.00	481.20
600 x 500mm	340	1160	150W	A, A+, D, E, F, G	41.0184	437.00	524.40
600 x 600mm	394	1344	150W	A, A+, D, E, F, G	41.0187	476.00	571.20
600 x 1000mm	603	2057	300W	A, A+, D, E, F, G	41.0333	587.00	704.40
600 x 1200mm	710	2423	300W	A, A+, D, E, F, G	41.0334	607.00	728.40
800 x 1000mm	779	2658	450W	A, A+, D, E, F, G	41.0335	678.00	813.60
800 x 1200mm	916	3125	450W	A, A+, D, E, F, G	41.0336	766.00	919.20
1200 x 400mm	514	1754	300W	A, A+, D, E, F, G	41.0182	685.00	822.00
1200 x 500mm	606	2068	300W	A, A+, D, E, F, G	41.0185	721.00	865.20
1200 x 600mm	697	2378	300W	A, A+, D, E, F, G	41.0188	790.00	948.00
1800 x 400mm	802	2736	450W	A, A+, D, E, F, G	41.0183	958.00	1149.60
1800 x 500mm	946	3228	450W	A, A+, D, E, F, G	41.0186	1010.00	1212.00
1800 x 600mm	1092	3726	600W	A, A+, D, E, F, G	41.0189	1179.00	1414.80

### FEATURES

- 68 x 12mm. horizontal bars
- Rear fixing wall brackets
- Tested to BS EN 442 standards
- 5 Year manufacturer's warranty\*
- Can be single or dual fuel, or all electric
- \* With conditions

### Technical Tables & Drawings

Page 336-337



### TECHNICAL INFORMATION

All measurements in Height by Width. Heat output based on  $\Delta T60^{\circ}C$ . Radiators that are electric only are restricted to the heat output of the elements. Element size can be increased to full capacity of rail if using element type D, E, F or G. (Type F & G Elements suitable for all electric only) For element types see pages 288-300. For matching valves see pages 301-309. For indirect heating systems only. Tappings are approx. 50mm less than the width of the rail and approx. 65mm off the wall. Price includes radiator and wall fixing sets, valves extra.

Brushed Brass colour shown in images are subject to the limitations of the printing process and may appear different.

# Designer Range

## STAVERTON - TUBE ON TUBE - CURVED

Bar Dimensions (mm)  
Horizontal Bars 42 x 14mm



Pictured 41.0234 Chrome

Rear fixing wall brackets

The Staverton Tube on Tube Curved allows the hanging of larger, fluffier towels for the ultimate luxury.

Staverton - Tube on Tube - Curved Chrome							
Size H x W	Watts	BTU	Element Output	Element Type	Code	£ Ex VAT	£ Inc VAT
600 x 500mm	328	1119	150W	A, A+, D, E, F, G	41.0232	387.00	<b>464.40</b>
600 x 600mm	378	1290	150W	A, A+, D, E, F, G	41.0233	425.00	<b>510.00</b>
1200 x 500mm	628	2143	300W	A, A+, D, E, F, G	41.0234	678.00	<b>813.60</b>
1200 x 600mm	722	2463	450W	A, A+, D, E, F, G	41.0235	743.00	<b>891.60</b>
1800 x 500mm	928	3166	450W	A, A+, D, E, F, G	41.0236	962.00	<b>1154.40</b>
1800 x 600mm	1067	3641	600W	A, A+, D, E, F, G	41.0237	1060.00	<b>1272.00</b>

**FEATURES**

- 42 x 14mm. horizontal bars
  - Rear fixing wall brackets
  - Tested to BS EN 442 standards
  - 5 Year manufacturer's warranty\*
  - Can be single or dual fuel, or all electric
- \* With conditions

**Technical Tables & Drawings**

Page 336-337



**TECHNICAL INFORMATION**

All measurements in Height by Width. Heat output based on  $\Delta T60^{\circ}C$ . Radiators that are electric only are restricted to the heat output of the elements. Element size can be increased to full capacity of rail if using element type D, E, F or G. (Type F & G Elements suitable for all electric only) For element types see pages 288-300. For matching valves see pages 301-309. For indirect heating systems only. Tappings are approx. 45mm less than the width of the rail and approx. 65mm off the wall. Price includes radiator and wall fixing sets, valves extra.

Warranty

5

Year

Heating

All Electric

Dual-Fuel



Pictured 41.0234 Chrome

# Designer Range

## BIAVA CORINIUM

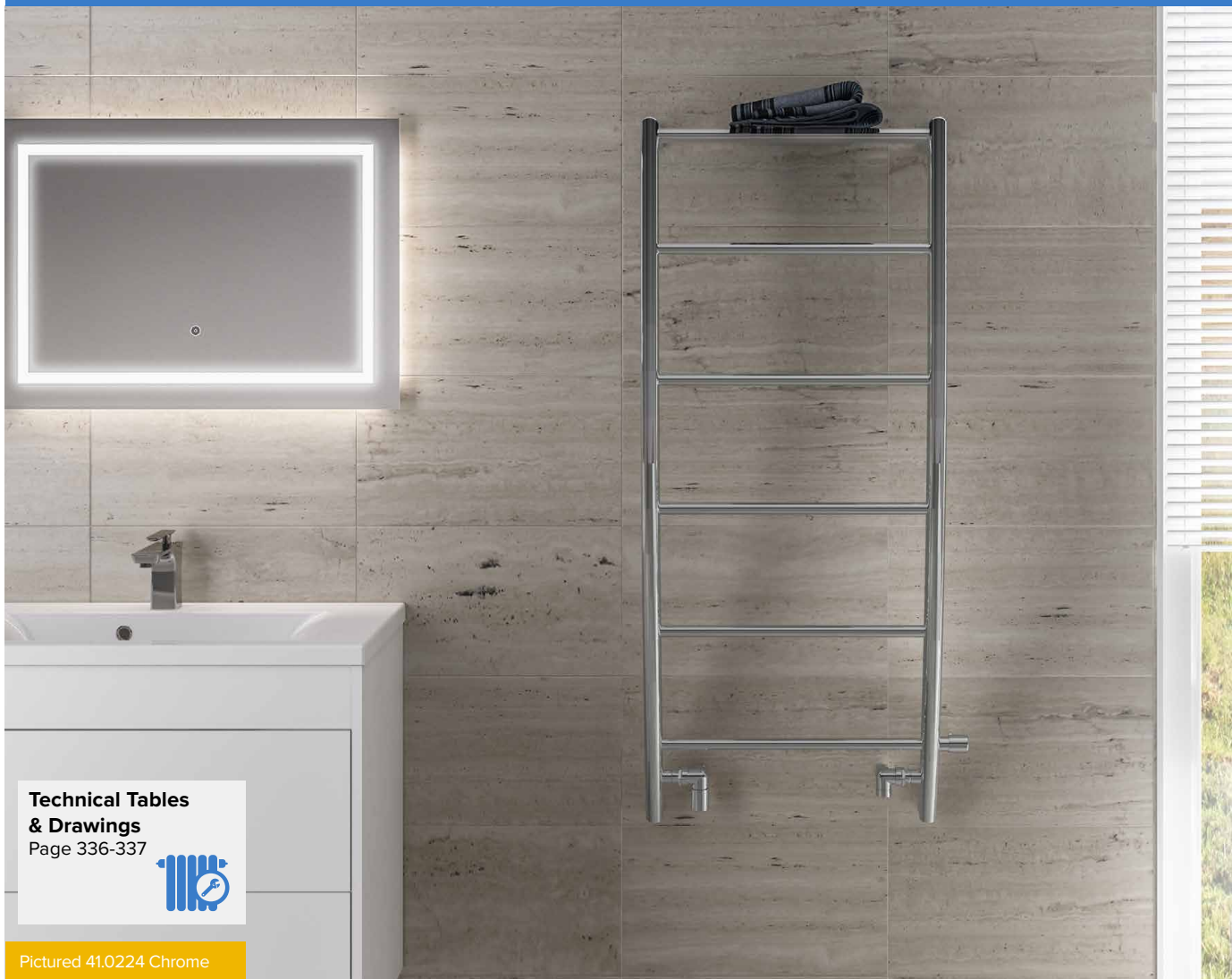

Technical Tables  
& Drawings  
Page 336-337



Pictured 41.0224 Chrome



Pictured 41.0224 Chrome

The Corinium rail is a contemporary unique design with a practical built in heated towel rail shelf at the top for stacking those larger towels. It's projection from the wall is 225mm.

Biava Corinium - Chrome							
Size H x W	Watts	BTU	Element Output	Element Type	Code	£ Ex VAT	£ Inc VAT
1200 x 500mm	304	1037	150W	A, A+, C, E, H	41.0222	294.00	<b>352.80</b>
1200 x 600mm	330	1126	150W	A, A+, C, E, H	41.0224	306.00	<b>367.20</b>

### FEATURES

- Tested to BS EN 442 standards
  - 5 Year manufacturer's warranty\*
  - Can be single or dual fuel, or all electric
- \* With conditions

### TECHNICAL INFORMATION

All measurements in Height by Width. Heat output based on  $\Delta T60^{\circ}\text{C}$ . Radiators that are electric only are restricted to the heat output of the elements. Element size can be increased to full capacity of rail if using element type C, E or H. For element types see pages 288-300. For matching valves see pages 301-309. For indirect heating systems only. Tappings are approx. 100mm less than the width of the rail. Price includes radiator and wall fixing sets, valves extra. Projection from wall 225mm.

Warranty

5

Year

Heating

All Electric

Dual-Fuel

# Designer Range

## DEFFORD

Chrome



Pictured 89.1303 Chrome

**Bar Dimensions (mm)**

Horizontal Bars 40 x 10mm  
Vertical Bars 40 x 30mm

Matt Black

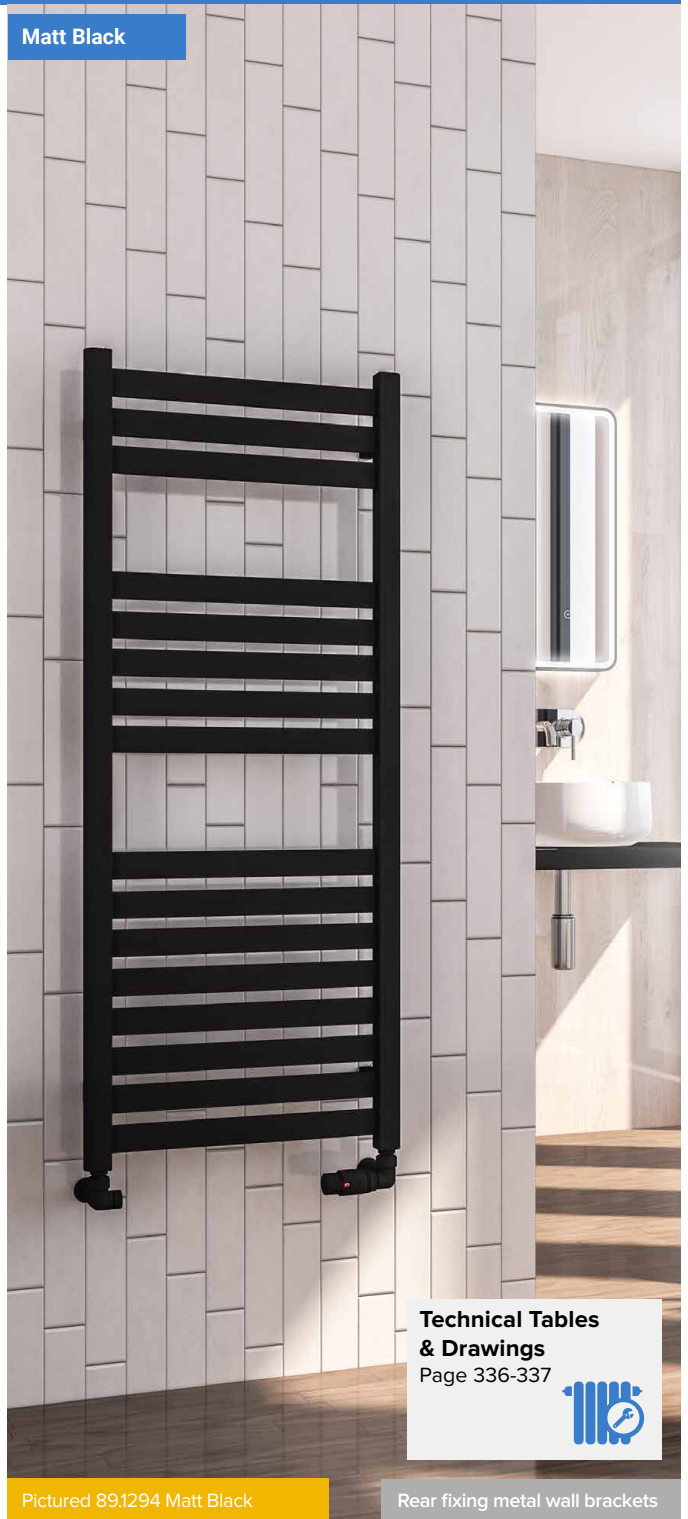

Pictured 89.1294 Matt Black

**Technical Tables & Drawings**  
Page 336-337



Rear fixing metal wall brackets

Defford has been specifically designed to give maximum space for your towels and can produce enough warmth to heat a bathroom.

**FEATURES**

- 40 x 10mm. horizontal bars with 40 x 30mm. vertical D profile
  - Tested to BS EN 442 standards
  - Rear fixing metal wall brackets
  - 5 colours available from stock
  - 5 Year manufacturer's warranty\*
  - Can be single or dual fuel, or all electric
- \* With conditions



Warranty

**5**

Year

Heating

All Electric

Dual-Fuel

# Designer Range

## DEFFORD

### Defford Towel Rail - Gloss White

Size H x W	Watts	BTU	Element Output	Element Type	Code	£ Ex VAT	£ Inc VAT
800 x 500mm	405	1382	150W	A, A+, D, E, F, G	89.1274	124.00	<b>148.80</b>
800 x 600mm	467	1594	150W	A, A+, D, E, F, G	89.1275	138.00	<b>165.60</b>
1200 x 500mm	603	2058	300W	A, A+, D, E, F, G	89.1276	197.00	<b>236.40</b>
1200 x 600mm	695	2372	300W	A, A+, D, E, F, G	89.1277	223.00	<b>267.60</b>
1800 x 500mm	892	3044	450W	A, A+, D, E, F, G	89.1278	276.00	<b>331.20</b>
1800 x 600mm	1029	3511	450W	A, A+, D, E, F, G	89.1279	303.00	<b>363.60</b>

### Defford Towel Rail - Matt Grey

Size H x W	Watts	BTU	Element Output	Element Type	Code	£ Ex VAT	£ Inc VAT
800 x 500mm	405	1382	150W	A, A+, D, E, F, G	89.1280	124.00	<b>148.80</b>
800 x 600mm	467	1594	150W	A, A+, D, E, F, G	89.1281	138.00	<b>165.60</b>
1200 x 500mm	603	2058	300W	A, A+, D, E, F, G	89.1282	197.00	<b>236.40</b>
1200 x 600mm	695	2372	300W	A, A+, D, E, F, G	89.1283	223.00	<b>267.60</b>
1800 x 500mm	892	3044	450W	A, A+, D, E, F, G	89.1284	276.00	<b>331.20</b>
1800 x 600mm	1029	3511	450W	A, A+, D, E, F, G	89.1285	303.00	<b>363.60</b>

### Defford Towel Rail - Chrome

Size H x W	Watts	BTU	Element Output	Element Type	Code	£ Ex VAT	£ Inc VAT
800 x 500mm	250	853	150W	A, A+, D, E, F, G	89.1298	182.00	<b>218.40</b>
800 x 600mm	286	976	150W	A, A+, D, E, F, G	89.1299	205.00	<b>246.00</b>
1200 x 500mm	371	1266	150W	A, A+, D, E, F, G	89.1300	322.00	<b>386.40</b>
1200 x 600mm	424	1447	150W	A, A+, D, E, F, G	89.1301	359.00	<b>430.80</b>
1800 x 500mm	555	1894	300W	A, A+, D, E, F, G	89.1302	461.00	<b>553.20</b>
1800 x 600mm	636	2171	300W	A, A+, D, E, F, G	89.1303	525.00	<b>630.00</b>

### Defford Towel Rail - Matt Anthracite

Size H x W	Watts	BTU	Element Output	Element Type	Code	£ Ex VAT	£ Inc VAT
800x500mm	405	1382	150W	A, A+, D, E, F, G	89.1286	124.00	<b>148.80</b>
800x600mm	467	1594	150W	A, A+, D, E, F, G	89.1287	138.00	<b>165.60</b>
1200x500mm	603	2058	300W	A, A+, D, E, F, G	89.1288	197.00	<b>236.40</b>
1200x600mm	695	2372	300W	A, A+, D, E, F, G	89.1289	223.00	<b>267.60</b>
1800x500mm	892	3044	450W	A, A+, D, E, F, G	89.1290	276.00	<b>331.20</b>
1800x600mm	1029	3511	450W	A, A+, D, E, F, G	89.1291	303.00	<b>363.60</b>

### Defford Towel Rail - Matt Black

Size H x W	Watts	BTU	Element Output	Element Type	Code	£ Ex VAT	£ Inc VAT
800x500mm	405	1382	150W	A, A+, D, E, F, G	89.1292	124.00	<b>148.80</b>
800x600mm	467	1594	150W	A, A+, D, E, F, G	89.1293	138.00	<b>165.60</b>
1200x500mm	603	2058	300W	A, A+, D, E, F, G	89.1294	197.00	<b>236.40</b>
1200x600mm	695	2372	300W	A, A+, D, E, F, G	89.1295	223.00	<b>267.60</b>
1800x500mm	892	3044	450W	A, A+, D, E, F, G	89.1296	276.00	<b>331.20</b>
1800x600mm	1029	3511	450W	A, A+, D, E, F, G	89.1297	303.00	<b>363.60</b>

### D Shape Vent Caps Page 313



### TECHNICAL INFORMATION

All measurements in Height by Width. Heat output based on  $\Delta T60^{\circ}C$ . Radiators that are electric only are restricted to the heat output of the elements. Element size can be increased to full capacity of rail if using element type D, E, F or G. (Type F & G Elements suitable for all electric only) For element types see pages 288-300. For matching valves see pages 301-309. For indirect heating systems only. Tappings are approx. 45mm less than the width of the rail and approx. 80mm off the wall. Price includes radiator and wall fixing sets, valves extra.



# Designer Range

## STAVERTON

Rear fixing metal wall brackets  
(only for brushed brass colour)



Pictured 41.0373 Brushed Brass

Brushed Brass colour shown in images are subject to the limitations of the printing process and may appear different.

Warranty  
**5**  
Year

Heating



All Electric



Dual-Fuel



Pictured 41.0131 Chrome

Bar Dimensions (mm)

Horizontal Bars 42 x 14mm  
Vertical Bars 40 x 30mm

A modern style towel rail with horizontal flat bars, that still allows maximum space for keeping your towels warm.

### FEATURES

- 42 x 14mm. horizontal bars
- Tested to BS EN 442 standards
- 5 Year manufacturer's warranty\*
- Comes in chrome, brushed brass or white finish
- Can be single or dual fuel, or all electric
- \* With conditions

### Technical Tables & Drawings

Page 338-339



### Staverton - Brushed Brass

Size H x W	Watts	BTU	Element Output	Element Type	Code	£ Ex VAT	£ Inc VAT
1200 x 500mm	523	1784	300W	A, A+, D, E, F, G	41.0373	598.00	<b>717.60</b>
1200 x 600mm	611	2085	300W	A, A+, D, E, F, G	41.0374	644.00	<b>772.80</b>

### Staverton - Gloss White

Size H x W	Watts	BTU	Element Output	Element Type	Code	£ Ex VAT	£ Inc VAT
600 x 400mm	276	942	150W	A, A+, D, E, F, G	41.0136	125.00	<b>150.00</b>
600 x 500mm	332	1133	150W	A, A+, D, E, F, G	41.0139	136.00	<b>163.20</b>
600 x 600mm	388	1324	150W	A, A+, D, E, F, G	41.0142	146.00	<b>175.20</b>
1200 x 400mm	552	1883	300W	A, A+, D, E, F, G	41.0137	203.00	<b>243.60</b>
1200 x 500mm	665	2269	300W	A, A+, D, E, F, G	41.0140	217.00	<b>260.40</b>
1200 x 600mm	776	2648	450W	A, A+, D, E, F, G	41.0143	239.00	<b>286.80</b>
1800 x 400mm	829	2829	450W	A, A+, D, E, F, G	41.0138	280.00	<b>336.00</b>
1800 x 500mm	996	3398	600W	A, A+, D, E, F, G	41.0141	305.00	<b>366.00</b>
1800 x 600mm	1164	3972	600W	A, A+, D, E, F, G	41.0144	334.00	<b>400.80</b>

### Staverton - Chrome

Size H x W	Watts	BTU	Element Output	Element Type	Code	£ Ex VAT	£ Inc VAT
600 x 400mm	217	740	100W	A, A+, D, E, F, G	41.0127	215.00	<b>258.00</b>
600 x 500mm	261	891	150W	A, A+, D, E, F, G	41.0130	248.00	<b>297.60</b>
600 x 600mm	305	1041	150W	A, A+, D, E, F, G	41.0133	258.00	<b>309.60</b>
1200 x 400mm	435	1484	150W	A, A+, D, E, F, G	41.0128	372.00	<b>446.40</b>
1200 x 500mm	523	1784	300W	A, A+, D, E, F, G	41.0131	412.00	<b>494.40</b>
1200 x 600mm	611	2085	300W	A, A+, D, E, F, G	41.0134	451.00	<b>541.20</b>
1800 x 400mm	652	2225	300W	A, A+, D, E, F, G	41.0129	529.00	<b>634.80</b>
1800 x 500mm	784	2675	450W	A, A+, D, E, F, G	41.0132	585.00	<b>702.00</b>
1800 x 600mm	916	3125	450W	A, A+, D, E, F, G	41.0135	649.00	<b>778.80</b>

### TECHNICAL INFORMATION

All measurements in Height by Width. Heat output based on  $\Delta T60^{\circ}\text{C}$ . Radiators that are electric only are restricted to the heat output of the elements. Element size can be increased to full capacity of rail if using element type D, E, F or G. (Type F & G Elements suitable for all electric only) For element types see pages 288-300. For matching valves see pages 301-309. For indirect heating systems only. Tappings are approx. 45mm less than the width of the rail and approx. 70mm off the wall. Price includes radiator and wall fixing sets, valves extra.

### Round Vent Caps

Page 313





# Designer Range

## MEZZO TONDO



Pictured 41.0248 Chrome

The curves on this rail allow maximum space for the whole family to warm towels easily, without compromising on space in the room due to the slimline design.

### Mezzo Tondo - Chrome

Size H x W	Watts	BTU	Element Output	Element Type	Code	£ Ex VAT	£ Inc VAT
1600 x 320mm Chrome	574	1958	N/A	N/A	41.0248	481.00	577.20

#### FEATURES

- Tested to BS EN 442 standards
  - 5 Year manufacturer's warranty\*
  - Not suitable for elements
- \* With conditions

#### Technical Tables & Drawings

Page 338-339



#### TECHNICAL INFORMATION

All measurements in Height by Width. Heat output based on  $\Delta T60^{\circ}\text{C}$ . Radiators that are electric only are restricted to the heat output of the elements. Element size can be increased to full capacity of rail if using element type D or E. For element types see pages 288-300. For matching valves see pages 301-309. For indirect heating systems only. Tappings are approx. 286mm and approx. 65mm off the wall. Price includes radiator and wall fixing sets, valves extra.

## PESARO



Pictured 41.0328 Chrome

A designer towel rail that allows the hanging of up to six towels at once. This statement piece has a unique design for those who want to make a bold statement.

### Pesaro - Chrome

Size H x W	Watts	BTU	Element Output	Element Type	Code	£ Ex VAT	£ Inc VAT
1005 x 550mm	349	1191	150W	A, A+, D, E, F, G	41.0328	478.00	573.60

#### FEATURES

- Tested to BS EN 442 standards
  - 5 Year manufacturer's warranty\*
  - Can be single or dual fuel, or all electric
- \* With conditions

#### Technical Tables & Drawings

Page 338-339



#### TECHNICAL INFORMATION

All measurements in Height by Width. Heat output based on  $\Delta T60^{\circ}\text{C}$ . Radiators that are electric only are restricted to the heat output of the elements. Element size can be increased to full capacity of rail if using element type D, E, F or G. (Type F & G Elements suitable for all electric only) For element types see pages 288-300. For matching valves see pages 301-309. For indirect heating systems only. Tappings are approx. 80mm and approx. 65mm off the wall. Price includes radiator and wall fixing sets, valves extra.

### Round Vent Caps

Page 313

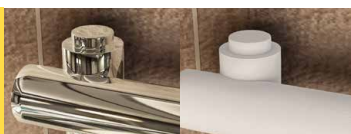

Warranty

Heating

5

Year



### Round Vent Caps

Page 313



Warranty

Heating

All Electric

Dual-Fuel

5

Year



# Designer Range

## SANTERO



**Bar Dimensions (mm)**  
 Horizontal Bars 75 x 15mm  
 Vertical Bars 40 x 30mm

Pictured 89.1327 Chrome



Pictured 89.1307 Gloss White

Rear fixing metal wall brackets

Warranty  
**5**  
 Year

Heating

All Electric

Dual-Fuel

An admired design in the Designer Range, Santero, has even wider horizontal flat bars than Defford or Staverton. Warmth has never been this easy to achieve. Grab your wet towels and use Santero Towel Rail to feel the constant warmth.

**FEATURES**

- 75 x 15mm. horizontal bars and 40 x 30mm. vertical D profiles
- Rear fixing metal wall brackets
- Tested to BS EN 442 standards
- 4 colours available from stock
- Can be single, dual fuel or all electric
- 5 Year Manufacturer's Warranty\*
- \* With conditions



**Technical Tables & Drawings**  
 Page 338-339



# Designer Range

**SANTERO**
**Santero Towel Rail - Gloss White**

Size H x W	Watts	BTU	Element Output	Element Type	Code	£ Ex VAT	£ Inc VAT
800 x 500mm	430	1468	150W	A, A+, D, E, F, G	89.1304	241.00	<b>289.20</b>
800 x 600mm	509	1737	150W	A, A+, D, E, F, G	89.1305	283.00	<b>339.60</b>
1200 x 500mm	633	2160	300W	A, A+, D, E, F, G	89.1306	311.00	<b>373.20</b>
1200 x 600mm	749	2556	300W	A, A+, D, E, F, G	89.1307	364.00	<b>436.80</b>
1800 x 500mm	932	3180	450W	A, A+, D, E, F, G	89.1308	431.00	<b>517.20</b>
1800 x 600mm	1104	3767	450W	A, A+, D, E, F, G	89.1309	503.00	<b>603.60</b>

**Santero Towel Rail - Matt Black**

Size H x W	Watts	BTU	Element Output	Element Type	Code	£ Ex VAT	£ Inc VAT
800 x 500mm	430	1468	150W	A, A+, D, E, F, G	89.1316	241.00	<b>289.20</b>
800 x 600mm	509	1737	150W	A, A+, D, E, F, G	89.1317	283.00	<b>339.60</b>
1200 x 500mm	633	2160	300W	A, A+, D, E, F, G	89.1318	311.00	<b>373.20</b>
1200 x 600mm	749	2556	300W	A, A+, D, E, F, G	89.1319	364.00	<b>436.80</b>
1800 x 500mm	932	3180	450W	A, A+, D, E, F, G	89.1320	431.00	<b>517.20</b>
1800 x 600mm	1104	3767	450W	A, A+, D, E, F, G	89.1321	503.00	<b>603.60</b>

**Santero Towel Rail - Matt Anthracite**

Size H x W	Watts	BTU	Element Output	Element Type	Code	£ Ex VAT	£ Inc VAT
800 x 500mm	430	1468	150W	A, A+, D, E, F, G	89.1310	241.00	<b>289.20</b>
800 x 600mm	509	1737	150W	A, A+, D, E, F, G	89.1311	283.00	<b>339.60</b>
1200 x 500mm	633	2160	300W	A, A+, D, E, F, G	89.1312	311.00	<b>373.20</b>
1200 x 600mm	749	2556	300W	A, A+, D, E, F, G	89.1313	364.00	<b>436.80</b>
1800 x 500mm	932	3180	450W	A, A+, D, E, F, G	89.1314	431.00	<b>517.20</b>
1800 x 600mm	1104	3767	450W	A, A+, D, E, F, G	89.1315	503.00	<b>603.60</b>

**Santero Towel Rail - Chrome**

Size H x W	Watts	BTU	Element Output	Element Type	Code	£ Ex VAT	£ Inc VAT
800 x 500mm	249	850	150W	A, A+, D, E, F, G	89.1322	324.00	<b>388.80</b>
800 x 600mm	289	987	150W	A, A+, D, E, F, G	89.1323	378.00	<b>453.60</b>
1200 x 500mm	373	1273	150W	A, A+, D, E, F, G	89.1324	392.00	<b>470.40</b>
1200 x 600mm	434	1481	150W	A, A+, D, E, F, G	89.1325	459.00	<b>550.80</b>
1800 x 500mm	551	1881	300W	A, A+, D, E, F, G	89.1326	531.00	<b>637.20</b>
1800 x 600mm	641	2188	300W	A, A+, D, E, F, G	89.1327	622.00	<b>746.40</b>

**TECHNICAL INFORMATION**

All measurements in Height by Width. Heat output based on  $\Delta T60^{\circ}\text{C}$ . Radiators that are electric only are restricted to the heat output of the elements. Element size can be increased to full capacity of rail if using element type D, E, F or G. (Type F & G Elements suitable for all electric only) For element types see pages 288-300. For matching valves see pages 301-309. For indirect heating systems only. Tappings are approx. 45mm less than the width of the rail and approx. 80mm off the wall. Price includes radiator and wall fixing sets, valves extra.

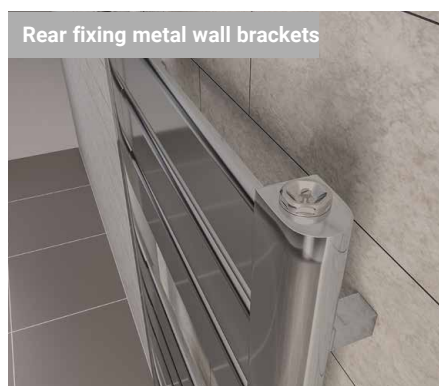
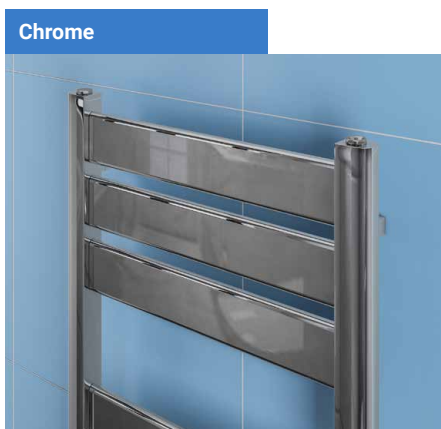
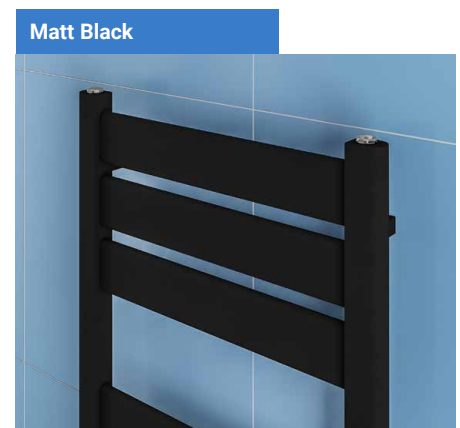

**Radiator Valves**  
Page 301-309



**D Shape Vent Caps**  
Page 313



# Designer Range

## HURLEY

Chrome



**Bar Dimensions (mm)**

Horizontal Bars 40 x 10mm  
Vertical Bars 30 x 30mm

Pictured 89.0568 Chrome

Matt Anthracite

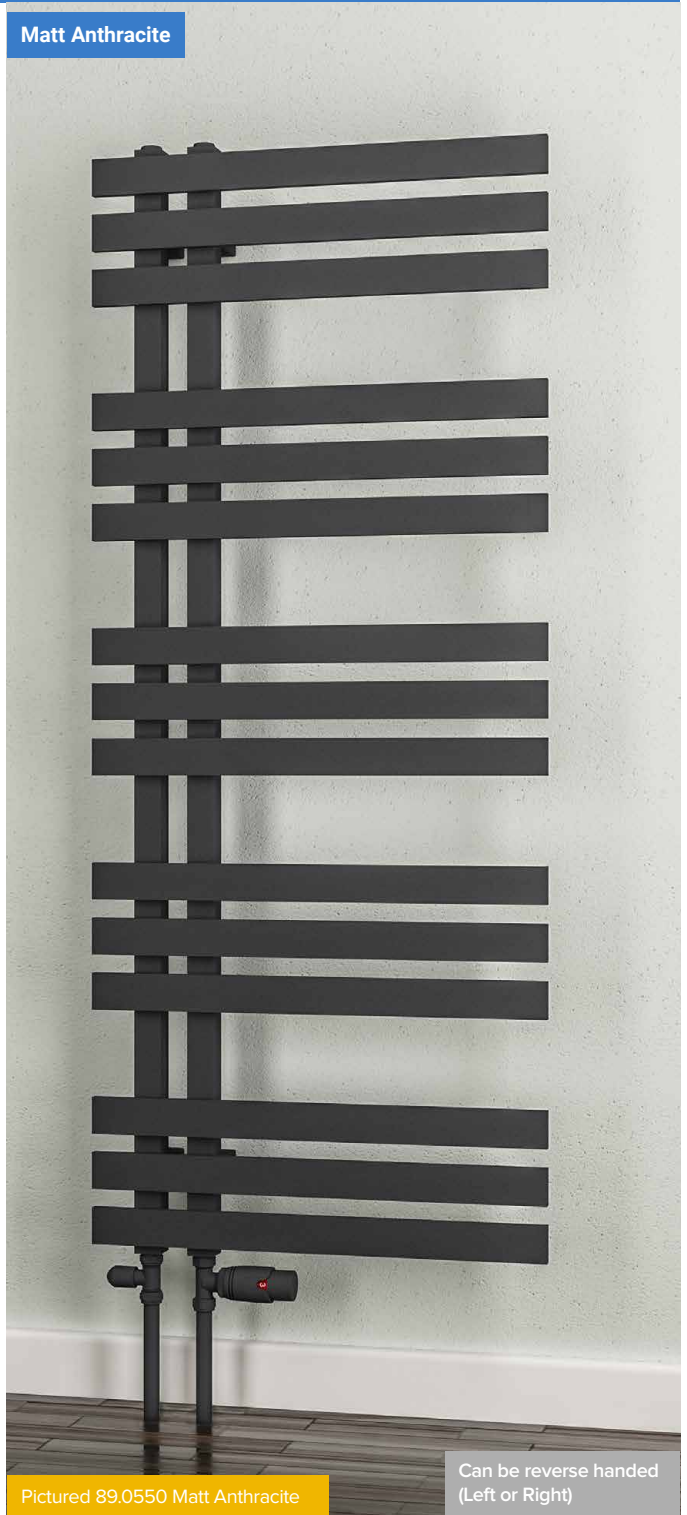

Pictured 89.0550 Matt Anthracite

Can be reverse handed  
(Left or Right)

A modern, versatile towel rail. Available in 6 colours with reversible installation possibility.

**FEATURES**

- 40 x 10mm. horizontal bars and 30 x 30mm. vertical profiles
- Rear fixing metal wall brackets
- Tested to BS EN 442 standards
- 6 colours available from stock
- Can be reverse handed (left or right)
- Can be single, dual fuel or all electric
- 5 Year Manufacturer's Warranty\*
- \* With conditions



Warranty

**5**

Year

Heating

All Electric

Dual-Fuel

# Designer Range

HURLEY

Hurley Towel Rail - Chrome							
Size H x W	Watts	BTU	Element Output	Element Type	Code	£ Ex VAT	£ Inc VAT
800 x 500mm	239	816	150W	A, A+, D, E, F, G	89.0566	327.00	<b>392.40</b>
800 x 600mm	268	915	150W	A, A+, D, E, F, G	89.0567	367.00	<b>440.40</b>
1000 x 500mm	298	1017	100W	A, A+, D, E, F, G	89.1727	395.00	<b>474.00</b>
1000 x 600mm	334	1140	100W	A, A+, D, E, F, G	89.1728	443.00	<b>531.60</b>
1200 x 500mm	356	1215	150W	A, A+, D, E, F, G	89.0568	453.00	<b>543.60</b>
1200 x 600mm	399	1362	150W	A, A+, D, E, F, G	89.0569	507.00	<b>608.40</b>
1500 x 500mm	441	1505	150W	A, A+, D, E, F, G	89.1739	548.00	<b>657.60</b>
1500 x 600mm	494	1686	150W	A, A+, D, E, F, G	89.1740	612.00	<b>734.40</b>
1800 x 500mm	522	1782	300W	A, A+, D, E, F, G	89.0570	626.00	<b>751.20</b>
1800 x 600mm	585	1997	300W	A, A+, D, E, F, G	89.0571	699.00	<b>838.80</b>

Hurley Towel Rail - Matt Anthracite							
Size H x W	Watts	BTU	Element Output	Element Type	Code	£ Ex VAT	£ Inc VAT
800x500mm	368	1256	150W	A, A+, D, E, F, G	89.0548	258.00	<b>309.60</b>
800x600mm	414	1413	150W	A, A+, D, E, F, G	89.0549	291.00	<b>349.20</b>
1000 x 500mm	460	1570	150W	A, A+, D, E, F, G	89.1723	315.00	<b>378.00</b>
1000 x 600mm	517	1765	150W	A, A+, D, E, F, G	89.1724	353.00	<b>423.60</b>
1200x500mm	551	1881	300W	A, A+, D, E, F, G	89.0550	356.00	<b>427.20</b>
1200x600mm	619	2113	300W	A, A+, D, E, F, G	89.0551	398.00	<b>477.60</b>
1500 x 500mm	684	2334	300W	A, A+, D, E, F, G	89.1735	413.00	<b>495.60</b>
1500 x 600mm	768	2621	300W	A, A+, D, E, F, G	89.1736	461.00	<b>553.20</b>
1800x500mm	813	2774	450W	A, A+, D, E, F, G	89.0552	453.00	<b>543.60</b>
1800x600mm	913	3116	450W	A, A+, D, E, F, G	89.0553	507.00	<b>608.40</b>

**Technical Tables & Drawings**  
Page 340-341

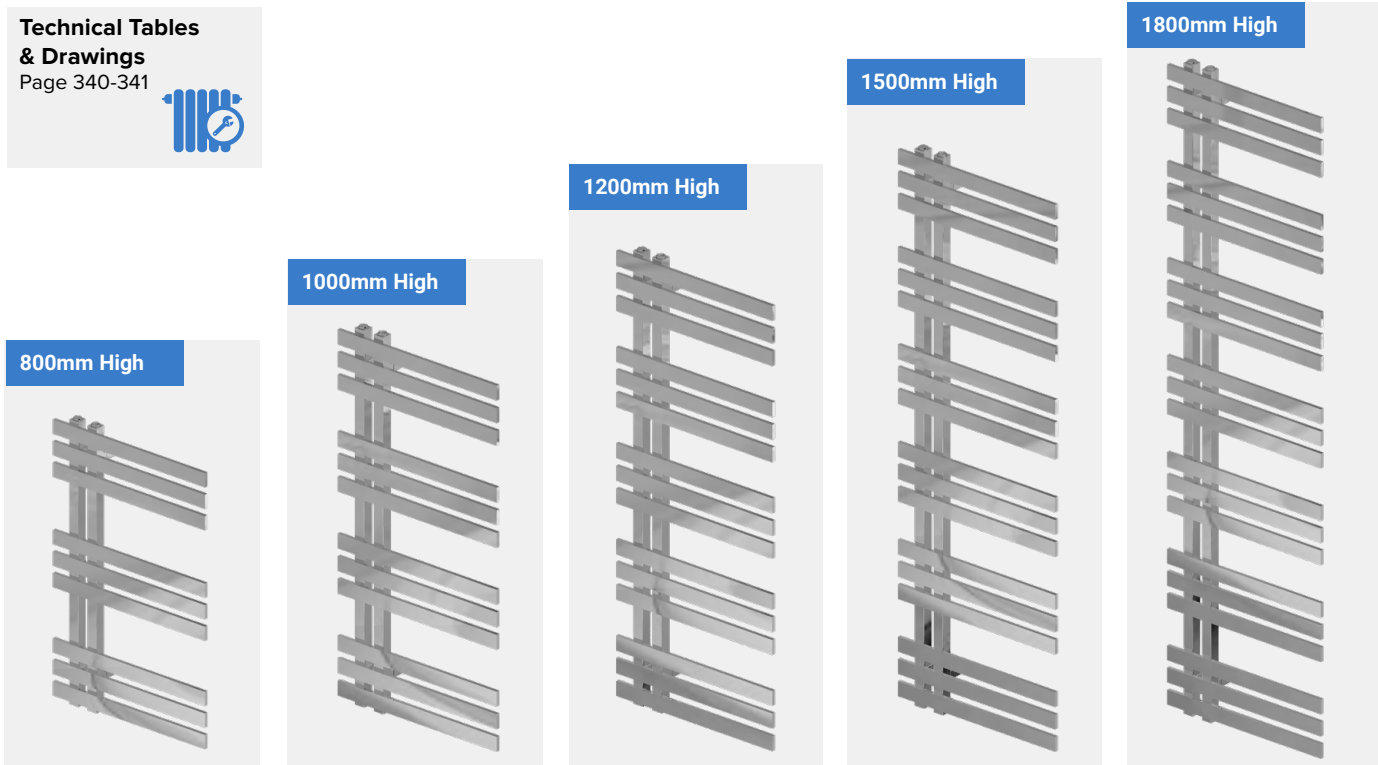
## TECHNICAL INFORMATION

All measurements in Height by Width. Heat output based on  $\blacktriangle T60^{\circ}C$ . Radiators that are electric only are restricted to the heat output of the elements. Element size can be increased to full capacity of rail if using element type D, E, F or G. (Type F & G Elements suitable for all electric only) For element types see pages 288-300. For matching valves see pages 301-309. For indirect heating systems only. Tappings are approx. 60mm and approx. 79mm off the wall. Price includes radiator and wall fixing sets, valves extra.

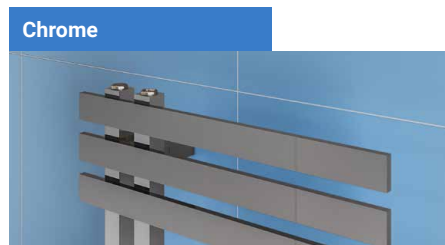
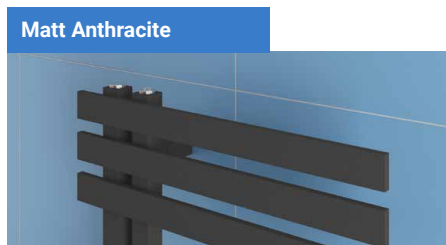
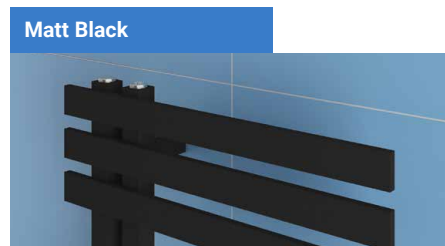
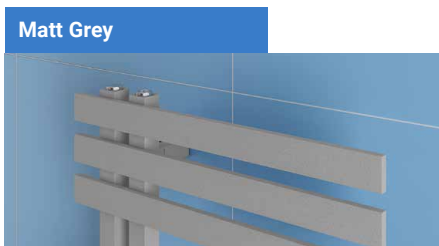
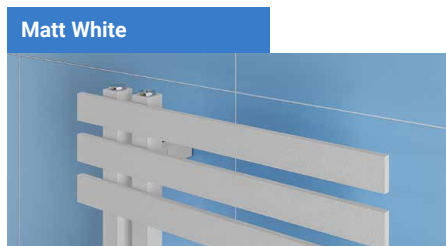

# Designer Range

## HURLEY

Matt Black



Pictured 89.1716 Matt Black

**Bar Dimensions (mm)**

Horizontal Bars 40 x 10mm  
Vertical Bars 30 x 30mm

Matt White



Pictured 89.1729 Matt White

Can be reverse handed  
(Left or Right)

A modern, versatile towel rail. Available in 6 colours with reversible installation possibility.

**FEATURES**

- 40 x 10mm. horizontal bars and 30 x 30mm. vertical profiles
- Rear fixing metal wall brackets
- Tested to BS EN 442 standards
- 6 colours available from stock
- Can be reverse handed (left or right)
- Can be single, dual fuel or all electric
- 5 Year Manufacturer's Warranty\*
- \* With conditions

**Technical Tables  
& Drawings**  
Page 340-341



Warranty  
**5**  
Year

Heating

All Electric

Dual-Fuel

# Designer Range

HURLEY

## Hurley Towel Rail - Matt White

Size H x W	Watts	BTU	Element Output	Element Type	Code	£ Ex VAT	£ Inc VAT
800 x 500mm	368	1256	150W	A, A+, D, E, F, G	89.0542	258.00	<b>309.60</b>
800 x 600mm	414	1413	150W	A, A+, D, E, F, G	89.0543	291.00	<b>349.20</b>
1000 x 500mm	460	1570	150W	A, A+, D, E, F, G	89.1717	315.00	<b>378.00</b>
1000 x 600mm	517	1765	150W	A, A+, D, E, F, G	89.1718	353.00	<b>423.60</b>
1200 x 500mm	551	1881	300W	A, A+, D, E, F, G	89.0544	356.00	<b>427.20</b>
1200 x 600mm	619	2113	300W	A, A+, D, E, F, G	89.0545	398.00	<b>477.60</b>
1500 x 500mm	684	2334	300W	A, A+, D, E, F, G	89.1729	413.00	<b>495.60</b>
1500 x 600mm	768	2621	300W	A, A+, D, E, F, G	89.1730	461.00	<b>553.20</b>
1800 x 500mm	813	2774	450W	A, A+, D, E, F, G	89.0546	453.00	<b>543.60</b>
1800 x 600mm	913	3116	450W	A, A+, D, E, F, G	89.0547	507.00	<b>608.40</b>

## Hurley Towel Rail - Matt Grey

Size H x W	Watts	BTU	Element Output	Element Type	Code	£ Ex VAT	£ Inc VAT
800 x 500mm	368	1256	150W	A, A+, D, E, F, G	89.0554	258.00	<b>309.60</b>
800 x 600mm	414	1413	150W	A, A+, D, E, F, G	89.0555	291.00	<b>349.20</b>
1000 x 500mm	460	1570	150W	A, A+, D, E, F, G	89.1719	315.00	<b>378.00</b>
1000 x 600mm	517	1765	150W	A, A+, D, E, F, G	89.1720	353.00	<b>423.60</b>
1200 x 500mm	551	1881	300W	A, A+, D, E, F, G	89.0556	356.00	<b>427.20</b>
1200 x 600mm	619	2113	300W	A, A+, D, E, F, G	89.0557	398.00	<b>477.60</b>
1500 x 500mm	684	2334	300W	A, A+, D, E, F, G	89.1731	413.00	<b>495.60</b>
1500 x 600mm	768	2621	300W	A, A+, D, E, F, G	89.1732	461.00	<b>553.20</b>
1800 x 500mm	813	2774	450W	A, A+, D, E, F, G	89.0558	453.00	<b>543.60</b>
1800 x 600mm	913	3116	450W	A, A+, D, E, F, G	89.0559	507.00	<b>608.40</b>

## Hurley Towel Rail - Matt Cappuccino

Size H x W	Watts	BTU	Element Output	Element Type	Code	£ Ex VAT	£ Inc VAT
800x500mm	368	1256	150W	A, A+, D, E, F, G	89.0560	284.00	<b>340.80</b>
800x600mm	414	1413	150W	A, A+, D, E, F, G	89.0561	317.00	<b>380.40</b>
1000 x 500mm	460	1570	150W	A, A+, D, E, F, G	89.1721	315.00	<b>378.00</b>
1000 x 600mm	517	1765	150W	A, A+, D, E, F, G	89.1722	353.00	<b>423.60</b>
1200x500mm	551	1881	300W	A, A+, D, E, F, G	89.0562	389.00	<b>466.80</b>
1200x600mm	619	2113	300W	A, A+, D, E, F, G	89.0563	436.00	<b>523.20</b>
1500 x 500mm	684	2334	300W	A, A+, D, E, F, G	89.1733	413.00	<b>495.60</b>
1500 x 600mm	768	2621	300W	A, A+, D, E, F, G	89.1734	461.00	<b>553.20</b>
1800x500mm	813	2774	450W	A, A+, D, E, F, G	89.0564	496.00	<b>595.20</b>
1800x600mm	913	3116	450W	A, A+, D, E, F, G	89.0565	555.00	<b>666.00</b>

## Hurley Towel Rail - Matt Black

Size H x W	Watts	BTU	Element Output	Element Type	Code	£ Ex VAT	£ Inc VAT
800 x 500mm	368	1256	150W	A, A+, D, E, F, G	89.1711	258.00	<b>309.60</b>
800 x 600mm	414	1413	150W	A, A+, D, E, F, G	89.1712	291.00	<b>349.20</b>
1000 x 500mm	460	1570	150W	A, A+, D, E, F, G	89.1725	315.00	<b>378.00</b>
1000 x 600mm	517	1765	150W	A, A+, D, E, F, G	89.1726	353.00	<b>423.60</b>
1200 x 500mm	551	1881	300W	A, A+, D, E, F, G	89.1713	356.00	<b>427.20</b>
1200 x 600mm	619	2113	300W	A, A+, D, E, F, G	89.1714	398.00	<b>477.60</b>
1500 x 500mm	684	2334	300W	A, A+, D, E, F, G	89.1737	413.00	<b>495.60</b>
1500 x 600mm	768	2621	300W	A, A+, D, E, F, G	89.1738	461.00	<b>553.20</b>
1800 x 500mm	813	2774	450W	A, A+, D, E, F, G	89.1715	453.00	<b>543.60</b>
1800 x 600mm	913	3116	450W	A, A+, D, E, F, G	89.1716	507.00	<b>608.40</b>

Matt Grey



Matt Cappuccino



## TECHNICAL INFORMATION

All measurements in Height by Width. Heat output based on  $\Delta T60^{\circ}\text{C}$ . Radiators that are electric only are restricted to the heat output of the elements. Element size can be increased to full capacity of rail if using element type D, E, F or G. (Type F & G Elements suitable for all electric only) For element types see pages 288-300. For matching valves see pages 301-309. For indirect heating systems only. Tappings are approx. 60mm and approx. 79mm off the wall. Price includes radiator and wall fixing sets, valves extra.

# Designer Range

## HELMSLEY



Pictured 89.0637 Matt Anthracite

### Bar Dimensions (mm)

Horizontal Bars 70 x 11mm  
Vertical Bars 30 x 30mm

Warranty  
**5**  
Year

Heating  

All Electric  

Dual-Fuel  

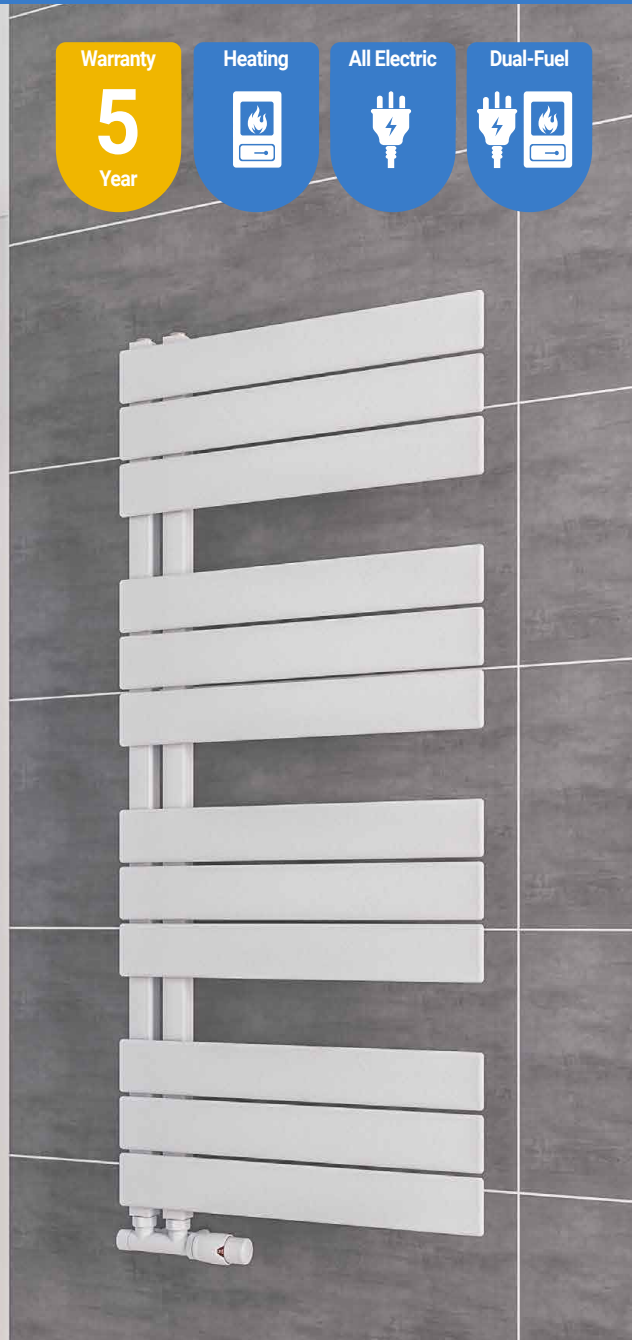
### Technical Tables & Drawings

Page 340-341



Pictured 89.0616 Matt White

Can be reverse handed  
(Left or Right)

One of the most popular models in the Designer Range. Available in a variety of colours to suit any bathroom. The generous surface area of the horizontal bars will let you experience the warmth. Helmsley is also reversible whilst fitting on the wall.

### FEATURES

- 72 x 11mm. horizontal bars and 30 x 30mm. vertical profiles
  - Rear fixing metal wall brackets
  - Tested to BS EN 442 standards
  - 4 colours available from stock
  - Can be reverse handed (left or right)
  - Can be single, dual fuel or all electric
  - State-of-the-Art welding technology
  - 5 Year Manufacturer's Warranty\*
- \* With conditions



**SWATCHES AVAILABLE**

### Round Vent Caps

Page 313





# Designer Range

## HELMSLEY

### Helmsley Towel Rail - Matt White

Size H x W	Watts	BTU	Element Output	Element Type	Code	£ Ex VAT	£ Inc VAT
800 x 500mm	437	1492	300W	A, A+, D, E, F, G	89.0614	284.00	<b>340.80</b>
800 x 600mm	506	1727	300W	A, A+, D, E, F, G	89.0615	314.00	<b>475.20</b>
1150 x 500mm	607	2072	300W	A, A+, D, E, F, G	89.0616	392.00	<b>470.40</b>
1150 x 600mm	703	2399	450W	A, A+, D, E, F, G	89.0617	436.00	<b>523.20</b>
1400 x 500mm	736	2512	450W	A, A+, D, E, F, G	89.0618	426.00	<b>511.20</b>
1400 x 600mm	853	2911	600W	A, A+, D, E, F, G	89.0619	474.00	<b>568.80</b>
1640 x 500mm	869	2966	600W	A, A+, D, E, F, G	89.0620	460.00	<b>552.00</b>
1640 x 600mm	1007	3436	600W	A, A+, D, E, F, G	89.0621	516.00	<b>619.20</b>

### Helmsley Towel Rail - Matt Anthracite

Size H x W	Watts	BTU	Element Output	Element Type	Code	£ Ex VAT	£ Inc VAT
800 x 500mm	437	1492	300W	A, A+, D, E, F, G	89.0630	284.00	<b>340.80</b>
800 x 600mm	506	1727	300W	A, A+, D, E, F, G	89.0631	314.00	<b>376.80</b>
1150 x 500mm	607	2072	300W	A, A+, D, E, F, G	89.0632	392.00	<b>470.40</b>
1150 x 600mm	703	2399	450W	A, A+, D, E, F, G	89.0633	436.00	<b>523.20</b>
1400 x 500mm	736	2512	450W	A, A+, D, E, F, G	89.0634	426.00	<b>511.20</b>
1400 x 600mm	853	2911	600W	A, A+, D, E, F, G	89.0635	474.00	<b>568.80</b>
1640 x 500mm	869	2966	600W	A, A+, D, E, F, G	89.0636	460.00	<b>552.00</b>
1640 x 600mm	1007	3436	600W	A, A+, D, E, F, G	89.0637	516.00	<b>619.20</b>

### Helmsley Towel Rail - Matt Grey

Size H x W	Watts	BTU	Element Output	Element Type	Code	£ Ex VAT	£ Inc VAT
800 x 500mm	437	1492	300W	A, A+, D, E, F, G	89.0622	284.00	<b>340.80</b>
800 x 600mm	506	1727	300W	A, A+, D, E, F, G	89.0623	314.00	<b>376.80</b>
1150 x 500mm	607	2072	300W	A, A+, D, E, F, G	89.0624	392.00	<b>470.40</b>
1150 x 600mm	703	2399	450W	A, A+, D, E, F, G	89.0625	436.00	<b>523.20</b>
1400 x 500mm	736	2512	450W	A, A+, D, E, F, G	89.0626	426.00	<b>511.20</b>
1400 x 600mm	853	2911	600W	A, A+, D, E, F, G	89.0627	474.00	<b>568.80</b>
1640 x 500mm	869	2966	600W	A, A+, D, E, F, G	89.0628	460.00	<b>552.00</b>
1640 x 600mm	1007	3436	600W	A, A+, D, E, F, G	89.0629	516.00	<b>619.20</b>

### Helmsley Towel Rail - Matt Black

Size H x W	Watts	BTU	Element Output	Element Type	Code	£ Ex VAT	£ Inc VAT
800 x 500mm	437	1492	300W	A, A+, D, E, F, G	89.0638	284.00	<b>340.80</b>
800 x 600mm	506	1727	300W	A, A+, D, E, F, G	89.0639	314.00	<b>376.80</b>
1150 x 500mm	607	2072	300W	A, A+, D, E, F, G	89.0640	392.00	<b>470.40</b>
1150 x 600mm	703	2399	450W	A, A+, D, E, F, G	89.0641	436.00	<b>523.20</b>
1400 x 500mm	736	2512	450W	A, A+, D, E, F, G	89.0642	426.00	<b>511.20</b>
1400 x 600mm	853	2911	600W	A, A+, D, E, F, G	89.0643	474.00	<b>568.80</b>
1640 x 500mm	869	2966	600W	A, A+, D, E, F, G	89.0644	460.00	<b>552.00</b>
1640 x 600mm	1007	3436	600W	A, A+, D, E, F, G	89.0645	516.00	<b>619.20</b>

### TECHNICAL INFORMATION

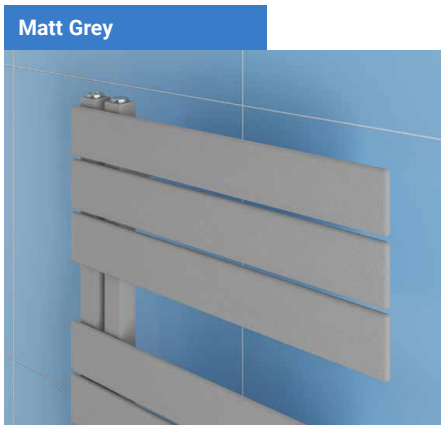

All measurements in Height by Width. Heat output based on ▲T60°C. Radiators that are electric only are restricted to the heat output of the elements. Element size can be increased to full capacity of rail if using element type D, E, F or G. (Type F & G Elements suitable for all electric only) For element types see pages 288-300. For matching valves see pages 301-309. For indirect heating systems only. Tappings are approx. 50mm and approx. 79mm off the wall. Price includes radiator and wall fixing sets, valves extra.



**Radiator Valves**  
Page 301-309

# Designer Range

## PLATANI

<p>Warranty</p> <p><b>5</b></p> <p>Year</p>	<p>Heating</p> 	<p>All Electric</p> 	<p>Dual-Fuel</p> 
---	--	---	--



**Technical Tables & Drawings**  
Page 340-341



Pictured 89.1355 Chrome

**Bar Dimensions (mm)**

Horizontal Bars 40 x 20mm  
Vertical Bars 30 x 30mm



Pictured 89.1344 Matt Anthracite

Can be reverse handed (Left or Right)

A stunning reversible style towel rail with evenly spaced horizontal bars. Available in 5 colours from stock including high quality chrome finish.

**FEATURES**

- 40 x 20mm. horizontal bars and 30 x 30mm. vertical profiles
- Rear fixing metal wall brackets
- Tested to BS EN 442 standards
- 5 colours available from stock
- Can be reverse handed (left or right)
- Can be single, dual fuel or all electric
- State-of-the-Art welding technology
- 5 Year Manufacturer's Warranty\*
- \* With conditions



**Round Vent Caps**  
Page 313



# Designer Range

## PLATANI

### Platani Towel Rail - Matt White

Size H x W	Watts	BTU	Element Output	Element Type	Code	£ Ex VAT	£ Inc VAT
800 x 500mm	339	1157	150W	A, A+, D, E, F, G	89.1328	207.00	<b>248.40</b>
800 x 600mm	389	1328	150W	A, A+, D, E, F, G	89.1329	231.00	<b>277.20</b>
1150 x 500mm	467	1594	150W	A, A+, D, E, F, G	89.1330	285.00	<b>342.00</b>
1150 x 600mm	535	1826	150W	A, A+, D, E, F, G	89.1331	321.00	<b>385.20</b>
1800 x 500mm	703	2399	300W	A, A+, D, E, F, G	89.1332	361.00	<b>433.20</b>
1800 x 600mm	806	2751	300W	A, A+, D, E, F, G	89.1333	404.00	<b>484.80</b>

### Platani Towel Rail - Matt Anthracite

Size H x W	Watts	BTU	Element Output	Element Type	Code	£ Ex VAT	£ Inc VAT
800 x 500mm	339	1157	150W	A, A+, D, E, F, G	89.1340	207.00	<b>248.40</b>
800 x 600mm	389	1328	150W	A, A+, D, E, F, G	89.1341	231.00	<b>277.20</b>
1150 x 500mm	467	1594	150W	A, A+, D, E, F, G	89.1342	285.00	<b>342.00</b>
1150 x 600mm	535	1826	150W	A, A+, D, E, F, G	89.1343	321.00	<b>385.20</b>
1800 x 500mm	703	2399	300W	A, A+, D, E, F, G	89.1344	361.00	<b>433.20</b>
1800 x 600mm	806	2751	300W	A, A+, D, E, F, G	89.1345	404.00	<b>484.80</b>

### Platani Towel Rail - Matt Grey

Size H x W	Watts	BTU	Element Output	Element Type	Code	£ Ex VAT	£ Inc VAT
800 x 500mm	339	1157	150W	A, A+, D, E, F, G	89.1334	207.00	<b>248.40</b>
800 x 600mm	389	1328	150W	A, A+, D, E, F, G	89.1335	231.00	<b>277.20</b>
1150 x 500mm	467	1594	150W	A, A+, D, E, F, G	89.1336	285.00	<b>342.00</b>
1150 x 600mm	535	1826	150W	A, A+, D, E, F, G	89.1337	321.00	<b>385.20</b>
1800 x 500mm	703	2399	300W	A, A+, D, E, F, G	89.1338	361.00	<b>433.20</b>
1800 x 600mm	806	2751	300W	A, A+, D, E, F, G	89.1339	404.00	<b>484.80</b>

### Platani Towel Rail - Matt Black

Size H x W	Watts	BTU	Element Output	Element Type	Code	£ Ex VAT	£ Inc VAT
800 x 500mm	339	1157	150W	A, A+, D, E, F, G	89.1346	207.00	<b>248.40</b>
800 x 600mm	389	1328	150W	A, A+, D, E, F, G	89.1347	231.00	<b>277.20</b>
1150 x 500mm	467	1594	150W	A, A+, D, E, F, G	89.1348	285.00	<b>342.00</b>
1150 x 600mm	535	1826	150W	A, A+, D, E, F, G	89.1349	321.00	<b>385.20</b>
1800 x 500mm	703	2399	300W	A, A+, D, E, F, G	89.1350	361.00	<b>433.20</b>
1800 x 600mm	806	2751	300W	A, A+, D, E, F, G	89.1351	404.00	<b>484.80</b>

### Platani Towel Rail - Chrome

Size H x W	Watts	BTU	Element Output	Element Type	Code	£ Ex VAT	£ Inc VAT
800 x 500mm	216	737	100W	A, A+, D, E, F, G	89.1352	264.00	<b>316.80</b>
800 x 600mm	247	843	100W	A, A+, D, E, F, G	89.1353	297.00	<b>356.40</b>
1150 x 500mm	299	1021	150W	A, A+, D, E, F, G	89.1354	364.00	<b>436.80</b>
1150 x 600mm	342	1167	150W	A, A+, D, E, F, G	89.1355	409.00	<b>490.80</b>
1800 x 500mm	455	1553	150W	A, A+, D, E, F, G	89.1356	507.00	<b>608.40</b>
1800 x 600mm	520	1775	150W	A, A+, D, E, F, G	89.1357	566.00	<b>679.20</b>

### Radiator Valves

Page 301-309



### TECHNICAL INFORMATION

All measurements in Height by Width. Heat output based on  $\Delta T60^{\circ}C$ . Radiators that are electric only are restricted to the heat output of the elements. Element size can be increased to full capacity of rail if using element type D, E, F or G. (Type F & G Elements suitable for all electric only) For element types see pages 288-300. For matching valves see pages 301-309. For indirect heating systems only. Tappings are approx. 50mm and approx. 80mm off the wall. Projection from wall is 115mm. Price includes radiator and wall fixing sets, valves extra.



# Designer Range

## REINBACH



Pictured 89.1363 Matt White

### Bar Dimensions (mm)

Horizontal Bars 30 x 30mm  
Vertical Bars 30 x 30mm

Warranty  
**5**  
Year

Heating

All Electric

Dual-Fuel



Technical Tables  
& Drawings  
Page 340-341



Pictured 89.1384 Matt Black

Can be reverse handed  
(Left or Right)

Another reversible style design, Reinbach reaches the top levels of design with bulky horizontal bars that are capable of drying your largest towels.

### FEATURES

- 30 x 30mm. horizontal bars and 30 x 30mm. vertical profiles
  - Rear fixing metal wall brackets
  - Tested to BS EN 442 standards
  - 5 colours available from stock
  - Can be reverse handed (left or right)
  - Can be single, dual fuel or all electric
  - State-of-the-Art welding technology
  - 5 Year Manufacturer's Warranty\*
- \* With conditions



SWATCHES AVAILABLE

Round Vent Caps  
Page 313



# Designer Range

REINBACH

### Reinbach Towel Rail - Matt White

Size H x W	Watts	BTU	Element Output	Element Type	Code	£ Ex VAT	£ Inc VAT
800 x 500mm	466	1590	150W	A, A+, D, E, F, G	89.1358	246.00	295.20
800 x 600mm	556	1898	300W	A, A+, D, E, F, G	89.1359	273.00	327.60
1200 x 500mm	671	2290	300W	A, A+, D, E, F, G	89.1360	335.00	402.00
1200 x 600mm	802	2737	300W	A, A+, D, E, F, G	89.1361	377.00	452.40
1800 x 500mm	976	3331	450W	A, A+, D, E, F, G	89.1362	431.00	517.20
1800 x 600mm	1166	3979	600W	A, A+, D, E, F, G	89.1363	480.00	576.00

### Reinbach Towel Rail - Matt Grey

Size H x W	Watts	BTU	Element Output	Element Type	Code	£ Ex VAT	£ Inc VAT
800 x 500mm	466	1590	150W	A, A+, D, E, F, G	89.1370	246.00	295.20
800 x 600mm	556	1898	300W	A, A+, D, E, F, G	89.1371	273.00	327.60
1200 x 500mm	671	2290	300W	A, A+, D, E, F, G	89.1372	335.00	402.00
1200 x 600mm	802	2737	300W	A, A+, D, E, F, G	89.1373	377.00	452.40
1800 x 500mm	976	3331	450W	A, A+, D, E, F, G	89.1374	431.00	517.20
1800 x 600mm	1166	3979	600W	A, A+, D, E, F, G	89.1375	480.00	576.00

### Reinbach Towel Rail - Matt Cappuccino

Size H x W	Watts	BTU	Element Output	Element Type	Code	£ Ex VAT	£ Inc VAT
800 x 500mm	466	1590	150W	A, A+, D, E, F, G	89.1364	246.00	295.20
800 x 600mm	556	1898	300W	A, A+, D, E, F, G	89.1365	273.00	327.60
1200 x 500mm	671	2290	300W	A, A+, D, E, F, G	89.1366	335.00	402.00
1200 x 600mm	802	2737	300W	A, A+, D, E, F, G	89.1367	377.00	452.40
1800 x 500mm	976	3331	450W	A, A+, D, E, F, G	89.1368	431.00	517.20
1800 x 600mm	1166	3979	600W	A, A+, D, E, F, G	89.1369	480.00	576.00

### Reinbach Towel Rail - Matt Anthracite

Size H x W	Watts	BTU	Element Output	Element Type	Code	£ Ex VAT	£ Inc VAT
800 x 500mm	466	1590	150W	A, A+, D, E, F, G	89.1376	246.00	295.20
800 x 600mm	556	1898	300W	A, A+, D, E, F, G	89.1377	273.00	327.60
1200 x 500mm	671	2290	300W	A, A+, D, E, F, G	89.1378	335.00	402.00
1200 x 600mm	802	2737	300W	A, A+, D, E, F, G	89.1379	377.00	452.40
1800 x 500mm	976	3331	450W	A, A+, D, E, F, G	89.1380	431.00	517.20
1800 x 600mm	1166	3979	600W	A, A+, D, E, F, G	89.1381	480.00	576.00

### Reinbach Towel Rail - Matt Black

Size H x W	Watts	BTU	Element Output	Element Type	Code	£ Ex VAT	£ Inc VAT
800 x 500mm	466	1590	150W	A, A+, D, E, F, G	89.1382	246.00	295.20
800 x 600mm	556	1898	300W	A, A+, D, E, F, G	89.1383	273.00	327.60
1200 x 500mm	671	2290	300W	A, A+, D, E, F, G	89.1384	335.00	402.00
1200 x 600mm	802	2737	300W	A, A+, D, E, F, G	89.1385	377.00	452.40
1800 x 500mm	976	3331	450W	A, A+, D, E, F, G	89.1386	431.00	517.20
1800 x 600mm	1166	3979	600W	A, A+, D, E, F, G	89.1387	480.00	576.00

### Radiator Valves

Page 301-309



### TECHNICAL INFORMATION

All measurements in Height by Width. Heat output based on  $\Delta T60^{\circ}C$ . Radiators that are electric only are restricted to the heat output of the elements. Element size can be increased to full capacity of rail if using element type D, E, F or G. (Type F & G Elements suitable for all electric only) For element types see pages 288-300. For matching valves see pages 301-309. For indirect heating systems only. Tappings are approx. 50mm and approx. 80mm off the wall. Projection from wall is 125mm. Price includes radiator and wall fixing sets, valves extra.

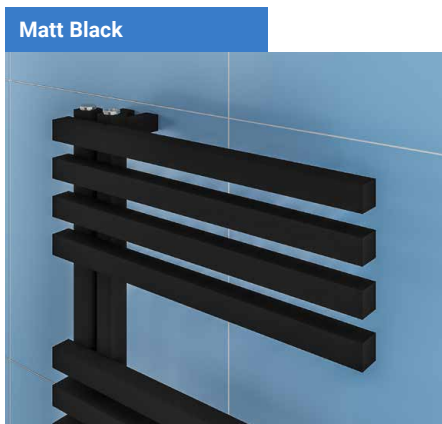

# Designer Range

## MARLOW

Warranty  
**5**  
Year

Diameter (Ø)  
**42**  
MM Bars

Heating  



**Technical Tables  
& Drawings**  
Page 342-343



Pictured 89.0526 Chrome



Pictured 89.0516 Matt Grey

Rear fixing metal wall brackets

State-of-the-Art welding meets large vertical and horizontal tubes in this model. Available in a variety of colours to suit any bathroom. The generous spacing between the horizontal tubes allows for maximum towel drying.

### FEATURES

- 42mm diameter horizontal bars
  - 42mm diameter vertical profiles
  - Rear fixing metal wall brackets
  - Tested to BS EN 442 standards
  - 5 colours available from stock
  - State-of-the-Art welding technology
  - 5 Year Manufacturer's Warranty\*
- \* With conditions



### Round Vent Caps

Page 313

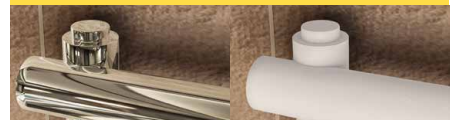

# Designer Range

## MARLOW

### Marlow Towel Rail - Matt White

Size H x W	Watts	BTU	Element Output	Element Type	Code	£ Ex VAT	£ Inc VAT
850 x 500mm	399	1362	N/A	N/A	89.0500	372.00	<b>446.40</b>
850 x 600mm	452	1543	N/A	N/A	89.0501	396.00	<b>475.20</b>
1150 x 500mm	534	1823	N/A	N/A	89.0502	459.00	<b>550.80</b>
1150 x 600mm	606	2068	N/A	N/A	89.0503	486.00	<b>583.20</b>
1750 x 500mm	804	2744	N/A	N/A	89.0504	607.00	<b>728.40</b>
1750 x 600mm	912	3112	N/A	N/A	89.0505	643.00	<b>771.60</b>

### Marlow Towel Rail - Matt Grey

Size H x W	Watts	BTU	Element Output	Element Type	Code	£ Ex VAT	£ Inc VAT
850 x 500mm	399	1362	N/A	N/A	89.0512	372.00	<b>446.40</b>
850 x 600mm	452	1543	N/A	N/A	89.0513	396.00	<b>475.20</b>
1150 x 500mm	534	1823	N/A	N/A	89.0514	459.00	<b>550.80</b>
1150 x 600mm	606	2068	N/A	N/A	89.0515	486.00	<b>583.20</b>
1750 x 500mm	804	2744	N/A	N/A	89.0516	607.00	<b>728.40</b>
1750 x 600mm	912	3112	N/A	N/A	89.0517	643.00	<b>771.60</b>

### Marlow Towel Rail - Chrome

Size H x W	Watts	BTU	Element Output	Element Type	Code	£ Ex VAT	£ Inc VAT
850 x 500mm	257	877	N/A	N/A	89.0524	516.00	<b>619.20</b>
850 x 600mm	293	1000	N/A	N/A	89.0525	546.00	<b>655.20</b>
1150 x 500mm	344	1174	N/A	N/A	89.0526	636.00	<b>763.20</b>
1150 x 600mm	392	1338	N/A	N/A	89.0527	675.00	<b>810.00</b>
1750 x 500mm	520	1775	N/A	N/A	89.0528	843.00	<b>1011.60</b>
1750 x 600mm	594	2027	N/A	N/A	89.0529	893.00	<b>1071.60</b>

### Marlow Towel Rail - Matt Anthracite

Size H x W	Watts	BTU	Element Output	Element Type	Code	£ Ex VAT	£ Inc VAT
850 x 500mm	399	1362	N/A	N/A	89.0506	372.00	<b>446.40</b>
850 x 600mm	452	1543	N/A	N/A	89.0507	396.00	<b>475.20</b>
1150 x 500mm	534	1823	N/A	N/A	89.0508	459.00	<b>550.80</b>
1150 x 600mm	606	2068	N/A	N/A	89.0509	486.00	<b>583.20</b>
1750 x 500mm	804	2744	N/A	N/A	89.0510	607.00	<b>728.40</b>
1750 x 600mm	912	3112	N/A	N/A	89.0511	643.00	<b>771.60</b>

### Marlow Towel Rail - Matt Cappuccino

Size H x W	Watts	BTU	Element Output	Element Type	Code	£ Ex VAT	£ Inc VAT
850 x 500mm	399	1362	N/A	N/A	89.0518	409.00	<b>490.80</b>
850 x 600mm	452	1543	N/A	N/A	89.0519	434.00	<b>520.80</b>
1150 x 500mm	534	1823	N/A	N/A	89.0520	506.00	<b>607.20</b>
1150 x 600mm	606	2068	N/A	N/A	89.0521	534.00	<b>640.80</b>
1750 x 500mm	804	2744	N/A	N/A	89.0522	669.00	<b>802.80</b>
1750 x 600mm	912	3112	N/A	N/A	89.0523	710.00	<b>852.00</b>

### Radiator Valves

Page 301-309



### TECHNICAL INFORMATION

All measurements in Height by Width. Heat output based on  $\Delta T60^{\circ}\text{C}$ . **Not suitable for elements.** For matching valves see pages 301-309. For indirect heating systems only. Tappings are approx. 82mm less than the width of the rail and approx. 85mm off the wall. Price includes radiator and wall fixing sets, valves extra.

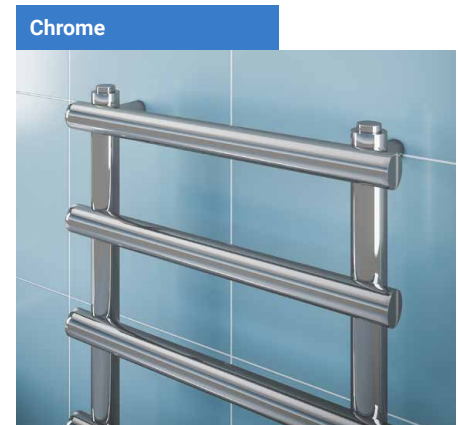

# Designer Range

## MARLOW E-STYLE

Warranty

**5**

Year

Diameter (Ø)

**42**

MM Bars

Heating

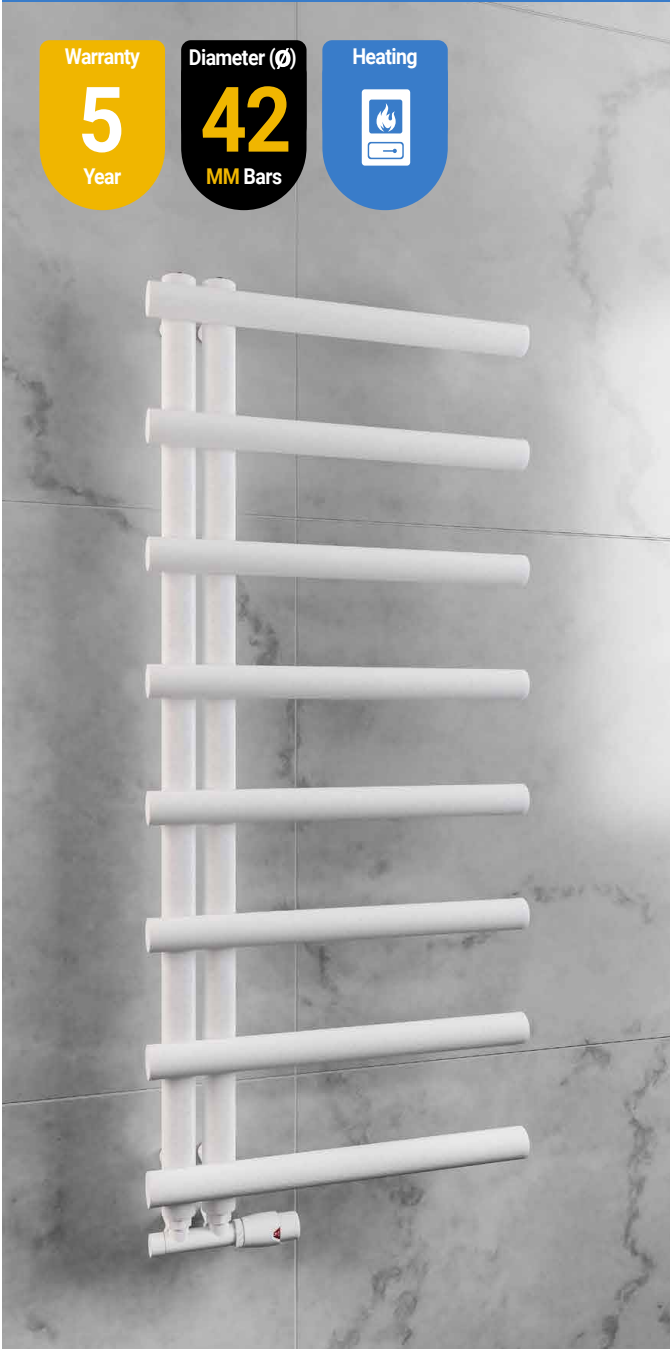

### Technical Tables & Drawings

Page 342-343



Pictured 89.0809 Matt White

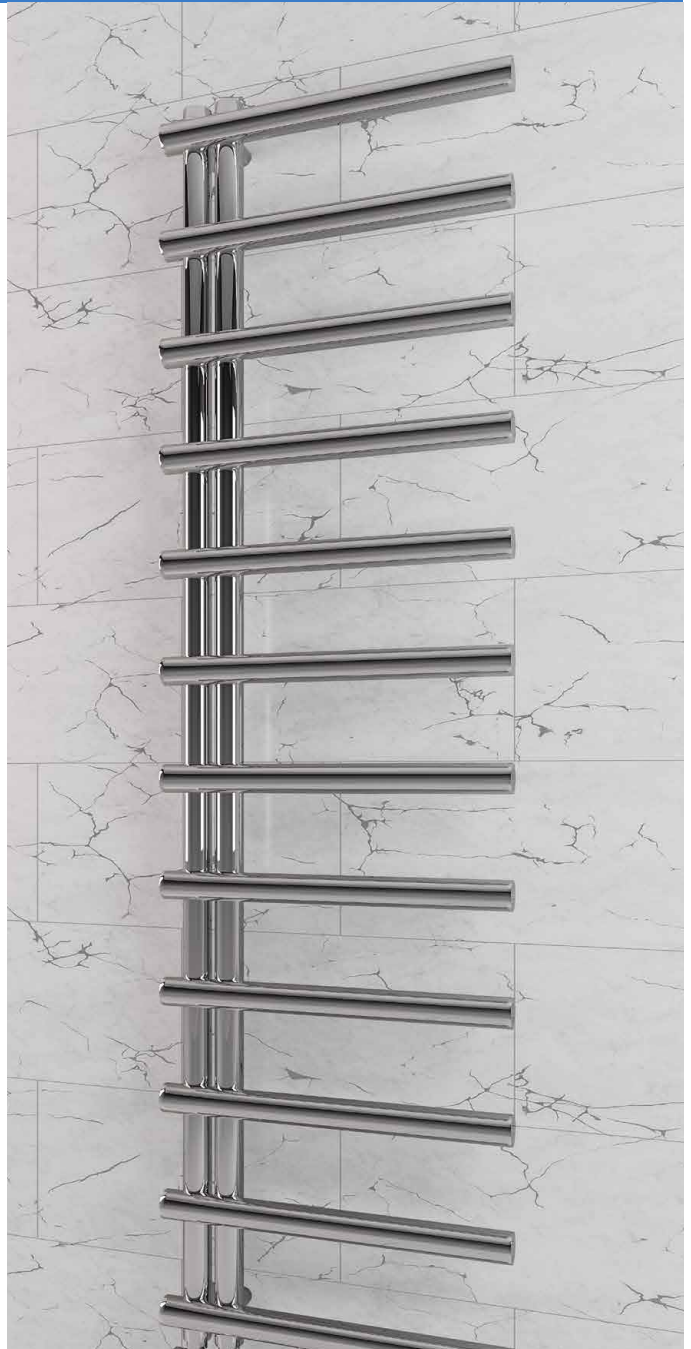

Pictured 89.0835 Chrome

Can be reverse handed (Left or Right)

State-of-the-Art welding meets large vertical and horizontal tubes in this model. Available in a variety of colours to suit any bathroom. The generous spacing between the horizontal tubes allows for maximum towel drying.

### FEATURES

- 42mm diameter horizontal bars
  - 42mm diameter vertical profiles
  - Rear fixing metal wall brackets
  - Tested to BS EN 442 standards
  - 5 colours available from stock
  - Can be reverse handed (left or right)
  - State-of-the-Art welding technology
  - 5 Year Manufacturer's Warranty\*
- \* With conditions



SWATCHES AVAILABLE

### Round Vent Caps

Page 313





# Designer Range

## MARLOW E-STYLE

### Marlow E-Style Towel Rail - Matt White

Size H x W	Watts	BTU	Element Output	Element Type	Code	£ Ex VAT	£ Inc VAT
850 x 500mm	371	1266	N/A	N/A	89.0807	271.00	<b>325.20</b>
850 x 600mm	422	1440	N/A	N/A	89.0808	304.00	<b>364.80</b>
1150 x 500mm	497	1696	N/A	N/A	89.0809	373.00	<b>447.60</b>
1150 x 600mm	566	1932	N/A	N/A	89.0810	416.00	<b>499.20</b>
1750 x 500mm	756	2580	N/A	N/A	89.0811	476.00	<b>571.20</b>
1750 x 600mm	861	2938	N/A	N/A	89.0812	531.00	<b>637.20</b>

### Marlow E-Style Towel Rail - Matt Anthracite

Size H x W	Watts	BTU	Element Output	Element Type	Code	£ Ex VAT	£ Inc VAT
850 x 500mm	371	1266	N/A	N/A	89.0813	271.00	<b>325.20</b>
850 x 600mm	422	1440	N/A	N/A	89.0814	304.00	<b>364.80</b>
1150 x 500mm	497	1696	N/A	N/A	89.0815	373.00	<b>447.60</b>
1150 x 600mm	566	1932	N/A	N/A	89.0816	416.00	<b>499.20</b>
1750 x 500mm	756	2580	N/A	N/A	89.0817	476.00	<b>571.20</b>
1750 x 600mm	861	2938	N/A	N/A	89.0818	531.00	<b>637.20</b>

### Marlow E-Style Towel Rail - Matt Grey

Size H x W	Watts	BTU	Element Output	Element Type	Code	£ Ex VAT	£ Inc VAT
850 x 500mm	371	1266	N/A	N/A	89.0819	271.00	<b>325.20</b>
850 x 600mm	422	1440	N/A	N/A	89.0820	304.00	<b>364.80</b>
1150 x 500mm	497	1696	N/A	N/A	89.0821	373.00	<b>447.60</b>
1150 x 600mm	566	1932	N/A	N/A	89.0822	416.00	<b>499.20</b>
1750 x 500mm	756	2580	N/A	N/A	89.0823	476.00	<b>571.20</b>
1750 x 600mm	861	2938	N/A	N/A	89.0824	531.00	<b>637.20</b>

### Marlow E-Style Towel Rail - Matt Cappuccino

Size H x W	Watts	BTU	Element Output	Element Type	Code	£ Ex VAT	£ Inc VAT
850 x 500mm	371	1266	N/A	N/A	89.0825	271.00	<b>325.20</b>
850 x 600mm	422	1440	N/A	N/A	89.0826	304.00	<b>364.80</b>
1150 x 500mm	497	1696	N/A	N/A	89.0827	373.00	<b>447.60</b>
1150 x 600mm	566	1932	N/A	N/A	89.0828	416.00	<b>499.20</b>
1750 x 500mm	756	2580	N/A	N/A	89.0829	476.00	<b>571.20</b>
1750 x 600mm	861	2938	N/A	N/A	89.0830	531.00	<b>637.20</b>

### Marlow E-Style Towel Rail - Chrome

Size H x W	Watts	BTU	Element Output	Element Type	Code	£ Ex VAT	£ Inc VAT
850 x 500mm	242	826	N/A	N/A	89.0831	345.00	<b>414.00</b>
850 x 600mm	274	935	N/A	N/A	89.0832	386.00	<b>463.20</b>
1150 x 500mm	325	1109	N/A	N/A	89.0833	476.00	<b>571.20</b>
1150 x 600mm	368	1256	N/A	N/A	89.0834	531.00	<b>637.20</b>
1750 x 500mm	491	1676	N/A	N/A	89.0835	659.00	<b>790.80</b>
1750 x 600mm	555	1894	N/A	N/A	89.0836	739.00	<b>886.80</b>

### Twin TRV's Page 304

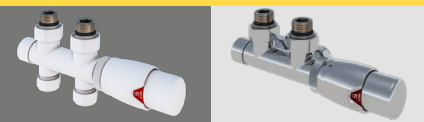

Tappings: 50mm

### TECHNICAL INFORMATION

All measurements in Height by Width. Heat output based on  $\Delta T60^{\circ}C$ . **Not suitable for elements.** For matching valves see pages 301-309. For indirect heating systems only. Tappings are 50mm and approx. 85mm off the wall. Price includes radiator and wall fixing sets, valves extra.

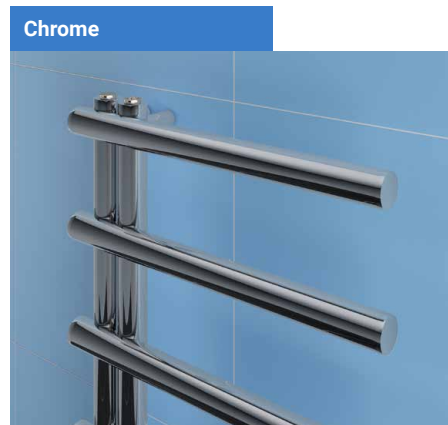

# Designer Range

CONWY

Due in November 2023

Bar Dimensions (mm)

Vertical Bars 40 x 40mm

Technical Tables  
& Drawings  
Page 332-333



Warranty

5  
Year



Pictured 41.0712 Matt Anthracite



Pictured 41.0714 Chrome

A masterpiece for your bathroom or any other room. The square vertical bars at the top can be used as towel / bathrobe hangers and the 3 x robe hooks can be used to dry your towels too. This exceptional design is available in 4 colour options.

**Conwy Vertical Radiator - Matt White**

Size H x W	Watts	BTU	Element Output	Element Type	Code	£ Ex VAT	£ Inc VAT
1200 x 220mm	244	833	100W	A, A+, D, E, F, G	41.0711	144.00	172.80

**Conwy Vertical Radiator - Matt Black**

Size H x W	Watts	BTU	Element Output	Element Type	Code	£ Ex VAT	£ Inc VAT
1200 x 220mm	244	833	100W	A, A+, D, E, F, G	41.0713	144.00	172.80

**Conwy Vertical Radiator - Matt Anthracite**

Size H x W	Watts	BTU	Element Output	Element Type	Code	£ Ex VAT	£ Inc VAT
1200 x 220mm	244	833	100W	A, A+, D, E, F, G	41.0712	144.00	172.80

**Conwy Vertical Radiator - Chrome**

Size H x W	Watts	BTU	Element Output	Element Type	Code	£ Ex VAT	£ Inc VAT
1200 x 220mm	192	655	100W	A, A+, D, E, F, G	41.0714	197.00	236.40

**FEATURES**

- 40 x 40mm vertical profiles
- Comes with pre-fitted 3 x robe hooks
- Rear fixing metal wall brackets
- Tested to BS EN 442 standards
- State-of-the-Art welding technology
- 5 Year Manufacturer's Warranty\*
- \*With conditions

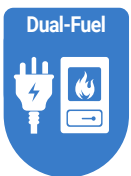

**TECHNICAL INFORMATION**

All measurements in Height by Width. Heat output based on  $\Delta T_{60}^{\circ}\text{C}$ . Radiators that are electric only are restricted to the heat output of the elements. Element size can be increased to full capacity of rail if using element type D, E, F or G. (Type F & G Elements suitable for all electric only) For element types see pages 288-300. For matching valves see pages 301-309. For indirect heating systems only. Tappings are 180mm and approx. 64-74mm off the wall. Tappings height difference 100mm. Projection from wall is 84-94mm. Price includes radiator and wall fixing sets, valves extra.

Matt White



Matt Anthracite



Matt Black



Chrome

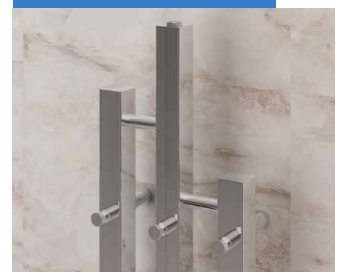

# Designer Range

## PORTCHESTER

Due in November 2023

Bar Dimensions (mm)  
Vertical Bars Diameter 45mm

Warranty  
**5**  
Year

Technical Tables  
& Drawings  
Page 332-333



Pictured 41.0715 Matt White



Pictured 41.0718 Chrome

A masterpiece for your bathroom or any other room. The round vertical bars at the top can be used as towel / bathrobe hangers and the 3 x robe hooks can be used to dry your towels too. This exceptional design is available in 4 colour options.

### Portchester Vertical Radiator - Matt White

Size H x W	Watts	BTU	Element Output	Element Type	Code	£ Ex VAT	£ Inc VAT
1200 x 225mm	275	938	100W	A, A+, D, E, F, G	41.0715	132.00	158.40

### Portchester Vertical Radiator - Matt Black

Size H x W	Watts	BTU	Element Output	Element Type	Code	£ Ex VAT	£ Inc VAT
1200 x 225mm	275	938	100W	A, A+, D, E, F, G	41.0717	132.00	158.40

### Portchester Vertical Radiator - Matt Anthracite

Size H x W	Watts	BTU	Element Output	Element Type	Code	£ Ex VAT	£ Inc VAT
1200 x 225mm	275	938	100W	A, A+, D, E, F, G	41.0716	132.00	158.40

### Portchester Vertical Radiator - Chrome

Size H x W	Watts	BTU	Element Output	Element Type	Code	£ Ex VAT	£ Inc VAT
1200 x 225mm	219	747	100W	A, A+, D, E, F, G	41.0718	181.00	217.20

#### FEATURES

- 45mm diameter vertical profiles
- Comes with pre-fitted 3 x robe hooks
- Rear fixing metal wall brackets
- Tested to BS EN 442 standards
- State-of-the-Art welding technology
- 5 Year Manufacturer's Warranty\*
- \*With conditions

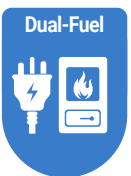

#### TECHNICAL INFORMATION

All measurements in Height by Width. Heat output based on  $\Delta T60^{\circ}C$ . Radiators that are electric only are restricted to the heat output of the elements. Element size can be increased to full capacity of rail if using element type D, E, F or G. (Type F & G Elements suitable for all electric only) For element types see pages 288-300. For matching valves see pages 301-309. For indirect heating systems only. Tappings are 180mm and approx. 67-77mm off the wall. Tappings height difference 100mm. Projection from wall is 89-99mm. Price includes radiator and wall fixing sets, valves extra.

#### Matt White

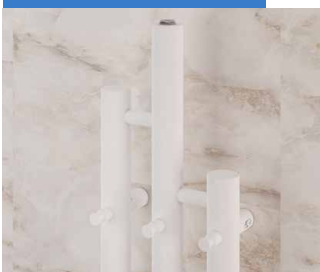

#### Matt Anthracite



#### Matt Black

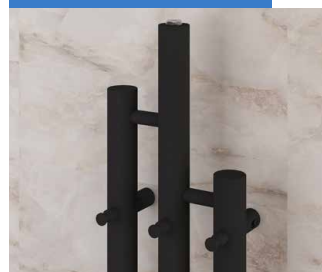

#### Chrome



# Designer Range

## LAMBOURNE

Warranty

# 5

  
Year

Heating



All Electric



Dual-Fuel



Technical Tables  
& Drawings  
Page 342-343



Pictured 89.1701 Chrome (side connection valves shown)

Side or Bottom connections

Rear fixing metal wall brackets

A masterpiece for your bathroom or any other room. The vertical bars at the ends can be used as towel / bathrobe hangers, middle section at the top can be used to dry your towels too. This exceptional design is available in 2 heights and 2 widths with 4 colour options.

### FEATURES

- 42mm diameter horizontal bars
  - 42mm diameter vertical profiles
  - Rear fixing metal wall brackets
  - Tested to BS EN 442 standards
  - State-of-the-Art welding technology
  - Can have either side or bottom connections
  - 4 colours available from stock
  - 5 Year Manufacturer's Warranty\*
- \*With conditions

### TECHNICAL INFORMATION

All measurements in Height by Width. Heat output based on  $\Delta T60^{\circ}\text{C}$ . Radiators that are electric only are restricted to the heat output of the elements. Element size can be increased to full capacity of rail if using element type D, E, F or G. (Type F & G Elements suitable for all electric only) For element types see pages 288-300. For matching valves see pages 301-309. For indirect heating systems only. **For side connection**, tappings are the width of the rail and approx. 85mm off the wall. **For bottom connection**, tappings are approx. 180mm less than the width of the rail and approx. 106mm off the wall. Projection from wall 127mm. Price includes radiator and wall fixing sets, valves extra.

# Designer Range

LAMBOURNE

### Lambourne Designer Radiator - Matt White

Size H x W	Watts	BTU	Element Output	Element Type	Code	£ Ex VAT	£ Inc VAT
1200 x 420mm	649	2215	150W	A, A+, D, E, F, G	89.1703	321.00	385.20
1200 x 540mm	837	2856	300W	A, A+, D, E, F, G	89.1704	401.00	481.20
1800 x 420mm	888	3030	300W	A, A+, D, E, F, G	89.1695	399.00	478.80
1800 x 540mm	1146	3911	450W	A, A+, D, E, F, G	89.1696	499.00	598.80

### Lambourne Designer Radiator - Matt Anthracite

Size H x W	Watts	BTU	Element Output	Element Type	Code	£ Ex VAT	£ Inc VAT
1200 x 420mm	649	2215	150W	A, A+, D, E, F, G	89.1705	321.00	385.20
1200 x 540mm	837	2856	300W	A, A+, D, E, F, G	89.1706	401.00	481.20
1800 x 420mm	888	3030	300W	A, A+, D, E, F, G	89.1697	399.00	478.80
1800 x 540mm	1146	3911	450W	A, A+, D, E, F, G	89.1698	499.00	598.80

### Lambourne Designer Radiator - Matt Black

Size H x W	Watts	BTU	Element Output	Element Type	Code	£ Ex VAT	£ Inc VAT
1200 x 420mm	649	2215	150W	A, A+, D, E, F, G	89.1707	321.00	385.20
1200 x 540mm	837	2856	300W	A, A+, D, E, F, G	89.1708	401.00	481.20
1800 x 420mm	888	3030	300W	A, A+, D, E, F, G	89.1699	399.00	478.80
1800 x 540mm	1146	3911	450W	A, A+, D, E, F, G	89.1700	499.00	598.80

### Lambourne Designer Radiator - Chrome

Size H x W	Watts	BTU	Element Output	Element Type	Code	£ Ex VAT	£ Inc VAT
1200 x 420mm	426	1454	150W	A, A+, D, E, F, G	89.1709	427.00	512.40
1200 x 540mm	549	1874	150W	A, A+, D, E, F, G	89.1710	532.00	638.40
1800 x 420mm	652	2225	150W	A, A+, D, E, F, G	89.1701	532.00	638.40
1800 x 540mm	842	2873	300W	A, A+, D, E, F, G	89.1702	665.00	798.00



Pictured 89.1706 Matt Anthracite (bottom connection valves shown)



**Side Connection shown:** For dual fuel installation element can only be fitted vertically from the bottom inside left or right hand profile. (T piece not required)

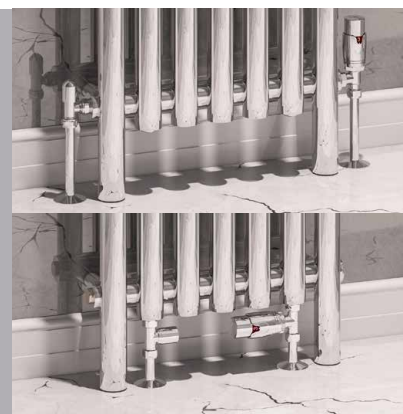

**Bottom Connection shown:** Valves can also be fitted from the bottom inlets. For electric only installation element can be fitted to the left or right hand side.

#### Matt White

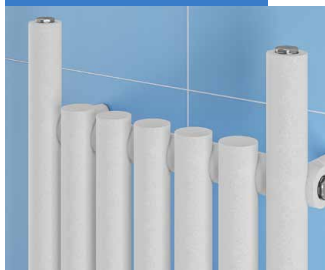

#### Matt Anthracite

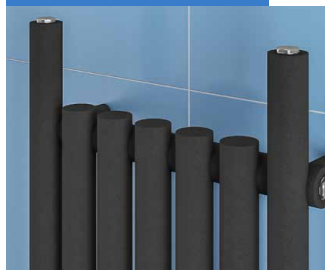

#### Matt Black



#### Chrome



# Designer Range

## MURANO VERTICAL

Pictured 89.0908 Matt Grey



Warranty

5

Year

Heating



Diameter (Ø)

22

MM Bars

Pictured 89.0916 Matt Anthracite

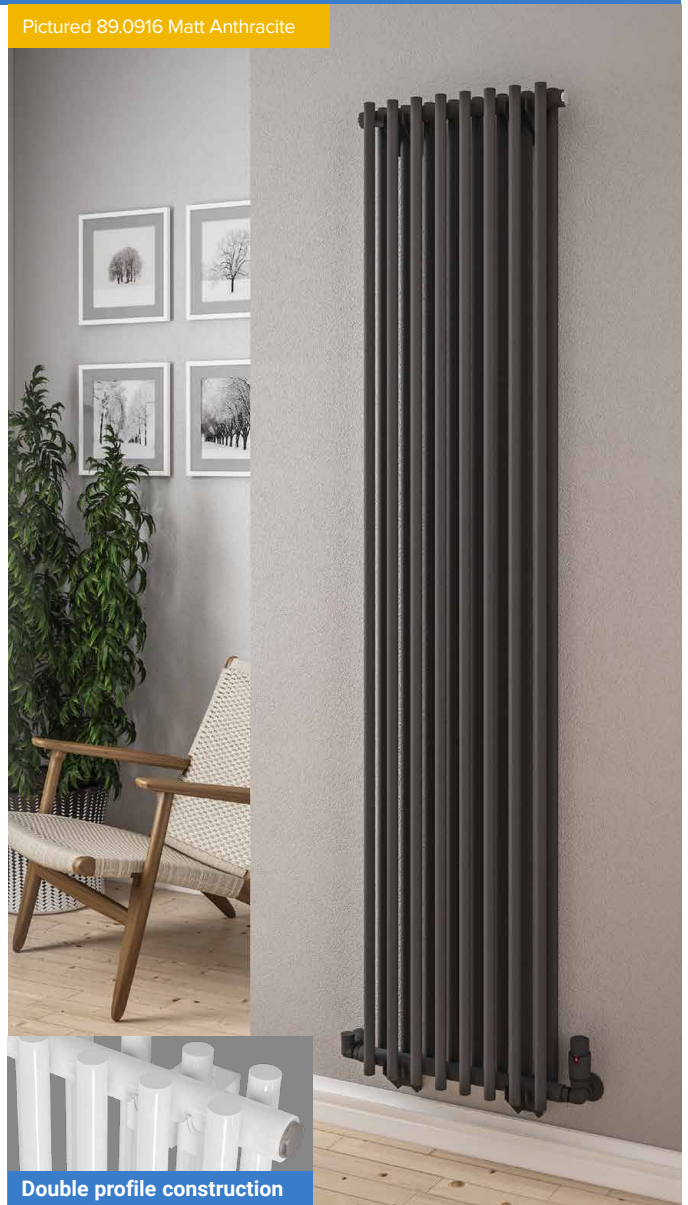

Double profile construction

### Murano Vertical Radiator - Gloss White

Size H x W	Watts	BTU	Element Output	Element Type	Code	£ Ex VAT	£ Inc VAT
1800 x 310mm	947	3232	N/A	N/A	89.0901	451.00	541.20
1800 x 410mm	1301	4440	N/A	N/A	89.0902	600.00	720.00
1800 x 510mm	1667	5688	N/A	N/A	89.0903	749.00	898.80

### Murano Vertical Radiator - Matt Grey

Size H x W	Watts	BTU	Element Output	Element Type	Code	£ Ex VAT	£ Inc VAT
1800 x 310mm	947	3232	N/A	N/A	89.0908	451.00	541.20
1800 x 410mm	1301	4440	N/A	N/A	89.0909	600.00	720.00
1800 x 510mm	1667	5688	N/A	N/A	89.0910	749.00	898.80

### Murano Vertical Radiator - Matt Anthracite

Size H x W	Watts	BTU	Element Output	Element Type	Code	£ Ex VAT	£ Inc VAT
1800 x 310mm	947	3232	N/A	N/A	89.0915	451.00	541.20
1800 x 410mm	1301	4440	N/A	N/A	89.0916	600.00	720.00
1800 x 510mm	1667	5688	N/A	N/A	89.0917	749.00	898.80

### Murano Vertical Radiator - Matt Black

Size H x W	Watts	BTU	Element Output	Element Type	Code	£ Ex VAT	£ Inc VAT
1800 x 310mm	947	3232	N/A	N/A	89.0922	451.00	541.20
1800 x 410mm	1301	4440	N/A	N/A	89.0923	600.00	720.00
1800 x 510mm	1667	5688	N/A	N/A	89.0924	749.00	898.80

Double vertical round bars and double horizontal bars create this eye catching radiator; Murano. Available in vertical horizontal styles with 4 finishes.

#### FEATURES

- 22mm diameter vertical bars
  - Double tube on tube construction
  - Tested to BS EN 442 standards
  - 4 colours available from stock
  - State-of-the-Art welding technology
  - 5 Year Manufacturer's Warranty\*
- \* With conditions

Technical Tables  
& Drawings  
Page 342-343



#### TECHNICAL INFORMATION

All measurements in Height by Width. Heat output based on  $\Delta T60^{\circ}\text{C}$ . **Not suitable for elements.** For matching valves see pages 301-309. For indirect heating systems only. Comes with built-in flow diverter. Tappings are width of the rail and approx. 50mm off the wall. Projection from wall is 86mm. Price includes radiator and wall fixing sets, valves extra.

#### Round Vent Caps

Page 313



# Designer Range

## MURANO HORIZONTAL



Warranty  
**5**  
Year

Heating

All Electric

Dual-Fuel

Diameter (Ø)  
**22**  
MM Bars

Pictured 89.0897 Gloss White



Pictured 89.0920 Matt Black

Double profile construction

Murano Horizontal Radiator - Gloss White							
Size H x W	Watts	BTU	Element Output	Element Type	Code	£ Ex VAT	£ Inc VAT
600 x 800mm	864	2948	300W	A, A+, D, F, G	89.0897	334.00	<b>400.80</b>
600 x 1000mm	1103	3764	450W	A, A+, D, F, G	89.0898	418.00	<b>501.60</b>
600 x 1200mm	1348	4600	450W	A, A+, D, F, G	89.0899	501.00	<b>601.20</b>
600 x 1400mm	1596	5446	600W	A+, D, F, G	89.0900	585.00	<b>702.00</b>

Murano Horizontal Radiator - Matt Anthracite							
Size H x W	Watts	BTU	Element Output	Element Type	Code	£ Ex VAT	£ Inc VAT
600 x 800mm	864	2948	300W	A, A+, D, F, G	89.0911	334.00	<b>400.80</b>
600 x 1000mm	1103	3764	450W	A, A+, D, F, G	89.0912	418.00	<b>501.60</b>
600 x 1200mm	1348	4600	450W	A, A+, D, F, G	89.0913	501.00	<b>601.20</b>
600 x 1400mm	1596	5446	600W	A+, D, F, G	89.0914	585.00	<b>702.00</b>

Murano Horizontal Radiator - Matt Grey							
Size H x W	Watts	BTU	Element Output	Element Type	Code	£ Ex VAT	£ Inc VAT
600 x 800mm	864	2948	300W	A, A+, D, F, G	89.0904	334.00	<b>400.80</b>
600 x 1000mm	1103	3764	450W	A, A+, D, F, G	89.0905	418.00	<b>501.60</b>
600 x 1200mm	1348	4600	450W	A, A+, D, F, G	89.0906	501.00	<b>601.20</b>
600 x 1400mm	1596	5446	600W	A+, D, F, G	89.0907	585.00	<b>702.00</b>

Murano Horizontal Radiator - Matt Black							
Size H x W	Watts	BTU	Element Output	Element Type	Code	£ Ex VAT	£ Inc VAT
600 x 800mm	864	2948	300W	A, A+, D, F, G	89.0918	334.00	<b>400.80</b>
600 x 1000mm	1103	3764	450W	A, A+, D, F, G	89.0919	418.00	<b>501.60</b>
600 x 1200mm	1348	4600	450W	A, A+, D, F, G	89.0920	501.00	<b>601.20</b>
600 x 1400mm	1596	5446	600W	A+, D, F, G	89.0921	585.00	<b>702.00</b>

**FEATURES**

- 22mm diameter horizontal bars
  - Double tube on tube construction
  - Tested to BS EN 442 standards
  - 4 colours available from stock
  - State-of-the-Art welding technology
  - Can be single, dual fuel or all electric
  - 5 Year Manufacturer's Warranty\*
- \* With conditions

**Technical Tables & Drawings**  
Page 344-345



**TECHNICAL INFORMATION**

All measurements in Height by Width. Heat output based on ▲T60°C. Radiators that are electric only are restricted to the heat output of the elements. Element size can be increased to full capacity of rail if using element type D, F or G. (Type F & G Elements suitable for all electric only) For element types see pages 288-300. For matching valves see pages 301-309. For indirect heating systems only. Tappings are approx. 45mm less than the width of the rail and approx. 81mm off the wall. Projection from wall is 117mm. Price includes radiator and wall fixing sets, valves extra.

# Designer Range

**RYTON**

Warranty

# 5

Year

Heating

All Electric

Dual-Fuel

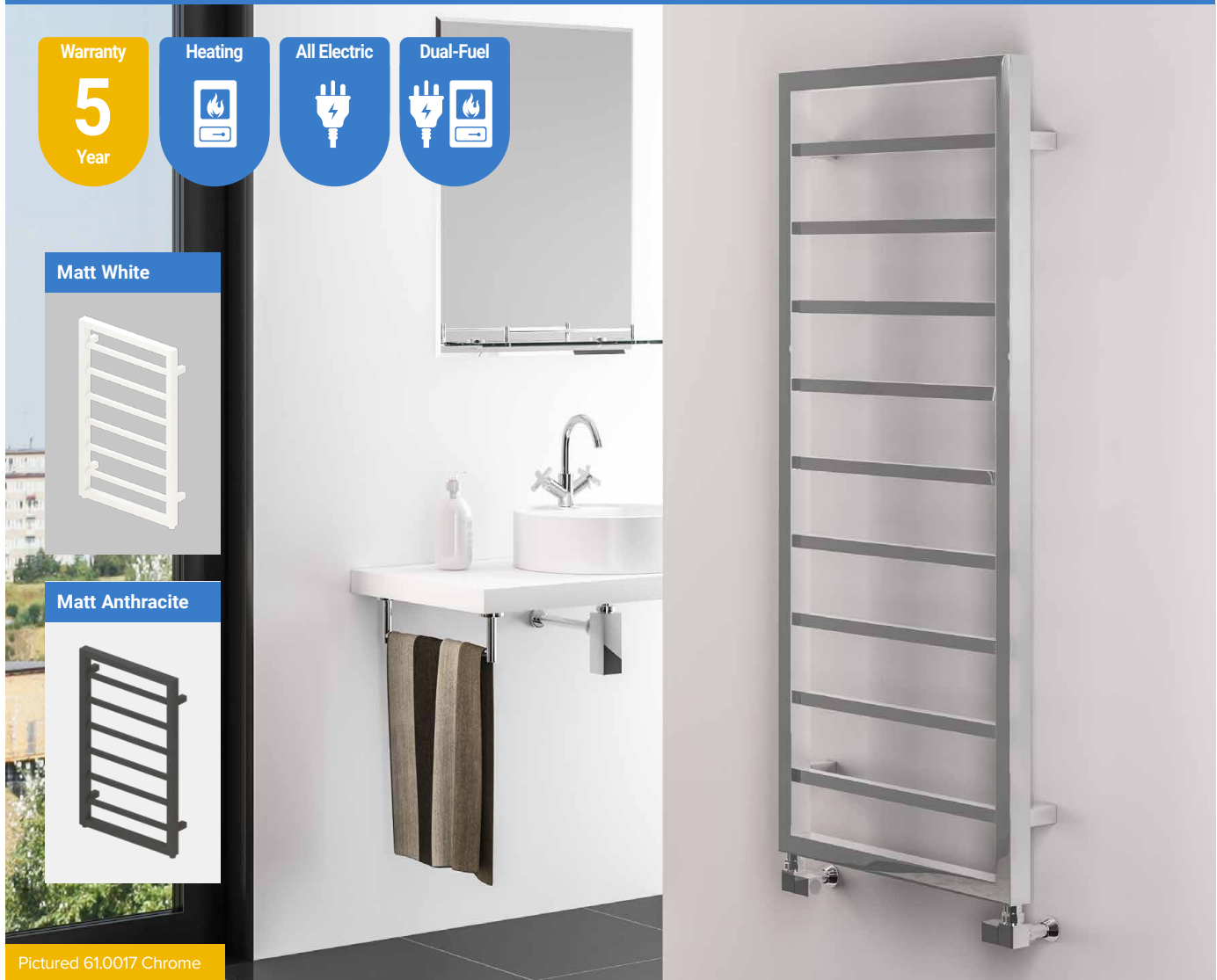
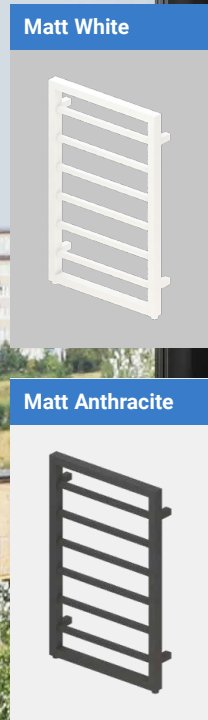

Framed rectangular designer towel rail available in a variety of finishes to create a stylish focal point in any bathroom.

**FEATURES**

- Tested to BS EN 442 standards
- A brave alternative for a basic towel radiator
- Can be single, dual fuel or all electric (element can only be fitted on the right hand side)
- 5 Year Manufacturer's Warranty\*
- \* With conditions

**Technical Tables & Drawings**

Page 344-345

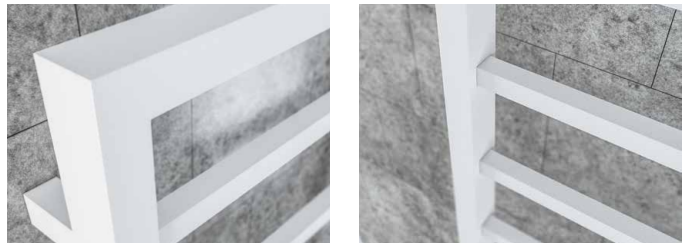

Ryton Towel Rail - Matt White							
Size H x W	Watts	BTU	Element Output	Element Type	Code	£ Ex VAT	£ Inc VAT
800 x 500mm	253	863	150W	A, A+, D, E, F, G	61.0002	291.00	<b>349.20</b>
800 x 600mm	279	951	150W	A, A+, D, E, F, G	61.0003	318.00	<b>381.60</b>
1200 x 500mm	379	1293	150W	A, A+, D, E, F, G	61.0004	363.00	<b>435.60</b>
1200 x 600mm	418	1425	150W	A, A+, D, E, F, G	61.0005	393.00	<b>471.60</b>
1600 x 500mm	505	1722	300W	A, A+, D, E, F, G	61.0006	460.00	<b>552.00</b>
1600 x 600mm	556	1898	300W	A, A+, D, E, F, G	61.0007	502.00	<b>602.40</b>

Ryton Towel Rail - Chrome							
Size H x W	Watts	BTU	Element Output	Element Type	Code	£ Ex VAT	£ Inc VAT
800 x 500mm	168	572	100W	A, A+, D, E, F, G	61.0014	434.00	<b>520.80</b>
800 x 600mm	185	630	100W	A, A+, D, E, F, G	61.0015	488.00	<b>585.60</b>
1200 x 500mm	251	856	150W	A, A+, D, E, F, G	61.0016	548.00	<b>657.60</b>
1200 x 600mm	277	944	150W	A, A+, D, E, F, G	61.0017	611.00	<b>733.20</b>
1600 x 500mm	334	1141	150W	A, A+, D, E, F, G	61.0018	663.00	<b>795.60</b>
1600 x 600mm	368	1257	150W	A, A+, D, E, F, G	61.0019	743.00	<b>891.60</b>

Ryton Towel Rail - Matt Anthracite							
Size H x W	Watts	BTU	Element Output	Element Type	Code	£ Ex VAT	£ Inc VAT
800 x 500mm	253	863	150W	A, A+, D, E, F, G	61.0008	291.00	<b>349.20</b>
800 x 600mm	279	951	150W	A, A+, D, E, F, G	61.0009	318.00	<b>381.60</b>
1200 x 500mm	379	1293	150W	A, A+, D, E, F, G	61.0010	363.00	<b>435.60</b>
1200 x 600mm	418	1425	150W	A, A+, D, E, F, G	61.0011	393.00	<b>471.60</b>
1600 x 500mm	505	1722	300W	A, A+, D, E, F, G	61.0012	460.00	<b>552.00</b>
1600 x 600mm	556	1898	300W	A, A+, D, E, F, G	61.0013	502.00	<b>602.40</b>

**TECHNICAL INFORMATION**

All measurements in Height by Width. Heat output based on  $\Delta T60^{\circ}C$ . Radiators that are electric only are restricted to the heat output of the elements. Element size can be increased to full capacity of rail if using element type D, E, F or G. Element can only be fitted on the right hand side. (Type F & G Elements suitable for all electric only) For element types see pages 288-300. For matching valves see pages 301-309. For indirect heating systems only. Tappings are approx. 30mm less than the width of the rail and approx. 75-90mm off the wall. Price includes radiator and wall fixing sets, valves extra.



# Designer Range

KENILWORTH

Warranty

5  
Year

Heating



All Electric



Dual-Fuel



Matt White



Matt Anthracite

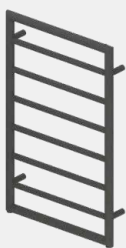

Pictured 61.0032 Chrome

A contemporary take on a traditional towel rail. This round edged framed design available in a variety of colours will be sure to suit any bathroom.

### FEATURES

- Tested to BS EN 442 standards
- A brave alternative for a basic towel radiator
- Can be single, dual fuel or all electric (element can only be fitted on the right hand side)
- 5 Year Manufacturer's Warranty\*
- \* With conditions

### Technical Tables & Drawings

Page 344-345



### Kenilworth Towel Rail - Matt White

Size H x W	Watts	BTU	Element Output	Element Type	Code	£ Ex VAT	£ Inc VAT
800 x 500mm	252	860	150W	A, A+, D, E, F, G	61.0020	277.00	<b>332.40</b>
800 x 600mm	280	956	150W	A, A+, D, E, F, G	61.0021	305.00	<b>366.00</b>
1200 x 500mm	378	1289	150W	A, A+, D, E, F, G	61.0022	350.00	<b>420.00</b>
1200 x 600mm	420	1432	150W	A, A+, D, E, F, G	61.0023	380.00	<b>456.00</b>
1600 x 500mm	503	1717	300W	A, A+, D, E, F, G	61.0024	447.00	<b>536.40</b>
1600 x 600mm	559	1908	300W	A, A+, D, E, F, G	61.0025	490.00	<b>588.00</b>

### Kenilworth Towel Rail - Matt Anthracite

Size H x W	Watts	BTU	Element Output	Element Type	Code	£ Ex VAT	£ Inc VAT
800 x 500mm	252	863	150W	A, A+, D, E, F, G	61.0026	277.00	<b>332.40</b>
800 x 600mm	280	956	150W	A, A+, D, E, F, G	61.0027	305.00	<b>366.00</b>
1200 x 500mm	378	1289	150W	A, A+, D, E, F, G	61.0028	350.00	<b>420.00</b>
1200 x 600mm	420	1432	150W	A, A+, D, E, F, G	61.0029	380.00	<b>456.00</b>
1600 x 500mm	503	1717	300W	A, A+, D, E, F, G	61.0030	447.00	<b>536.40</b>
1600 x 600mm	559	1908	300W	A, A+, D, E, F, G	61.0031	490.00	<b>588.00</b>

### Kenilworth Towel Rail - Chrome

Size H x W	Watts	BTU	Element Output	Element Type	Code	£ Ex VAT	£ Inc VAT
800 x 500mm	167	570	100W	A, A+, D, E, F, G	61.0032	416.00	<b>499.20</b>
800 x 600mm	186	633	100W	A, A+, D, E, F, G	61.0033	465.00	<b>558.00</b>
1200 x 500mm	250	854	150W	A, A+, D, E, F, G	61.0034	528.00	<b>633.60</b>
1200 x 600mm	278	948	150W	A, A+, D, E, F, G	61.0035	592.00	<b>710.40</b>
1600 x 500mm	333	1137	150W	A, A+, D, E, F, G	61.0036	636.00	<b>763.20</b>
1600 x 600mm	370	1264	150W	A, A+, D, E, F, G	61.0037	711.00	<b>853.20</b>

### TECHNICAL INFORMATION

All measurements in Height by Width. Heat output based on  $\Delta T60^{\circ}\text{C}$ . Radiators that are electric only are restricted to the heat output of the elements. Element size can be increased to full capacity of rail if using element type D, E, F or G. Element can only be fitted on the right hand side. (Type F & G Elements suitable for all electric only) For element types see pages 288-300. For matching valves see pages 301-309. For indirect heating systems only. Tappings are approx. 32mm less than the width of the rail and approx. 76-91mm off the wall. Price includes radiator and wall fixing sets, valves extra.

# Designer Range

## LOXLEY

The Loxley range features contemporary clean lines. The square tubes and profiles gives this towel rail an ultra-modern look.

### FEATURES

- Tested to BS EN 442 standards
  - Modern adaption of a traditional design
  - Concealed wall brackets
  - Can be single, dual fuel\*\* or all electric\*\* (element can only be fitted on the right hand side)
  - 5 Year Manufacturer's Warranty\*
- \* With conditions  
 \*\* Only certain sizes, see table

### Technical Tables & Drawings

Page 344-345



Warranty

**5**

Year

Heating

All Electric

Dual-Fuel



Pictured 61.0047 Chrome

Loxley Towel Rail - Matt White							
Size H x W	Watts	BTU	Element Output	Element Type	Code	£ Ex VAT	£ Inc VAT
800 x 500mm	194	663	100W	A, A+, D, F, G	61.0038	458.00	<b>549.60</b>
800 x 600mm	216	736	100W	A, A+, D, F, G	61.0039	499.00	<b>598.80</b>
1200 x 500mm	291	993	150W	A, A+, D, E, F, G	61.0040	503.00	<b>603.60</b>
1200 x 600mm	323	1102	150W	A, A+, D, E, F, G	61.0041	550.00	<b>660.00</b>

Loxley Towel Rail - Matt Anthracite							
Size H x W	Watts	BTU	Element Output	Element Type	Code	£ Ex VAT	£ Inc VAT
800 x 500mm	194	663	100W	A, A+, D, F, G	61.0042	458.00	<b>549.60</b>
800 x 600mm	216	736	100W	A, A+, D, F, G	61.0043	499.00	<b>598.80</b>
1200 x 500mm	291	993	150W	A, A+, D, E, F, G	61.0044	503.00	<b>603.60</b>
1200 x 600mm	323	1102	150W	A, A+, D, E, F, G	61.0045	550.00	<b>660.00</b>

Loxley Towel Rail - Chrome							
Size H x W	Watts	BTU	Element Output	Element Type	Code	£ Ex VAT	£ Inc VAT
800 x 500mm	129	439	N/A	N/A	61.0046	554.00	<b>664.80</b>
800 x 600mm	143	487	N/A	N/A	61.0047	623.00	<b>747.60</b>
1200 x 500mm	193	658	100W	A, A+, D, F, G	61.0048	624.00	<b>748.80</b>
1200 x 600mm	214	730	100W	A, A+, D, F, G	61.0049	698.00	<b>837.60</b>

### TECHNICAL INFORMATION

All measurements in Height by Width. Heat output based on  $\Delta T60^{\circ}C$ . Radiators that are electric only are restricted to the heat output of the elements. Element size can be increased to full capacity of rail if using element type D, E, F or G. Element can only be fitted on the right hand side. (Type F & G Elements suitable for all electric only) For element types see pages 288-300. For matching valves see pages 301-309. For indirect heating systems only. Tappings are approx. 59mm less than the width of the rail and approx. 76mm off the wall. Price includes radiator and wall fixing sets, valves extra.

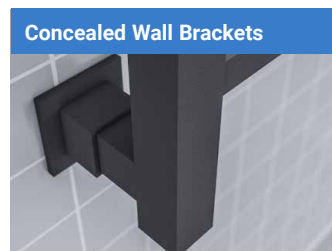
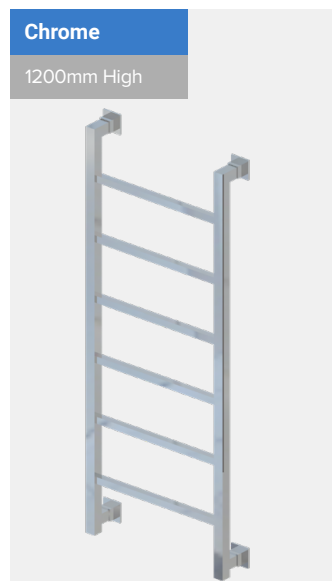
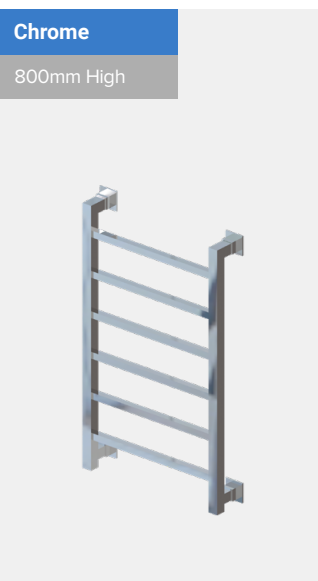

# Designer Range

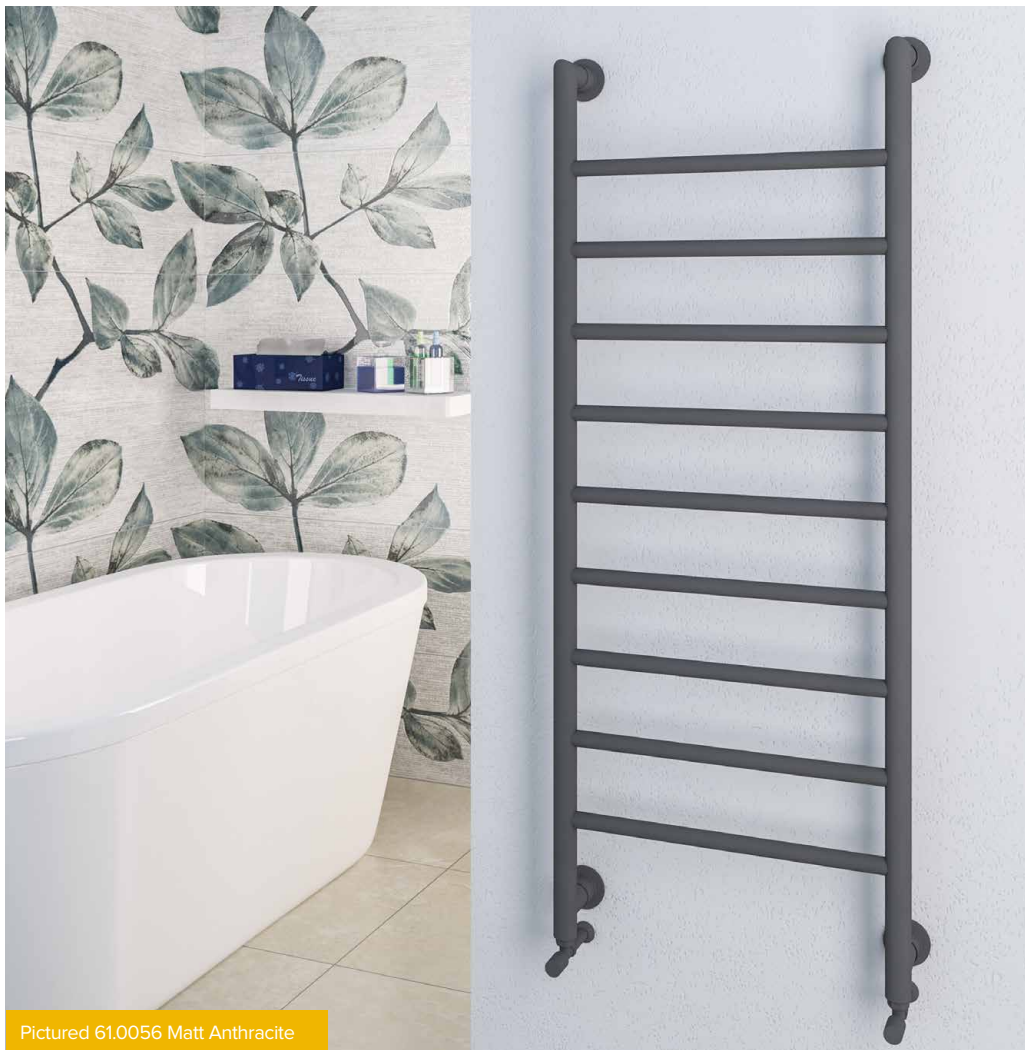

Pictured 61.0056 Matt Anthracite

## ESHTON

A fresh take on the traditional towel rail. The Eshton range features both round tubes and profiles for a complete contemporary look.

### FEATURES

- Tested to BS EN 442 standards
  - Modern adaption of a traditional design
  - Concealed wall brackets
  - Can be single, dual fuel or all electric (element can only be fitted on the right hand side)
  - 5 Year Manufacturer's Warranty\*
- \* With conditions

### Technical Tables & Drawings

Page 346-347



Warranty

# 5

Year

Heating

All Electric

Dual-Fuel

### Eshton Towel Rail - Matt White

Size H x W	Watts	BTU	Element Output	Element Type	Code	£ Ex VAT	£ Inc VAT
800 x 500mm	248	848	150W	A, A+, D, E, F, G	61.0050	416.00	<b>499.20</b>
800 x 600mm	276	942	150W	A, A+, D, E, F, G	61.0051	455.00	<b>546.00</b>
1200 x 500mm	372	1270	150W	A, A+, D, E, F, G	61.0052	465.00	<b>558.00</b>
1200 x 600mm	413	1411	150W	A, A+, D, E, F, G	61.0053	465.00	<b>558.00</b>

### Eshton Towel Rail - Matt Anthracite

Size H x W	Watts	BTU	Element Output	Element Type	Code	£ Ex VAT	£ Inc VAT
800 x 500mm	248	848	150W	A, A+, D, E, F, G	61.0054	416.00	<b>499.20</b>
800 x 600mm	276	942	150W	A, A+, D, E, F, G	61.0055	455.00	<b>546.00</b>
1200 x 500mm	372	1270	150W	A, A+, D, E, F, G	61.0056	465.00	<b>558.00</b>
1200 x 600mm	413	1411	150W	A, A+, D, E, F, G	61.0057	504.00	<b>604.80</b>

### Eshton Towel Rail - Chrome

Size H x W	Watts	BTU	Element Output	Element Type	Code	£ Ex VAT	£ Inc VAT
800 x 500mm	165	561	100W	A, A+, D, F, G	61.0058	513.00	<b>615.60</b>
800 x 600mm	183	624	100W	A, A+, D, F, G	61.0059	575.00	<b>690.00</b>
1200 x 500mm	246	841	150W	A, A+, D, E, F, G	61.0060	584.00	<b>700.80</b>
1200 x 600mm	274	934	150W	A, A+, D, E, F, G	61.0061	642.00	<b>770.40</b>

### Chrome

800mm High



### Chrome

1200mm High

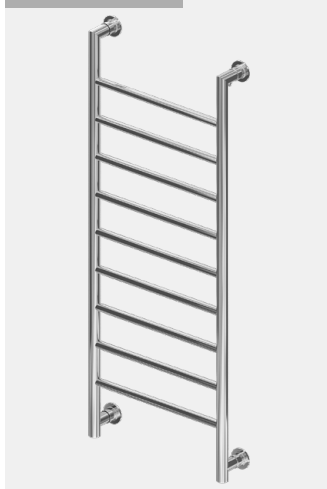

### TECHNICAL INFORMATION

All measurements in Height by Width. Heat output based on  $\Delta T60^{\circ}C$ . Radiators that are electric only are restricted to the heat output of the elements. Element size can be increased to full capacity of rail if using element type D, E, F or G. Element can only be fitted on the right hand side. (Type F & G Elements suitable for all electric only) For element types see pages 288-300. For matching valves see pages 301-309. For indirect heating systems only. Tappings are approx. 59mm less than the width of the rail and approx. 77mm off the wall. Price includes radiator and wall fixing sets, valves extra.

### Concealed Wall Brackets



### Concealed Wall Brackets



# Designer Range

## RUBANO VERTICAL

Pictured 81.0058 Gloss White

Warranty

5

Year

Heating



All Electric



Dual-Fuel



### Technical Tables & Drawings

Page 346-347



HEATING NOTE: Radiators that are electric only are restricted to the heat output of the elements.



Close-up without vent caps

A modern take on the traditional radiator. The range features larger profiles for a more contemporary look. Available in gloss white, matt anthracite and a range of sizes makes the Rubano an ideal radiator for any household room.

Rubano Vertical - Gloss White							
Size H x W	Watts	BTU	Element Output	Element Type	Code	£ Ex VAT	£ Inc VAT
1800 x 383mm	1658	5654	300W	A, A+, C*, H*	81.0058	428.00	513.60
1800 x 503mm	2210	7536	600W	A+, C**, H**	81.0059	569.00	682.80

Rubano Vertical - Matt Anthracite							
Size H x W	Watts	BTU	Element Output	Element Type	Code	£ Ex VAT	£ Inc VAT
1800 x 383mm	1658	5654	300W	A, A+, C*, H*	81.0064	436.00	523.20
1800 x 503mm	2210	7536	600W	A+, C**, H**	81.0065	580.00	696.00

\*Only 300W Element can be used. \*\* Only 900W Element can be used.

Rubano Radiator Feet			
Description	Code	£ Ex VAT	£ Inc VAT
Rubano Radiator Feet (pair) White	81.0066	37.00	44.40
Rubano Radiator Feet (pair) Matt Anthracite	81.0067	37.00	44.40

### Round Vent Caps

Page 313



# Designer Range

## RUBANO HORIZONTAL

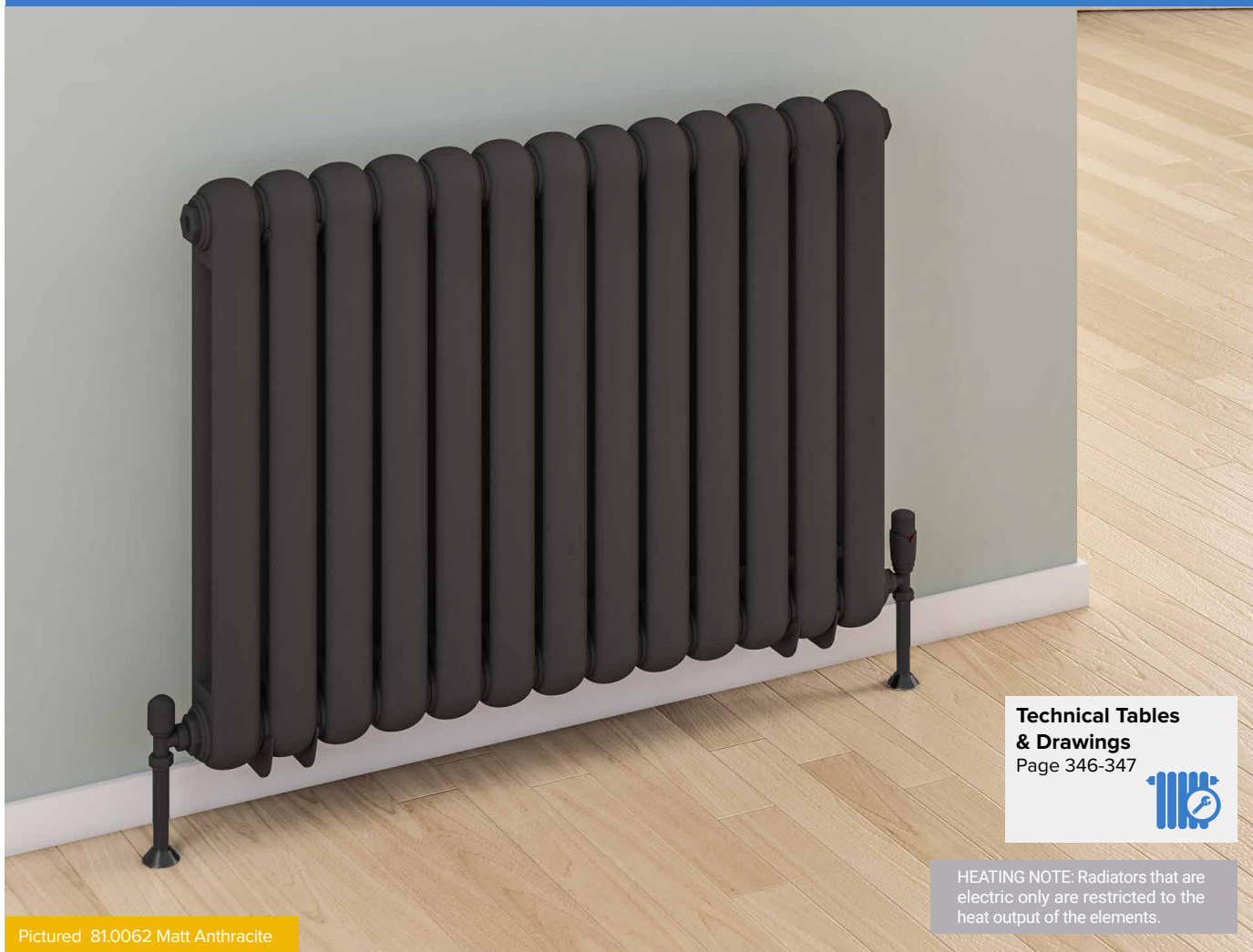

**Technical Tables & Drawings**  
Page 346-347

**HEATING NOTE:** Radiators that are electric only are restricted to the heat output of the elements.

Pictured 81.0062 Matt Anthracite

A modern take on the traditional radiator. The range features larger profiles for a more contemporary look. Available in gloss white, matt anthracite and a range of sizes makes the Rubano an ideal radiator for any household room.

Rubano Horizontal Radiators - Gloss White							
Size H x W	Watts	BTU	Element Output	Element Type	Code	£ Ex VAT	£ Inc VAT
600 x 383mm	553	1886	300W	A, A+, C*, H*	81.0054	174.00	<b>208.80</b>
600 x 623mm	921	3141	450W	A, A+, C, E**, H	81.0055	284.00	<b>340.80</b>
600 x 803mm	1197	4082	600W	A, A+, C, E, H	81.0056	367.00	<b>440.40</b>
600 x 1103mm	1658	5654	900W	A, A+, C, H	81.0057	506.00	<b>607.20</b>

\*Element Type C and H only 300W can be used. \*\*Element Type E only 300W can be used.

Rubano Horizontal Radiators - Matt Anthracite							
Size H x W	Watts	BTU	Element Output	Element Type	Code	£ Ex VAT	£ Inc VAT
600 x 383mm	553	1886	300W	A, A+, C*, H*	81.0060	177.00	<b>212.40</b>
600 x 623mm	921	3141	450W	A, A+, C, E**, H	81.0061	287.00	<b>344.40</b>
600 x 803mm	1197	4082	600W	A, A+, C, E, H	81.0062	375.00	<b>450.00</b>
600 x 1103mm	1658	5654	900W	A, A+, C, H	81.0063	516.00	<b>619.20</b>

\*Element Type C and H only 300W can be used. \*\*Element Type E only 300W can be used.

Rubano Radiator Feet			
Description	Code	£ Ex VAT	£ Inc VAT
Rubano Radiator Feet (pair) White	81.0066	37.00	<b>44.40</b>
Rubano Radiator Feet (pair) Matt Anthracite	81.0067	37.00	<b>44.40</b>

### FEATURES

- Tested to BS EN 442 standards
  - Modern style column radiator
  - Radiator feet option available to get the modern look
  - Does not require flow diverter
  - Can be single, dual fuel or all electric
  - 5 Year Manufacturer's Warranty\*
- \* With conditions

### TECHNICAL INFORMATION

All measurements in Height by Width. Heat output based on  $\Delta T60^{\circ}C$ . Radiators that are electric only are restricted to the heat output of the elements. Element size can be increased to full capacity of rail if using element type C, E or H. For element types see pages 288-300. For matching valves see pages 301-309. For indirect heating systems only. Tappings are approx. the width of the rail and 74mm off the wall. Price includes radiator and wall fixing sets, valves extra.

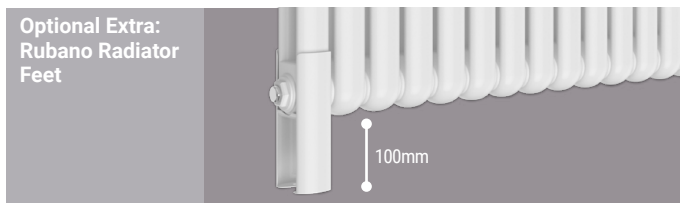

Warranty

**5**  
Year

Heating

All Electric

Dual-Fuel

**Round Vent Caps**  
Page 313

# Designer Range

## ROWSHAM VERTICAL

Pictured 89.0103 Matt White



Bar Dimensions (mm)

Vertical Bars 40 x 20mm

Pictured 89.0109 Matt Anthracite with 89.0112 Chrome Towel Hanger



The Rowsham Vertical is a designer radiator with stunning clean lines that complement any room.

### FEATURES

- 40 x 20mm vertical bars
  - Comes with pre-fitted flow diverter
  - Tested to BS EN 442 standards
  - 5 Year manufacturer's warranty\*
  - Not suitable for elements
- \* With conditions

**Technical Tables  
& Drawings**  
Page 346-347



### Rowsham Vertical - Matt White

Size H x W	Watts	BTU	Code	£ Ex VAT	£ Inc VAT
1800 x 300mm	1045	3566	89.0102	350.00	<b>420.00</b>
1800 x 380mm	1360	4641	89.0103	448.00	<b>537.60</b>
1800 x 500mm	1846	6299	89.0104	461.00	<b>553.20</b>

### Rowsham Vertical - Matt Anthracite

Size H x W	Watts	BTU	Code	£ Ex VAT	£ Inc VAT
1800 x 300mm	1045	3566	89.0109	350.00	<b>420.00</b>
1800 x 380mm	1360	4641	89.0110	448.00	<b>537.60</b>
1800 x 500mm	1846	6299	89.0111	461.00	<b>553.20</b>

# Designer Range

## ROWSHAM VERTICAL



**SWATCHES AVAILABLE**

**Technical Tables & Drawings**  
Page 346-347



**Bar Dimensions (mm)**

Vertical Bars 40 x 20mm

Pictured 89.0111 Matt Anthracite

### COMPLETE THE LOOK

Angled Thermostatic Valves  
Page: 848-849



### Round Vent Caps

Page 313



### TECHNICAL INFORMATION

All measurements in Height by Width. Heat output based on  $\Delta T60^{\circ}\text{C}$ . For matching valves see pages 301-309. For indirect heating systems only. Tappings are the width of the rail and approx. 54mm off the wall. Price includes radiator and wall fixing sets, valves extra.

Warranty

**5**  
Year

Heating



### Optional Extra - Towel Hanger - Chrome

Description	Code	£ Ex VAT	£ Inc VAT
Towel Hanger 300mm	89.0112	74.00	<b>88.80</b>

Compatible with Vertical and Horizontal Radiators. Can be fitted after installation (vertical radiators only).

# Designer Range

## ROWSHAM HORIZONTAL

Pictured 89.0098 Matt White



Bar Dimensions (mm)

Vertical Bars 40 x 20mm



Pictured 89.0107 Matt Anthracite

Technical Tables  
& Drawings  
Page 346-347



The Rowsham Horizontal is a designer radiator with stunning clean lines that complement any room.

### Rowsham Horizontal - Matt White

Size H x W	Watts	BTU	Code	£ Ex VAT	£ Inc VAT
600 x 580mm	636	2171	89.0098	324.00	<b>388.80</b>
600 x 780mm	884	3017	89.0099	363.00	<b>435.60</b>
600 x 980mm	1140	3890	89.0100	415.00	<b>498.00</b>
600 x 1180mm	1401	4781	89.0101	482.00	<b>578.40</b>

### Rowsham Horizontal - Matt Anthracite

Size H x W	Watts	BTU	Code	£ Ex VAT	£ Inc VAT
600 x 580mm	636	2171	89.0105	324.00	<b>388.80</b>
600 x 780mm	884	3017	89.0106	363.00	<b>435.60</b>
600 x 980mm	1140	3890	89.0107	415.00	<b>498.00</b>
600 x 1180mm	1401	4781	89.0108	482.00	<b>578.40</b>

#### FEATURES

- 40 x 20mm vertical bars
- Comes with pre-fitted flow diverter
- Tested to BS EN 442 standards
- 5 Year manufacturer's warranty\*
- Not suitable for elements
- \* With conditions

#### Round Vent Caps

Page 313



#### TECHNICAL INFORMATION

All measurements in Height by Width. Heat output based on  $\Delta T60^{\circ}\text{C}$ . For matching valves see pages 301-309. For indirect heating systems only. Tappings are the width of the rail and approx. 54mm off the wall. Price includes radiator and wall fixing sets, valves extra.



#### Optional Extra - Towel Hanger - Chrome

Description	Code	£ Ex VAT	£ Inc VAT
Towel Hanger 300mm	89.0112	74.00	<b>88.80</b>

Compatible with Vertical and Horizontal Radiators. Must be fitted before installation (horizontal radiators only).

Warranty

5  
Year

Heating





# Designer Range

## ROWSHAM TOWEL RAIL



**Technical Tables & Drawings**  
Page 348-349

Pictured 89.1393 Matt White Rear fixing metal wall brackets



Pictured 89.1396 Matt Anthracite **Bar Dimensions (mm)**  
Horizontal Bars 40 x 20mm

The Rowsham Towel Rail is a designer towel rail with stunning clean lines that has also high heat output.

### Rowsham Towel Rail - Matt White

Size H x W	Watts	BTU	Element Output	Element Type	Code	£ Ex VAT	£ Inc VAT
800 x 500mm	581	1983	300W	A, A+, D, E, F, G	89.1388	228.00	<b>273.60</b>
800 x 600mm	627	2140	300W	A, A+, D, E, F, G	89.1389	263.00	<b>315.60</b>
1200 x 500mm	869	2966	450W	A, A+, D, E, F, G	89.1390	375.00	<b>450.00</b>
1200 x 600mm	938	3201	600W	A, A+, D, E, F, G	89.1391	434.00	<b>520.80</b>
1800 x 500mm	1331	4542	600W	A, A+, D, E, F, G	89.1392	519.00	<b>622.80</b>
1800 x 600mm	1437	4904	750W	A, A+, D, E, F, G	89.1393	601.00	<b>721.20</b>

### Rowsham Towel Rail - Matt Anthracite

Size H x W	Watts	BTU	Element Output	Element Type	Code	£ Ex VAT	£ Inc VAT
800 x 500mm	581	1983	300W	A, A+, D, E, F, G	89.1394	228.00	<b>273.60</b>
800 x 600mm	627	2140	300W	A, A+, D, E, F, G	89.1395	263.00	<b>315.60</b>
1200 x 500mm	869	2966	450W	A, A+, D, E, F, G	89.1396	375.00	<b>450.00</b>
1200 x 600mm	938	3201	600W	A, A+, D, E, F, G	89.1397	434.00	<b>520.80</b>
1800 x 500mm	1331	4542	600W	A, A+, D, E, F, G	89.1398	519.00	<b>622.80</b>
1800 x 600mm	1437	4904	750W	A, A+, D, E, F, G	89.1399	601.00	<b>721.20</b>

Warranty

5

Year

Heating

All Electric

Dual-Fuel

### TECHNICAL INFORMATION

All measurements in Height by Width. Heat output based on  $\Delta T60^{\circ}C$ . Radiators that are electric only are restricted to the heat output of the elements. Element size can be increased to full capacity of rail if using element type D, E, F or G. (Type F & G Elements suitable for all electric only) For element types see pages 288-300. For matching valves see pages 301-309. For indirect heating systems only. Tappings are approx. 32mm less than the width of the rail and 83mm off the wall. Projection from wall is 139mm. Price includes radiator and wall fixing sets, valves extra.

**Round Vent Caps**  
Page 313

# Designer Range

## TUNSTALL VERTICAL



**Technical Tables  
& Drawings**  
Page 348-349



**Bar Dimensions (mm)**

Vertical Bars 50 x 25mm

Pictured 89.0008 Chrome & 101.0035 Towel Hanger

Warranty  
**5**  
Year

Heating

Create a fresh new look with this elegant designer radiator which will suit any room in the house. Available in four colour finishes.

**FEATURES**

- 50 x 25mm vertical bars
- Comes with pre-fitted flow diverter
- Tested to BS EN 442 standards
- 5 Year manufacturer's warranty\*
- Not suitable for elements
- \* With conditions

**Round Vent Caps**

Page 313



**Robe Hooks**

Page 310



# Designer Range

## TUNSTALL VERTICAL

Matt White



Matt Anthracite

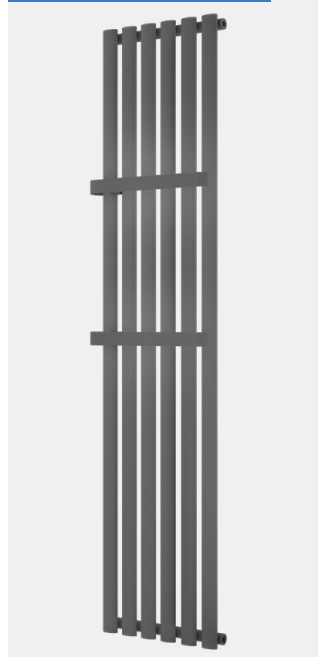

Matt Black

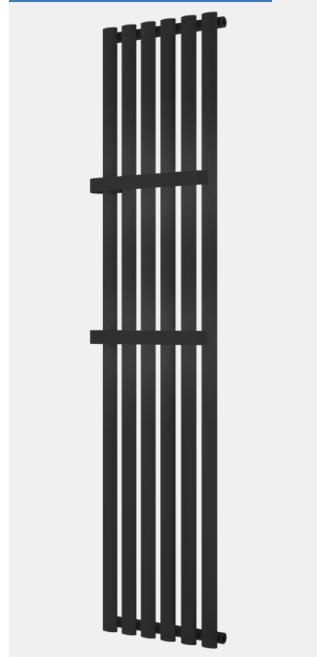

Chrome

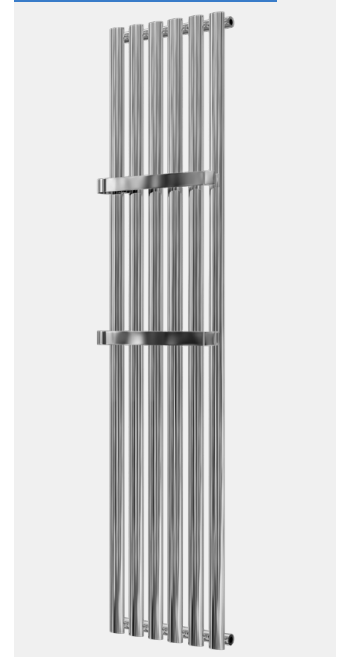

### Tunstall Vertical Radiators - Matt White

Size H x W	Watts	BTU	Element Output	Element Type	Code	£ Ex VAT	£ Inc VAT
1800 x 280mm	583	1990	N/A	N/A	89.0001	167.00	<b>200.40</b>
1800 x 350mm	750	2559	N/A	N/A	89.1620	199.00	<b>238.80</b>
1800 x 420mm	926	3160	N/A	N/A	89.0005	229.00	<b>274.80</b>
1800 x 490mm	1099	3750	N/A	N/A	89.1624	278.00	<b>333.60</b>
1800 x 560mm	1280	4368	N/A	N/A	89.1628	323.00	<b>387.60</b>
1800 x 630mm	1471	5020	N/A	N/A	89.0009	359.00	<b>430.80</b>

### Tunstall Vertical Radiators - Matt Black

Size H x W	Watts	BTU	Element Output	Element Type	Code	£ Ex VAT	£ Inc VAT
1800 x 280mm	583	1990	N/A	N/A	89.0003	167.00	<b>200.40</b>
1800 x 350mm	750	2559	N/A	N/A	89.1622	199.00	<b>238.80</b>
1800 x 420mm	926	3160	N/A	N/A	89.0007	229.00	<b>274.80</b>
1800 x 490mm	1099	3750	N/A	N/A	89.1626	278.00	<b>333.60</b>
1800 x 560mm	1280	4368	N/A	N/A	89.1630	323.00	<b>387.60</b>
1800 x 630mm	1471	5020	N/A	N/A	89.0011	359.00	<b>430.80</b>

### Tunstall Vertical Radiators - Matt Anthracite

Size H x W	Watts	BTU	Element Output	Element Type	Code	£ Ex VAT	£ Inc VAT
1800 x 280mm	583	1990	N/A	N/A	89.0002	167.00	<b>200.40</b>
1800 x 350mm	750	2559	N/A	N/A	89.1621	199.00	<b>238.80</b>
1800 x 420mm	926	3160	N/A	N/A	89.0006	229.00	<b>274.80</b>
1800 x 490mm	1099	3750	N/A	N/A	89.1625	278.00	<b>333.60</b>
1800 x 560mm	1280	4368	N/A	N/A	89.1629	323.00	<b>387.60</b>
1800 x 630mm	1471	5020	N/A	N/A	89.0010	359.00	<b>430.80</b>

### Tunstall Vertical Radiators - Chrome

Size H x W	Watts	BTU	Element Output	Element Type	Code	£ Ex VAT	£ Inc VAT
1800 x 280mm	320	1092	N/A	N/A	89.0004	387.00	<b>464.40</b>
1800 x 350mm	423	1444	N/A	N/A	89.1623	418.00	<b>501.60</b>
1800 x 420mm	533	1819	N/A	N/A	89.0008	448.00	<b>537.60</b>
1800 x 490mm	644	2198	N/A	N/A	89.1627	497.00	<b>596.40</b>
1800 x 560mm	760	2594	N/A	N/A	89.1631	548.00	<b>657.60</b>
1800 x 630mm	890	3037	N/A	N/A	89.0012	592.00	<b>710.40</b>

### TECHNICAL INFORMATION

All measurements in Height by Width. Heat output based on  $\Delta T60^{\circ}\text{C}$ . For matching valves see pages 301-309. **Not suitable for elements.** For indirect heating systems only. Tappings are the width of the rail and approx. 52mm off the wall. Price includes radiator and wall fixing sets, valves extra.

### Vertical Tunstall Towel Hangers



Towel Hanger - Matt White

Size	Code	£ Ex VAT	£ Inc VAT
280mm	101.0028	60.00	<b>72.00</b>
350mm	89.1741	65.00	<b>78.00</b>
420mm	101.0032	73.00	<b>87.60</b>
490mm	89.1742	77.00	<b>92.40</b>
560mm	89.1743	80.00	<b>96.00</b>
630mm	101.0036	84.00	<b>100.80</b>



Towel Hanger - Matt Anthracite

Size	Code	£ Ex VAT	£ Inc VAT
280mm	101.0029	60.00	<b>72.00</b>
350mm	89.1744	65.00	<b>78.00</b>
420mm	101.0033	73.00	<b>87.60</b>
490mm	89.1745	77.00	<b>92.40</b>
560mm	89.1746	80.00	<b>96.00</b>
630mm	101.0037	84.00	<b>100.80</b>



Towel Hanger - Matt Black

Size	Code	£ Ex VAT	£ Inc VAT
280mm	101.0030	60.00	<b>72.00</b>
350mm	89.1747	65.00	<b>78.00</b>
420mm	101.0034	73.00	<b>87.60</b>
490mm	89.1748	77.00	<b>92.40</b>
560mm	89.1749	80.00	<b>96.00</b>
630mm	101.0038	84.00	<b>100.80</b>



Towel Hanger - Chrome

Size	Code	£ Ex VAT	£ Inc VAT
280mm	101.0031	65.00	<b>78.00</b>
350mm	89.1750	72.00	<b>86.40</b>
420mm	101.0035	79.00	<b>94.80</b>
490mm	89.1751	84.00	<b>100.80</b>
560mm	89.1752	87.00	<b>104.40</b>
630mm	101.0039	90.00	<b>108.00</b>

The Vertical Tunstall Towel Hangers can be fitted on both sides of the radiator (as left hand or right hand).

**Must be fitted before installation!**

# Designer Range

## TUNSTALL HORIZONTAL

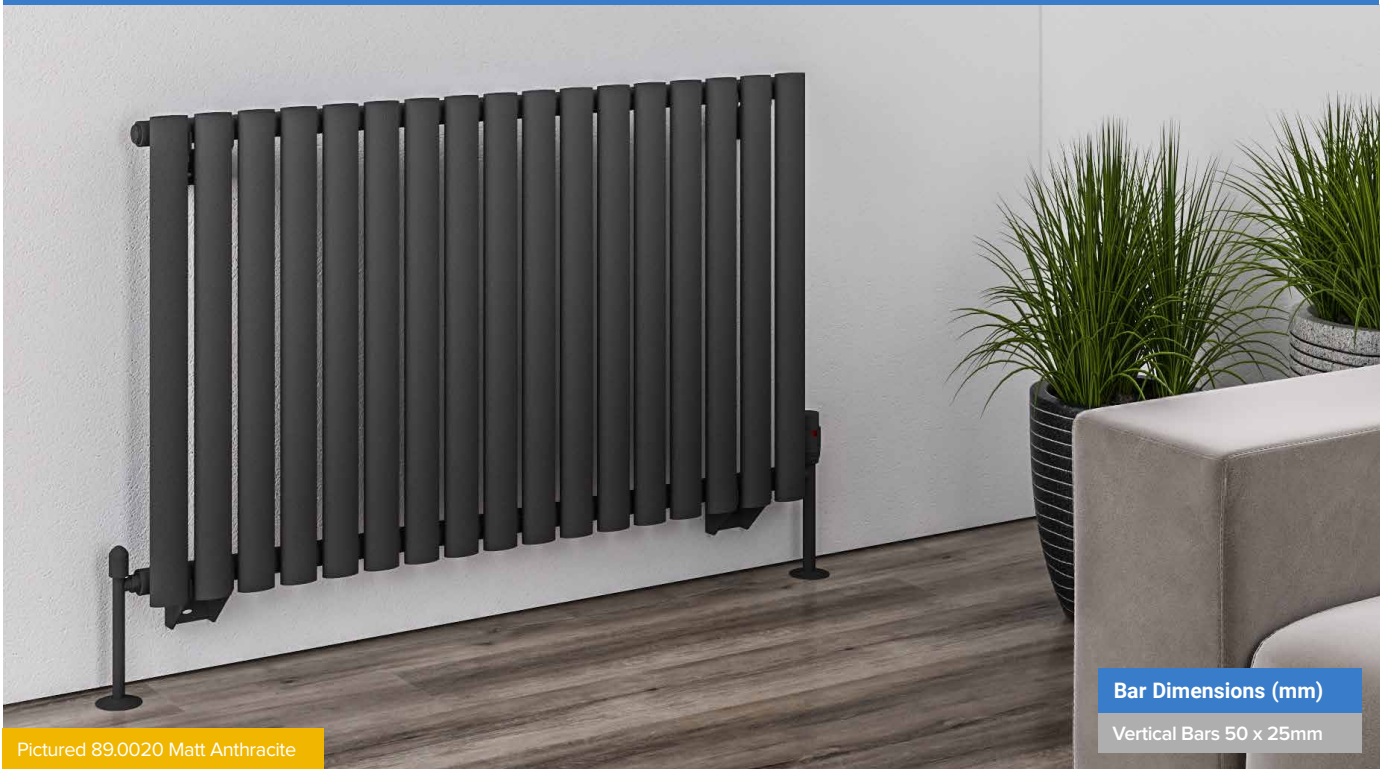

The elliptical shape of these tubes will provide a stylish focus to any room. Available in three colours.

### FEATURES

- 50 x 25mm vertical bars
- Comes with pre-fitted flow diverter
- Tested to BS EN 442 standards
- 5 Year manufacturer's warranty\*
- Not suitable for elements
- \* With conditions

### Technical Tables & Drawings

Page 348-349



### TECHNICAL INFORMATION

All measurements in Height by Width. Heat output based on  $\Delta T60^{\circ}C$ . For matching valves see pages 301-309. **Not suitable for elements.** For indirect heating systems only. Tappings are the width of the rail and approx. 52mm off the wall. Price includes radiator and wall fixing sets, valves extra.

### Tunstall Horizontal Radiators - Matt White

Size H x W	Watts	BTU	Element Output	Element Type	Code	£ Ex VAT	£ Inc VAT
600 x 471mm	399	1362	N/A	N/A	89.1632	137.00	<b>164.40</b>
600 x 589mm	509	1737	N/A	N/A	89.0013	153.00	<b>183.60</b>
600 x 648mm	565	1928	N/A	N/A	89.1635	167.00	<b>200.40</b>
600 x 825mm	742	2532	N/A	N/A	89.0016	207.00	<b>248.40</b>
600 x 1002mm	928	3167	N/A	N/A	89.0019	252.00	<b>302.40</b>
600 x 1061mm	1003	3423	N/A	N/A	89.1638	271.00	<b>325.20</b>
600 x 1179mm	1123	3832	N/A	N/A	89.0022	296.00	<b>355.20</b>

### Tunstall Horizontal Radiators - Matt Anthracite

Size H x W	Watts	BTU	Element Output	Element Type	Code	£ Ex VAT	£ Inc VAT
600 x 471mm	399	1362	N/A	N/A	89.1633	137.00	<b>164.40</b>
600 x 589mm	509	1737	N/A	N/A	89.0014	153.00	<b>183.60</b>
600 x 648mm	565	1928	N/A	N/A	89.1636	167.00	<b>200.40</b>
600 x 825mm	742	2532	N/A	N/A	89.0017	207.00	<b>248.40</b>
600 x 1002mm	928	3167	N/A	N/A	89.0020	252.00	<b>302.40</b>
600 x 1061mm	1003	3423	N/A	N/A	89.1639	271.00	<b>325.20</b>
600 x 1179mm	1123	3832	N/A	N/A	89.0023	296.00	<b>355.20</b>

### Tunstall Horizontal Radiators - Matt Black

Size H x W	Watts	BTU	Element Output	Element Type	Code	£ Ex VAT	£ Inc VAT
600 x 471mm	399	1362	N/A	N/A	89.1634	137.00	<b>164.40</b>
600 x 589mm	509	1737	N/A	N/A	89.0015	153.00	<b>183.60</b>
600 x 648mm	565	1928	N/A	N/A	89.1637	167.00	<b>200.40</b>
600 x 825mm	742	2532	N/A	N/A	89.0018	207.00	<b>248.40</b>
600 x 1002mm	928	3167	N/A	N/A	89.0021	252.00	<b>302.40</b>
600 x 1061mm	1003	3423	N/A	N/A	89.1640	271.00	<b>325.20</b>
600 x 1179mm	1123	3832	N/A	N/A	89.0024	296.00	<b>355.20</b>



### Round Vent Caps

Page 313



## Horizontal Tunstall Towel Hangers



Size	Code	£ Ex VAT	£ Inc VAT
330mm	101.0040	70.00	<b>84.00</b>
589mm	101.0044	84.00	<b>100.80</b>



Size	Code	£ Ex VAT	£ Inc VAT
330mm	101.0041	70.00	<b>84.00</b>
589mm	101.0045	84.00	<b>100.80</b>



Size	Code	£ Ex VAT	£ Inc VAT
330mm	101.0042	70.00	<b>84.00</b>
589mm	101.0046	84.00	<b>100.80</b>



Size	Code	£ Ex VAT	£ Inc VAT
330mm	101.0043	70.00	<b>84.00</b>
589mm	101.0047	90.00	<b>108.00</b>

The Horizontal Tunstall Towel Hangers can be fitted on both sides of the radiator (as left hand or right hand).

**Must be fitted before installation!**

# Designer Range

## Tunstall Towel Rails - Matt White

Size H x W	Watts	BTU	Element Output	Element Type	Code	£ Ex VAT	£ Inc VAT
560 x 1000mm	690	2355	300W	A, A+, D, E, F, G	89.0025	257.00	<b>308.40</b>
800 x 500mm	454	1550	150W	A, A+, D, E, F, G	89.0029	178.00	<b>213.60</b>
800 x 600mm	524	1788	300W	A, A+, D, E, F, G	89.0041	195.00	<b>234.00</b>
1200 x 500mm	663	2263	300W	A, A+, D, E, F, G	89.0033	268.00	<b>321.60</b>
1200 x 600mm	766	2614	450W	A, A+, D, E, F, G	89.0045	296.00	<b>355.20</b>
1600 x 500mm	879	3000	450W	A, A+, D, E, F, G	89.0037	330.00	<b>396.00</b>
1600 x 600mm	1015	3464	600W	A, A+, D, E, F, G	89.0049	373.00	<b>447.60</b>

## Tunstall Towel Rails - Matt Anthracite

Size H x W	Watts	BTU	Element Output	Element Type	Code	£ Ex VAT	£ Inc VAT
560 x 1000mm	690	2355	300W	A, A+, D, E, F, G	89.0026	257.00	<b>308.40</b>
800 x 500mm	454	1550	150W	A, A+, D, E, F, G	89.0030	178.00	<b>213.60</b>
800 x 600mm	524	1788	300W	A, A+, D, E, F, G	89.0042	195.00	<b>234.00</b>
1200 x 500mm	663	2263	300W	A, A+, D, E, F, G	89.0034	268.00	<b>321.60</b>
1200 x 600mm	766	2614	450W	A, A+, D, E, F, G	89.0046	296.00	<b>355.20</b>
1600 x 500mm	879	3000	450W	A, A+, D, E, F, G	89.0038	330.00	<b>396.00</b>
1600 x 600mm	1015	3464	600W	A, A+, D, E, F, G	89.0050	373.00	<b>447.60</b>

## Tunstall Towel Rails - Matt Black

Size H x W	Watts	BTU	Element Output	Element Type	Code	£ Ex VAT	£ Inc VAT
560 x 1000mm	690	2355	300W	A, A+, D, E, F, G	89.0027	257.00	<b>308.40</b>
800 x 500mm	454	1550	150W	A, A+, D, E, F, G	89.0031	178.00	<b>213.60</b>
800 x 600mm	524	1788	300W	A, A+, D, E, F, G	89.0043	195.00	<b>234.00</b>
1200 x 500mm	663	2263	300W	A, A+, D, E, F, G	89.0035	268.00	<b>321.60</b>
1200 x 600mm	766	2614	450W	A, A+, D, E, F, G	89.0047	296.00	<b>355.20</b>
1600 x 500mm	879	3000	450W	A, A+, D, E, F, G	89.0039	330.00	<b>396.00</b>
1600 x 600mm	1015	3464	600W	A, A+, D, E, F, G	89.0051	373.00	<b>447.60</b>

## Tunstall Towel Rails - Chrome

Size H x W	Watts	BTU	Element Output	Element Type	Code	£ Ex VAT	£ Inc VAT
560 x 1000mm	431	1471	150W	A, A+, D, E, F, G	89.0028	376.00	<b>451.20</b>
800 x 500mm	284	970	150W	A, A+, D, E, F, G	89.0032	323.00	<b>387.60</b>
800 x 600mm	326	1113	150W	A, A+, D, E, F, G	89.0044	356.00	<b>427.20</b>
1200 x 500mm	431	1471	150W	A, A+, D, E, F, G	89.0036	386.00	<b>463.20</b>
1200 x 600mm	493	1683	300W	A, A+, D, E, F, G	89.0048	423.00	<b>507.60</b>
1600 x 500mm	579	1976	300W	A, A+, D, E, F, G	89.0040	486.00	<b>583.20</b>
1600 x 600mm	661	2256	300W	A, A+, D, E, F, G	89.0052	534.00	<b>640.80</b>

### TECHNICAL INFORMATION

All measurements in Height by Width. Heat output based on ▲T60°C. Radiators that are electric only are restricted to the heat output of the elements. Element size can be increased to full capacity of rail if using element type D, E, F or G. (Type F & G Elements suitable for all electric only) For element types see pages 288-300. For matching valves see pages 301-309. For indirect heating systems only. Tappings are approx. 46mm less than the width of the rail and approx. 83mm off the wall. Price includes radiator and wall fixing sets, valves extra.

**Robe Hooks**  
Page 310

**Round Vent Caps**  
Page 313

Warranty  
**5**  
Year

Heating

All Electric

Dual-Fuel

Pictured 89.0025  
Matt White

560x1000mm size is the only horizontal Tunstall Towel Rail

## TUNSTALL TOWEL RAILS

**Technical Tables & Drawings**  
Page 348-349

**Bar Dimensions (mm)**  
Horizontal Bars 50 x 25mm

Pictured 89.0048 Chrome

- FEATURES**
- 50 x 25mm horizontal bars
  - Tested to BS EN 442 standards
  - 5 Year manufacturer's warranty\*
  - Stunning chrome finish option available
  - \* With conditions

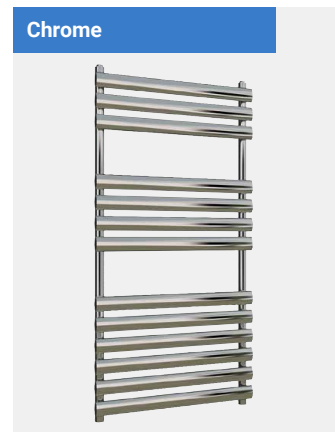
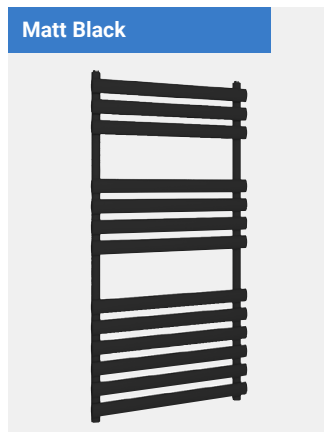
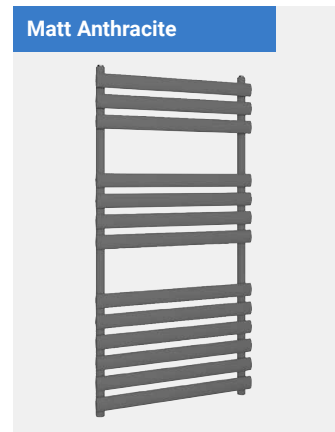

# Designer Range

## TUNSTALL DOUBLE VERTICAL



Pictured 81.0142 Matt White

Technical Tables  
& Drawings  
Page 348-349



Bar Dimensions (mm)

Vertical Bars 50 x 25mm

With its double vertical profile construction, Tunstall Double will create a fresh new look for any room in the house. Available in two colour finishes.

### FEATURES

- 50 x 25mm vertical bars
- Double vertical profile construction
- Tested to BS EN 442 standards
- 5 Year manufacturer's warranty\*
- Not suitable for elements
- \* With conditions

### TECHNICAL INFORMATION

All measurements in Height by Width. Heat output based on  $\Delta T60^{\circ}\text{C}$ . For matching valves see pages 301-309. **Not suitable for elements.** For indirect heating systems only. Tappings are the width of the rail and approx. 65mm off the wall. Projection from wall 104mm. Price includes radiator and wall fixing sets, valves extra.

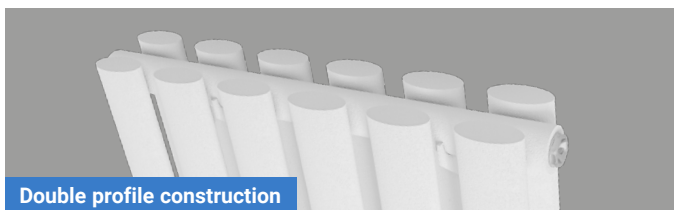

Double profile construction

Warranty

5  
Year

Heating



Round Vent Caps

Page 313



# Designer Range

## TUNSTALL DOUBLE VERTICAL

### Tunstall Double Vertical Radiators - Matt White

Size H x W	Watts	BTU	Element Output	Element Type	Code	£ Ex VAT	£ Inc VAT
1800 x 280mm	952	3249	N/A	N/A	81.0140	247.00	<b>296.40</b>
1800 x 350mm	1190	4058	N/A	N/A	81.0190	311.00	<b>373.20</b>
1800 x 420mm	1429	4877	N/A	N/A	81.0141	368.00	<b>441.60</b>
1800 x 490mm	1666	5681	N/A	N/A	81.0193	416.00	<b>499.20</b>
1800 x 560mm	1904	6493	N/A	N/A	81.0196	485.00	<b>582.00</b>
1800 x 630mm	2142	7311	N/A	N/A	81.0142	552.00	<b>662.40</b>

### Tunstall Double Vertical Radiators - Matt Anthracite

Size H x W	Watts	BTU	Element Output	Element Type	Code	£ Ex VAT	£ Inc VAT
1800 x 280mm	952	3249	N/A	N/A	81.0158	251.00	<b>301.20</b>
1800 x 350mm	1190	4058	N/A	N/A	81.0191	320.00	<b>384.00</b>
1800 x 420mm	1429	4877	N/A	N/A	81.0159	377.00	<b>452.40</b>
1800 x 490mm	1666	5681	N/A	N/A	81.0194	425.00	<b>510.00</b>
1800 x 560mm	1904	6493	N/A	N/A	81.0197	494.00	<b>592.80</b>
1800 x 630mm	2142	7311	N/A	N/A	81.0160	563.00	<b>675.60</b>

### Tunstall Double Vertical Radiators - Matt Black

Size H x W	Watts	BTU	Element Output	Element Type	Code	£ Ex VAT	£ Inc VAT
1800 x 280mm	952	3249	N/A	N/A	81.0172	251.00	<b>301.20</b>
1800 x 350mm	1190	4058	N/A	N/A	81.0192	320.00	<b>384.00</b>
1800 x 420mm	1429	4877	N/A	N/A	81.0173	377.00	<b>452.40</b>
1800 x 490mm	1666	5681	N/A	N/A	81.0195	425.00	<b>510.00</b>
1800 x 560mm	1904	6493	N/A	N/A	81.0198	494.00	<b>592.80</b>
1800 x 630mm	2142	7311	N/A	N/A	81.0174	563.00	<b>675.60</b>



Pictured 81.0195 Matt Black



Pictured 81.0159 Matt Anthracite

### Radiator Valves

Page 301-309



### Multi-Purpose Towel Hangers

Page 312



# Designer Range

## TUNSTALL DOUBLE HORIZONTAL



**Bar Dimensions (mm)**

Vertical Bars 50 x 25mm

Pictured 81.0137 Matt White



**Technical Tables & Drawings**  
Page 350-351



Pictured 81.0156 Matt Anthracite

With its double vertical profile construction, Tunstall Double will provide a stylish focus to any room in the house. Available in two colour finishes.

**FEATURES**

- 50 x 25mm vertical bars
- Double vertical profile construction
- Tested to BS EN 442 standards
- 5 Year manufacturer's warranty\*
- Not suitable for elements
- \* With conditions

**TECHNICAL INFORMATION**

All measurements in Height by Width. Heat output based on  $\Delta T60^{\circ}\text{C}$ . For matching valves see pages 301-309. **Not suitable for elements.** For indirect heating systems only. Tappings are the width of the rail and approx. 65mm off the wall. Projection from wall 104mm. Price includes radiator and wall fixing sets, valves extra.



Double profile construction

Warranty

**5**

Year

Heating

**Round Vent Caps**  
Page 313





# Designer Range

## TUNSTALL DOUBLE HORIZONTAL



Pictured 81.0175 Matt Black

### Tunstall Double Horizontal Radiators - Matt White

Size H x W	Watts	BTU	Element Output	Element Type	Code	£ Ex VAT	£ Inc VAT
600 x 471mm	734	2503	N/A	N/A	81.0199	216.00	259.20
600 x 589mm	818	2792	N/A	N/A	81.0136	268.00	321.60
600 x 648mm	1010	3444	N/A	N/A	81.0202	307.00	368.40
600 x 825mm	1145	3908	N/A	N/A	81.0137	375.00	450.00
600 x 1002mm	1391	4747	N/A	N/A	81.0138	453.00	543.60
600 x 1061mm	1652	5633	N/A	N/A	81.0205	492.00	590.40
600 x 1179mm	1836	6266	N/A	N/A	81.0139	531.00	637.20

### Tunstall Double Horizontal Radiators - Matt Black

Size H x W	Watts	BTU	Element Output	Element Type	Code	£ Ex VAT	£ Inc VAT
600 x 471mm	734	2503	N/A	N/A	81.0201	224.00	268.80
600 x 589mm	818	2792	N/A	N/A	81.0175	275.00	330.00
600 x 648mm	1010	3444	N/A	N/A	81.0204	315.00	378.00
600 x 825mm	1145	3908	N/A	N/A	81.0176	381.00	457.20
600 x 1002mm	1391	4747	N/A	N/A	81.0177	460.00	552.00
600 x 1061mm	1652	5633	N/A	N/A	81.0207	502.00	602.40
600 x 1179mm	1836	6266	N/A	N/A	81.0178	543.00	651.60

### Tunstall Double Horizontal Radiators - Matt Anthracite

Size H x W	Watts	BTU	Element Output	Element Type	Code	£ Ex VAT	£ Inc VAT
600 x 471mm	734	2503	N/A	N/A	81.0200	224.00	268.80
600 x 589mm	818	2792	N/A	N/A	81.0154	275.00	330.00
600 x 648mm	1010	3444	N/A	N/A	81.0203	315.00	378.00
600 x 825mm	1145	3908	N/A	N/A	81.0155	381.00	457.20
600 x 1002mm	1391	4747	N/A	N/A	81.0156	460.00	552.00
600 x 1061mm	1652	5633	N/A	N/A	81.0206	502.00	602.40
600 x 1179mm	1836	6266	N/A	N/A	81.0157	543.00	651.60

### Multi-Purpose Towel Hangers

Page 312



## COMPLETE THE LOOK

**41.3023**

**15mm TRV & Lockshield - Matt White**

Code	£ Ex VAT	£ Inc VAT
41.3023	47.00	56.40

**41.3024**

**15mm TRV & Lockshield - Matt Anthracite**

Code	£ Ex VAT	£ Inc VAT
41.3024	47.00	56.40

**41.3025**

**15mm TRV & Lockshield - Matt Black**

Code	£ Ex VAT	£ Inc VAT
41.3025	47.00	56.40

# Designer Range

## TUNSTALL DOUBLE TOWEL RAIL



Warranty  
**5**  
Year

Heating

Dual-Fuel

Vertical Sizes (x6)

- H800 X W500/600
- H1200 x W500/600
- H1600 x W500/600

Horizontal Size (x1)

H560 X W1000

Pictured 81.0149 Matt White

Double horizontal profiles in elliptical shape of this towel rail will warm your towels and also your bathroom. Available in two colour options.

### FEATURES

- 50 x 25mm horizontal bars
- Double horizontal profile construction
- Tested to BS EN 442 standards
- 5 Year manufacturer's warranty\*
- Can be single, dual fuel or all electric
- \* With conditions

Tunstall Double Towel Rails - Matt White							
Size H x W	Watts	BTU	Element Output	Element Type	Code	£ Ex VAT	£ Inc VAT
560 x 1000mm	1060	3618	600W	A, A+, D, E, F, G	81.0149	362.00	434.40
800 x 500mm	620	2116	300W	A, A+, D, E, F, G	81.0143	281.00	337.20
800 x 600mm	742	2532	450W	A, A+, D, E, F, G	81.0146	299.00	358.80
1200 x 500mm	893	3048	450W	A, A+, D, E, F, G	81.0144	401.00	481.20
1200 x 600mm	1072	3659	600W	A, A+, D, E, F, G	81.0147	431.00	517.20
1600 x 500mm	1170	3993	600W	A, A+, D, E, F, G	81.0145	524.00	628.80
1600 x 600mm	1405	4795	750W	A, A+, D, E, F, G	81.0148	562.00	674.40

Tunstall Double Towel Rails - Matt Anthracite							
Size H x W	Watts	BTU	Element Output	Element Type	Code	£ Ex VAT	£ Inc VAT
560 x 1000mm	1060	3618	600W	A, A+, D, E, F, G	81.0167	362.00	434.40
800 x 500mm	620	2116	300W	A, A+, D, E, F, G	81.0161	281.00	337.20
800 x 600mm	742	2532	450W	A, A+, D, E, F, G	81.0164	299.00	358.80
1200 x 500mm	893	3048	450W	A, A+, D, E, F, G	81.0162	401.00	481.20
1200 x 600mm	1072	3659	600W	A, A+, D, E, F, G	81.0165	431.00	517.20
1600 x 500mm	1170	3993	600W	A, A+, D, E, F, G	81.0163	524.00	628.80
1600 x 600mm	1405	4795	750W	A, A+, D, E, F, G	81.0166	562.00	674.40

Tunstall Double Towel Rails - Matt Black							
Size H x W	Watts	BTU	Element Output	Element Type	Code	£ Ex VAT	£ Inc VAT
560 x 1000mm	1060	3618	600W	A, A+, D, E, F, G	81.0179	362.00	434.40
800 x 500mm	620	2116	300W	A, A+, D, E, F, G	81.0180	281.00	337.20
800 x 600mm	742	2532	450W	A, A+, D, E, F, G	81.0181	299.00	358.80
1200 x 500mm	893	3048	450W	A, A+, D, E, F, G	81.0182	401.00	481.20
1200 x 600mm	1072	3659	600W	A, A+, D, E, F, G	81.0183	431.00	517.20
1600 x 500mm	1170	3993	600W	A, A+, D, E, F, G	81.0184	524.00	628.80
1600 x 600mm	1405	4795	750W	A, A+, D, E, F, G	81.0185	562.00	674.40

### TECHNICAL INFORMATION

All measurements in Height by Width. Heat output based on ▲T60°C. Radiators that are electric only are restricted to the heat output of the elements. Element size can be increased to full capacity of rail if using element type D, E, F or G. (Type F & G Elements suitable for all electric only) For element types see pages 288-300. For matching valves see pages 301-309. For indirect heating systems only. Tappings are approx. 46mm less than the width of the rail and approx. 70-75mm off the wall. Price includes radiator and wall fixing sets, valves extra.



Technical Tables & Drawings  
Page 350-351



Pictured 81.0162 Matt Anthracite

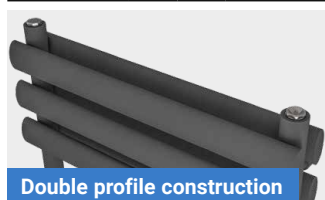

Double profile construction

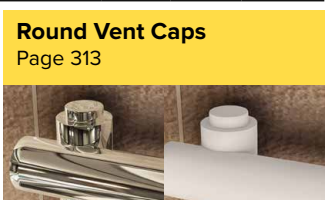

Round Vent Caps  
Page 313

# Designer Range

### TUNSTALL MIRROR

**Warranty**  
**5**  
Year

**Heating**

**Technical Tables & Drawings**  
Page 350-351

**Bar Dimensions (mm)**  
Vertical Bars 50 x 25mm

145mm

Pictured 81.0169 Matt Anthracite

Profiles in elliptical shape of this radiator is in perfect harmony with the mirror placed in the middle. Available in two colour options.

#### FEATURES

- Single vertical profile construction, mirror width 145mm
  - Tested to BS EN 442 standards
  - 5 Year manufacturer's warranty\*
  - Not suitable for elements
- \* With conditions

Tunstall Mirror Radiators - Matt White							
Size H x W	Watts	BTU	Element Output	Element Type	Code	£ Ex VAT	£ Inc VAT
1800 x 380mm	705	2406	N/A	N/A	81.0150	297.00	356.40
1800 x 500mm	1056	3604	N/A	N/A	81.0151	437.00	524.40

Tunstall Mirror Radiators - Matt Anthracite							
Size H x W	Watts	BTU	Element Output	Element Type	Code	£ Ex VAT	£ Inc VAT
1800 x 380mm	705	2406	N/A	N/A	81.0168	297.00	356.40
1800 x 500mm	1056	3604	N/A	N/A	81.0169	437.00	524.40

Tunstall Mirror Radiators - Matt Black							
Size H x W	Watts	BTU	Element Output	Element Type	Code	£ Ex VAT	£ Inc VAT
1800 x 380mm	705	2406	N/A	N/A	81.0186	297.00	356.40
1800 x 500mm	1056	3604	N/A	N/A	81.0187	437.00	524.40

#### TECHNICAL INFORMATION

All measurements in Height by Width. Heat output based on  $\Delta T60^{\circ}\text{C}$ . For matching valves see pages 301-309. For indirect heating systems only. Tappings are the width of the rail and approx. 40mm off the wall. Projection from wall 79mm. Mirror width 145mm. Price includes radiator and wall fixing sets, valves extra.



### TUNSTALL DOUBLE MIRROR

**Warranty**  
**5**  
Year

**Heating**

**Technical Tables & Drawings**  
Page 350-351

145mm

Pictured 81.0152 Matt White

Profiles in elliptical shape of this radiator is in perfect harmony with the mirror placed in the middle. Available in two colour options.

#### FEATURES

- Double vertical profile construction, mirror width 145mm
  - Tested to BS EN 442 standards
  - 5 Year manufacturer's warranty\*
  - Not suitable for elements
- \* With conditions

Tunstall Double Mirror Radiators - Matt White							
Size H x W	Watts	BTU	Element Output	Element Type	Code	£ Ex VAT	£ Inc VAT
1800 x 380mm	1102	3761	N/A	N/A	81.0152	357.00	428.40
1800 x 500mm	1654	5645	N/A	N/A	81.0153	531.00	637.20

Tunstall Double Mirror Radiators - Matt Anthracite							
Size H x W	Watts	BTU	Element Output	Element Type	Code	£ Ex VAT	£ Inc VAT
1800 x 380mm	1102	3761	N/A	N/A	81.0170	357.00	428.40
1800 x 500mm	1654	5645	N/A	N/A	81.0171	531.00	637.20

Tunstall Double Mirror Radiators - Matt Black							
Size H x W	Watts	BTU	Element Output	Element Type	Code	£ Ex VAT	£ Inc VAT
1800 x 380mm	1102	3761	N/A	N/A	81.0188	357.00	428.40
1800 x 500mm	1654	5645	N/A	N/A	81.0189	531.00	637.20

#### TECHNICAL INFORMATION

All measurements in Height by Width. Heat output based on  $\Delta T60^{\circ}\text{C}$ . For matching valves see pages 301-309. For indirect heating systems only. Tappings are the width of the rail and approx. 65mm off the wall. Projection from wall 104mm. Mirror width 145mm. Price includes radiator and wall fixing sets, valves extra.



# Designer Range

## DEDDINGTON VERTICAL



Pictured 89.0795 Chrome with 89.0848 Towel Hanger x2



Pictured 89.1522 Matt Cobalt Blue

Bar Dimensions (mm)

Vertical Bars 70 x 11mm

Flat and broad vertical profiles meet the perfect craftsmanship. This vertical model is 1800mm high and available in 5 widths. (3 widths available for Matt Cobalt Blue colour) Towel hangers are same colours and widths as the radiators. (except Matt Cobalt Blue colour)

### Deddington Vertical Radiators - Chrome

Size H x W	Watts	BTU	Element Output	Element Type	Code	£ Ex VAT	£ Inc VAT
1800 x 310mm	493	1683	N/A	N/A	89.0794	481.00	<b>577.20</b>
1800 x 390mm	611	2085	N/A	N/A	89.1523	576.00	<b>691.20</b>
1800 x 470mm	730	2491	N/A	N/A	89.0795	686.00	<b>823.20</b>
1800 x 550mm	846	2887	N/A	N/A	89.1524	758.00	<b>909.60</b>
1800 x 630mm	962	3283	N/A	N/A	89.0796	847.00	<b>1016.40</b>

### Deddington Vertical Radiators - Matt Cobalt Blue

Size H x W	Watts	BTU	Element Output	Element Type	Code	£ Ex VAT	£ Inc VAT
1800 x 310mm	812	2771	N/A	N/A	89.1520	381.00	<b>457.20</b>
1800 x 470mm	1231	4201	N/A	N/A	89.1521	542.00	<b>650.40</b>
1800 x 630mm	1649	5627	N/A	N/A	89.1522	668.00	<b>801.60</b>

### Deddington Towel Hangers - Chrome

Description	Code	£ Ex VAT	£ Inc VAT
310mm	89.0847	62.00	<b>74.40</b>
390mm	89.1540	67.00	<b>80.40</b>
470mm	89.0848	70.00	<b>84.00</b>
550mm	89.1541	73.00	<b>87.60</b>
630mm	89.0849	76.00	<b>91.20</b>

\*Towel hangers are only compatible with Deddington radiators. Radiators projection from wall 160mm when towel hanger is fitted. Max of 2 towel hangers can be fitted.

**Must be fitted before installation.**

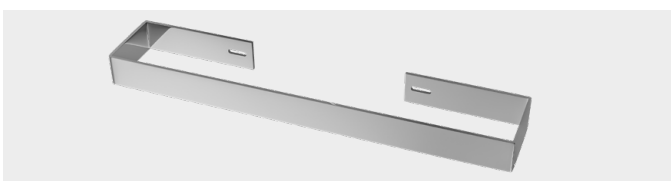

**Technical Tables & Drawings**  
Page 350-351



### FEATURES

- 70 x 11mm vertical bars
- Single profile construction
- Tested to BS EN 442 standards
- 5 Year manufacturer's warranty\*
- Not suitable for elements
- \* With conditions

### TECHNICAL INFORMATION

All measurements in Height by Width. Heat output based on  $\Delta T60^{\circ}C$ . For matching valves see pages 301-309. For indirect heating systems only. Comes with built-in flow diverter. Tappings are the width of the rail and approx. 60mm off the wall. Projection from wall 100mm. Price includes radiator and wall fixing sets, valves extra.

# Designer Range

## DEDDINGTON VERTICAL



Pictured 89.0852 Gloss White with 89.0878 Towel Hanger x1



Pictured 89.0863 Matt Anthracite



Pictured 89.1516 Matt Black with 89.1536 Towel Hangers x2

Deddington Vertical Radiators - Gloss White					
Size H x W	Watts	BTU	Code	£ Ex VAT	£ Inc VAT
1800 x 310mm	812	2771	89.0850	381.00	<b>457.20</b>
1800 x 390mm	1021	3484	89.1511	465.00	<b>558.00</b>
1800 x 470mm	1231	4201	89.0851	542.00	<b>650.40</b>
1800 x 550mm	1440	4914	89.1512	607.00	<b>728.40</b>
1800 x 630mm	1649	5627	89.0852	668.00	<b>801.60</b>

Deddington Vertical Radiators - Matt Anthracite					
Size H x W	Watts	BTU	Code	£ Ex VAT	£ Inc VAT
1800 x 310mm	812	2771	89.0863	381.00	<b>457.20</b>
1800 x 390mm	1021	3484	89.1513	465.00	<b>558.00</b>
1800 x 470mm	1231	4201	89.0864	542.00	<b>650.40</b>
1800 x 550mm	1440	4914	89.1514	607.00	<b>728.40</b>
1800 x 630mm	1649	5627	89.0865	668.00	<b>801.60</b>

Deddington Vertical Radiators - Matt Black					
Size H x W	Watts	BTU	Code	£ Ex VAT	£ Inc VAT
1800 x 310mm	812	2771	89.1515	381.00	<b>457.20</b>
1800 x 390mm	1021	3484	89.1516	465.00	<b>558.00</b>
1800 x 470mm	1231	4201	89.1517	542.00	<b>650.40</b>
1800 x 550mm	1440	4914	89.1518	607.00	<b>728.40</b>
1800 x 630mm	1649	5627	89.1519	668.00	<b>801.60</b>

Deddington Towel Hangers - Gloss White			
Description	Code	£ Ex VAT	£ Inc VAT
310mm	89.0876	60.00	<b>72.00</b>
390mm	89.1531	62.00	<b>74.40</b>
470mm	89.0877	65.00	<b>78.00</b>
550mm	89.1532	68.00	<b>81.60</b>
630mm	89.0878	72.00	<b>86.40</b>

Deddington Towel Hangers - Matt Anthracite			
Description	Code	£ Ex VAT	£ Inc VAT
310mm	89.0879	60.00	<b>72.00</b>
390mm	89.1533	62.00	<b>74.40</b>
470mm	89.0880	65.00	<b>78.00</b>
550mm	89.1534	68.00	<b>81.60</b>
630mm	89.0881	72.00	<b>86.40</b>

Deddington Towel Hangers - Matt Black			
Description	Code	£ Ex VAT	£ Inc VAT
310mm	89.1535	60.00	<b>72.00</b>
390mm	89.1536	62.00	<b>74.40</b>
470mm	89.1537	65.00	<b>78.00</b>
550mm	89.1538	68.00	<b>81.60</b>
630mm	89.1539	72.00	<b>86.40</b>

\*Towel hangers are only compatible with Deddington radiators. Radiators projection from wall 160mm when towel hanger is fitted. Max of 2 towel hangers can be fitted.  
**Must be fitted before installation.**

\*Towel hangers are only compatible with Deddington radiators. Radiators projection from wall 160mm when towel hanger is fitted. Max of 2 towel hangers can be fitted.  
**Must be fitted before installation.**

\*Towel hangers are only compatible with Deddington radiators. Radiators projection from wall 160mm when towel hanger is fitted. Max of 2 towel hangers can be fitted.  
**Must be fitted before installation.**

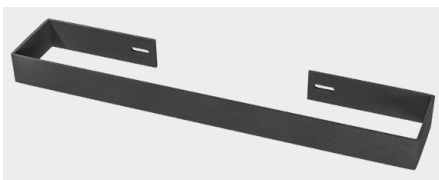
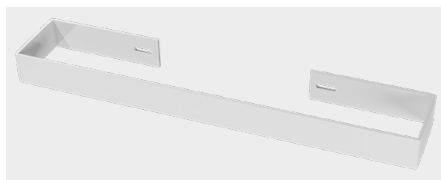

# Designer Range

## DEDDINGTON HORIZONTAL

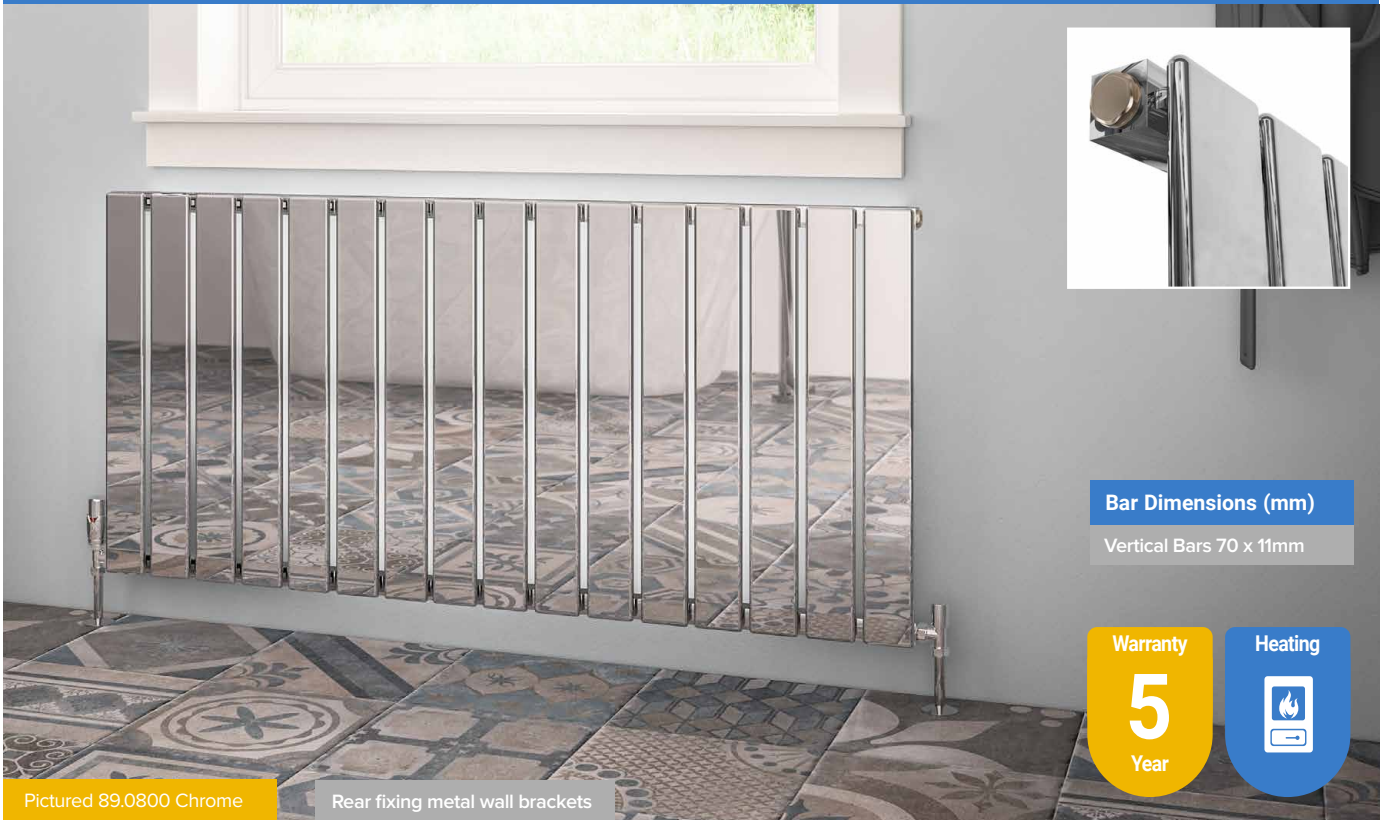

### Bar Dimensions (mm)

Vertical Bars 70 x 11mm

Warranty

5

Year

Heating



Pictured 89.0800 Chrome

Rear fixing metal wall brackets

Flat and broad vertical profiles meet the perfect craftsmanship. This horizontal model is available in 600mm height and 4 widths. This beautifully finished radiator will have all the attention in the room.

### FEATURES

- 70 x 11mm vertical bars
- Rear fixing metal wall brackets
- Single profile construction
- Tested to BS EN 442 standards
- 5 Year manufacturer's warranty\*
- Not suitable for elements
- \* With conditions

### Technical Tables & Drawings

Page 352-353



### Deddington Horizontal Radiators - Chrome

Size H x W	Watts	BTU	Element Output	Element Type	Code	£ Ex VAT	£ Inc VAT
600 x 390mm	249	850	N/A	N/A	89.1507	272.00	326.40
600 x 470mm	296	1010	N/A	N/A	89.1508	319.00	382.80
600 x 550mm	343	1171	N/A	N/A	89.1509	362.00	434.40
600 x 630mm	390	1331	N/A	N/A	89.0797	409.00	490.80
600 x 790mm	483	1648	N/A	N/A	89.0798	489.00	586.80
600 x 950mm	574	1959	N/A	N/A	89.0799	553.00	663.60
600 x 1110mm	664	2266	N/A	N/A	89.1510	593.00	711.60
600 x 1270mm	755	2577	N/A	N/A	89.0800	627.00	752.40

### TECHNICAL INFORMATION

All measurements in Height by Width. Heat output based on  $\Delta T60^{\circ}\text{C}$ . For matching valves see pages 301-309. For indirect heating systems only. Comes with built-in flow diverter. Tappings are the width of the rail and approx. 60mm off the wall. Projection from wall 100mm. Price includes radiator and wall fixing sets, valves extra.

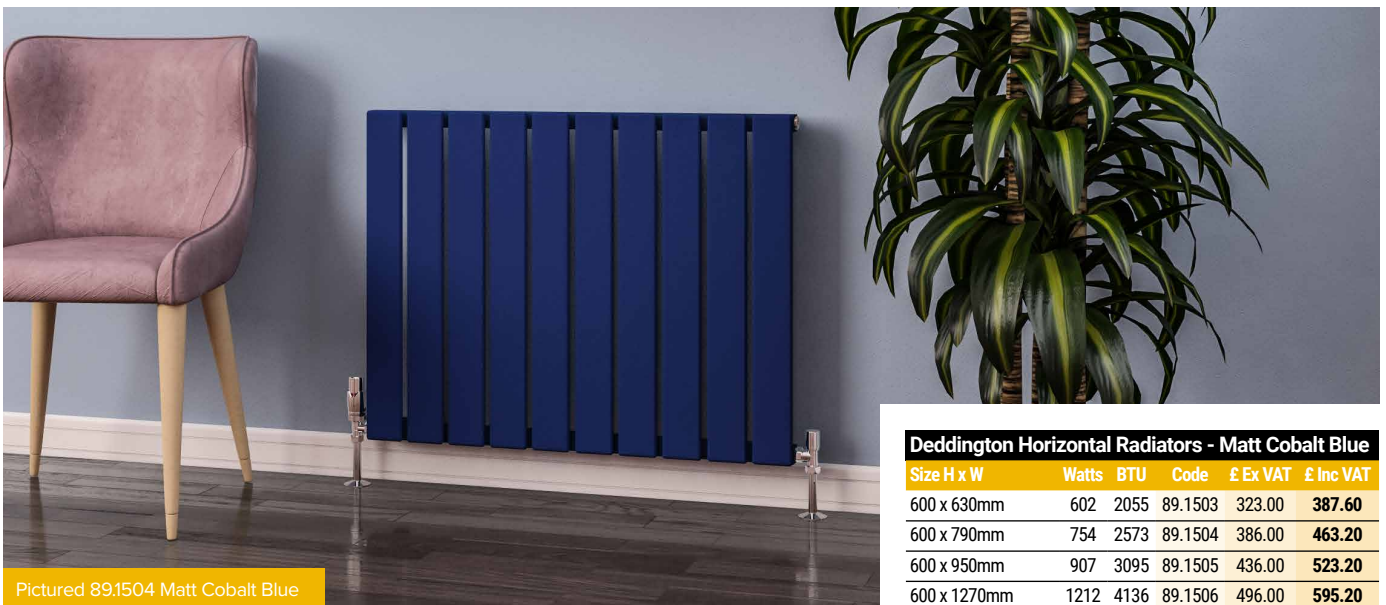

Pictured 89.1504 Matt Cobalt Blue

### Deddington Horizontal Radiators - Matt Cobalt Blue

Size H x W	Watts	BTU	Code	£ Ex VAT	£ Inc VAT
600 x 630mm	602	2055	89.1503	323.00	387.60
600 x 790mm	754	2573	89.1504	386.00	463.20
600 x 950mm	907	3095	89.1505	436.00	523.20
600 x 1270mm	1212	4136	89.1506	496.00	595.20

# Designer Range

## DEDDINGTON HORIZONTAL



Pictured 89.0855 Gloss White

### Deddington Horizontal Radiators - Gloss White

Size H x W	Watts	BTU	Code	£ Ex VAT	£ Inc VAT
600 x 390mm	373	1273	89.1491	217.00	260.40
600 x 470mm	449	1532	89.1492	255.00	306.00
600 x 550mm	525	1792	89.1493	289.00	346.80
600 x 630mm	602	2055	89.0853	323.00	387.60
600 x 790mm	754	2573	89.0854	386.00	463.20
600 x 950mm	907	3095	89.0855	436.00	523.20
600 x 1110mm	1059	3614	89.1494	474.00	568.80
600 x 1270mm	1212	4136	89.0856	496.00	595.20



Pictured 89.0867 Matt Anthracite

### Deddington Horizontal Radiators - Matt Anthracite

Size H x W	Watts	BTU	Code	£ Ex VAT	£ Inc VAT
600 x 390mm	373	1273	89.1495	217.00	260.40
600 x 470mm	449	1532	89.1496	255.00	306.00
600 x 550mm	525	1792	89.1497	289.00	346.80
600 x 630mm	602	2055	89.0866	323.00	387.60
600 x 790mm	754	2573	89.0867	386.00	463.20
600 x 950mm	907	3095	89.0868	436.00	523.20
600 x 1110mm	1059	3614	89.1498	474.00	568.80
600 x 1270mm	1212	4136	89.0869	496.00	595.20



Pictured 89.1499 Matt Black

Magnetic Towel Hangers  
Page 145



### Deddington Horizontal Radiators - Matt Black

Size H x W	Watts	BTU	Code	£ Ex VAT	£ Inc VAT
600 x 630mm	602	2055	89.1499	323.00	387.60
600 x 790mm	754	2573	89.1500	386.00	463.20
600 x 950mm	907	3095	89.1501	436.00	523.20
600 x 1270mm	1212	4136	89.1502	496.00	595.20

# Designer Range

## DEDDINGTON TOWEL RAILS



Pictured 89.0804 Chrome

Rear fixing metal wall brackets

A designer towel rail in 5 finishes and with broad horizontal bars that is available in 3 heights and 2 widths.

### FEATURES

- 70 x 11mm horizontal bars
  - Rear fixing metal wall brackets
  - Stunning chrome surface
  - Single profile construction
  - Tested to BS EN 442 standards
  - 5 Year manufacturer's warranty\*
  - Can be single, dual fuel or all electric
- \* With conditions

**Technical Tables  
& Drawings**  
Page 352-353



Pictured 89.0805 Chrome

Warranty

**5**

Year

Heating

All Electric

Dual-Fuel

### Deddington Towel Rails - Chrome

Size H x W	Watts	BTU	Element Output	Element Type	Code	£ Ex VAT	£ Inc VAT
800 x 500mm	320	1092	150W	A, A+, D, E, F, G	89.0801	364.00	436.80
800 x 600mm	368	1256	150W	A, A+, D, E, F, G	89.0802	401.00	481.20
1200 x 500mm	457	1560	300W	A, A+, D, E, F, G	89.0803	474.00	568.80
1200 x 600mm	525	1792	300W	A, A+, D, E, F, G	89.0804	520.00	624.00
1800 x 500mm	646	2205	300W	A, A+, D, E, F, G	89.0805	676.00	811.20
1800 x 600mm	743	2536	450W	A, A+, D, E, F, G	89.0806	743.00	891.60

### TECHNICAL INFORMATION

All measurements in Height by Width. Heat output based on  $\Delta T60^{\circ}\text{C}$ . Radiators that are electric only are restricted to the heat output of the elements. Element size can be increased to full capacity of rail if using element type D, E, F or G. (Type F & G Elements suitable for all electric only) For element types see pages 288-300. For matching valves see pages 301-309. For indirect heating systems only. Tappings are 30mm less than the width of the rail and approx. 60mm off the wall. Projection from wall 100mm. Price includes radiator and wall fixing sets, valves extra.

**Round Vent Caps**  
Page 313





# Designer Range

## DEDDINGTON TOWEL RAILS



Pictured 89.1528 Matt Cobalt Blue



Pictured 89.0871 Matt Anthracite

### Deddington Towel Rails - Gloss White

Size H x W	Watts	BTU	Element Output	Element Type	Code	£ Ex VAT	£ Inc VAT
800 x 500mm	509	1737	150W	A, A+, D, E, F, G	89.0857	311.00	373.20
800 x 600mm	591	2017	300W	A, A+, D, E, F, G	89.0858	343.00	411.60
1200 x 500mm	725	2474	300W	A, A+, D, E, F, G	89.0859	404.00	484.80
1200 x 600mm	843	2877	300W	A, A+, D, E, F, G	89.0860	445.00	534.00
1800 x 500mm	1031	3518	450W	A, A+, D, E, F, G	89.0861	576.00	691.20
1800 x 600mm	1199	4091	450W	A, A+, D, E, F, G	89.0862	634.00	760.80

### Deddington Towel Rails - Matt Anthracite

Size H x W	Watts	BTU	Element Output	Element Type	Code	£ Ex VAT	£ Inc VAT
800 x 500mm	509	1737	150W	A, A+, D, E, F, G	89.0870	311.00	373.20
800 x 600mm	591	2017	300W	A, A+, D, E, F, G	89.0871	343.00	411.60
1200 x 500mm	725	2474	300W	A, A+, D, E, F, G	89.0872	404.00	484.80
1200 x 600mm	843	2877	300W	A, A+, D, E, F, G	89.0873	445.00	534.00
1800 x 500mm	1031	3518	450W	A, A+, D, E, F, G	89.0874	576.00	691.20
1800 x 600mm	1199	4091	450W	A, A+, D, E, F, G	89.0875	634.00	760.80

### Deddington Towel Rails - Matt Black

Size H x W	Watts	BTU	Element Output	Element Type	Code	£ Ex VAT	£ Inc VAT
800 x 500mm	509	1737	150W	A, A+, D, E, F, G	89.1525	311.00	373.20
1200 x 500mm	725	2474	300W	A, A+, D, E, F, G	89.1526	404.00	484.80
1800 x 500mm	1031	3518	450W	A, A+, D, E, F, G	89.1527	576.00	691.20

### Deddington Towel Rails - Matt Cobalt Blue

Size H x W	Watts	BTU	Element Output	Element Type	Code	£ Ex VAT	£ Inc VAT
800 x 500mm	509	1737	150W	A, A+, D, E, F, G	89.1528	311.00	373.20
1200 x 500mm	725	2474	300W	A, A+, D, E, F, G	89.1529	404.00	484.80
1800 x 500mm	1031	3518	450W	A, A+, D, E, F, G	89.1530	576.00	691.20

### 800mm High



### 1800mm High



### 1200mm High



### Radiator Valves

Page 301-309



# Designer Range

## ADDINGTON TYPE 10 - GLOSS WHITE



Pictured 91.0015 Gloss White (Fitted Vertically) & 91.0081 x2 Towel Hangers

Technical Tables  
& Drawings  
Page 352-353



Bar Dimensions (mm)

Vertical Bars 70 x 11mm

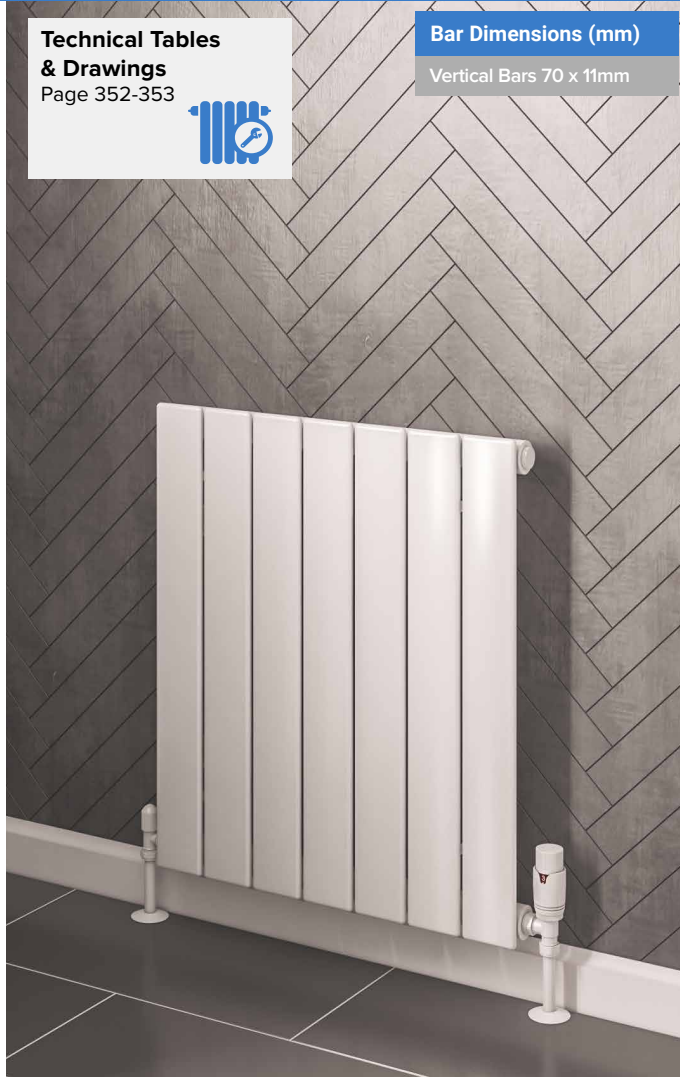

Pictured 91.0003 Gloss White (Fitted Vertically)



Towel Hangers  
Page 149



Round Vent Caps  
Page 313



Warranty  
**5**  
Year

Heating

All Electric

Dual-Fuel

Pictured 91.0134 Gloss White (Fitted Vertically)

HEATING NOTE:  
Radiators that are electric only are restricted to the heat output of the elements.

# Designer Range

## ADDINGTON TYPE 10 - GLOSS WHITE

A designer radiator range available to fit both vertically and horizontally designs in a gloss white finishes. Optional extras include flat style and double flat style towel hangers (see Page 591).

### FEATURES

- Tested to BS EN 442 standards
  - Single profile construction
  - Maximum corrosion resistance
  - Cataphoretic painting technology
  - Can be installed vertically or horizontally
  - Can be single, dual fuel or all electric (not all sizes)
  - 5 Year Manufacturer's Warranty\*
- \* With conditions

### 500mm Height

#### Addington Type 10 Vertical / Horizontal Radiators - Gloss White

Size H x W	Watts	BTU	Element Output	Element Type	Code	£ Ex VAT	£ Inc VAT
500 x 514mm	414	1413	150W	A, A+, C, E, H	91.0001	276.00	331.20
500 x 588mm	473	1614	300W	A, A+, C, E, H	91.0002	303.00	363.60

### 600mm Height

#### Addington Type 10 Vertical / Horizontal Radiators - Gloss White

Size H x W	Watts	BTU	Element Output	Element Type	Code	£ Ex VAT	£ Inc VAT
600 x 292mm	281	958	150W	A, A+	91.0127	216.00	259.20
600 x 366mm	351	1198	150W	A, A+	91.0128	243.00	291.60
600 x 440mm	421	1438	150W	A, A+, C, E, H	91.0129	268.00	321.60
600 x 514mm	492	1679	300W	A, A+, C, E, H	91.0003	297.00	356.40
600 x 588mm	562	1918	300W	A, A+, C, E, H	91.0004	322.00	386.40
600 x 662mm	632	2157	300W	A, A+, C, E, H	91.0130	351.00	421.20
600 x 810mm	772	2636	450W	A+, C, E, H	91.0131	402.00	482.40
600 x 1032mm	983	3355	600W	A, A+, C, E, H	91.0132	486.00	583.20
600 x 1180mm	1124	3834	600W	A, A+, C, E, H	91.0133	540.00	648.00
600 x 1254mm	1194	4073	600W	A, A+, C, E, H	91.0134	565.00	678.00

### 800mm Height

#### Addington Type 10 Vertical / Horizontal Radiators - Gloss White

Size H x W	Watts	BTU	Element Output	Element Type	Code	£ Ex VAT	£ Inc VAT
800 x 514mm	642	2191	300W	A, A+, C, H	91.0005	331.00	397.20
800 x 588mm	733	2501	450W	A, A+, C, H	91.0006	364.00	436.80

### 1000mm Height

#### Addington Type 10 Vertical / Horizontal Radiators - Gloss White

Size H x W	Watts	BTU	Element Output	Element Type	Code	£ Ex VAT	£ Inc VAT
1000 x 514mm	786	2682	450W	A, A+, C, H	91.0007	368.00	441.60
1000 x 588mm	898	3064	450W	A, A+, C, H	91.0008	402.00	482.40

### 1200mm Height

#### Addington Type 10 Vertical / Horizontal Radiators - Gloss White

Size H x W	Watts	BTU	Element Output	Element Type	Code	£ Ex VAT	£ Inc VAT
1200 x 514mm	923	3149	450W	A, A+, C, H	91.0009	402.00	482.40
1200 x 588mm	1055	3600	600W	A+, C, H	91.0010	446.00	535.20

### 1400mm Height

#### Addington Type 10 Vertical / Horizontal Radiators - Gloss White

Size H x W	Watts	BTU	Element Output	Element Type	Code	£ Ex VAT	£ Inc VAT
1400 x 514mm	1055	3600	600W	A+, C, H	91.0011	441.00	529.20
1400 x 588mm	1206	4115	600W	A+, C, H	91.0012	486.00	583.20

### 1800mm Height

#### Addington Type 10 Vertical / Horizontal Radiators - Gloss White

Size H x W	Watts	BTU	Element Output	Element Type	Code	£ Ex VAT	£ Inc VAT
1800 x 292mm	744	2539	N/A	N/A	91.0013	335.00	402.00
1800 x 366mm	931	3177	N/A	N/A	91.0014	397.00	476.40
1800 x 440mm	1117	3811	450W	A, A+	91.0015	453.00	543.60
1800 x 514mm	1303	4446	600W	A+	91.0016	509.00	610.80
1800 x 588mm	1489	5080	600W	A+	91.0017	569.00	682.80



Pictured 91.0014 Gloss White (Fitted Horizontally)

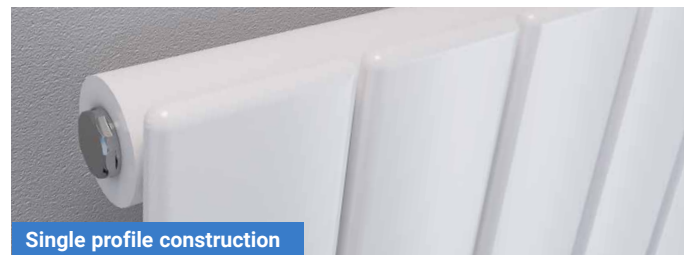

Single profile construction

Radiator can be installed vertically or horizontally using the pre-fitted wall bracket holders. (Below images)



### TECHNICAL INFORMATION

All measurements in Height by Width. Heat output based on  $\Delta T60^{\circ}\text{C}$ . Radiators that are electric only are restricted to the heat output of the elements. Element size can be increased to full capacity of rail if using element type C, E or H. For element types see pages 288-300. For matching valves see pages 301-309. Comes with pre-fitted flow diverter (except 500 & 600mm heights). Flow diverter must remain in place when radiator installed on central heating system (only for vertical installations). For indirect heating systems only. **In vertical installation**, tappings are the width of the rail and approx. 40mm off the wall. **In horizontal installation**, tappings are approx. 50mm less than the width of the rail and approx. 40mm off the wall. Price includes radiator and wall fixing sets, valves extra.

### MAGNETIC TOWEL HANGERS



#### Round Magnetic Towel Hangers

Size	Colour	Code	£ Ex VAT	£ Inc VAT
600mm	Gloss White	101.0071	96.00	115.20
600mm	Chrome	101.0072	102.00	122.40



#### Square Magnetic Towel Hangers

Size	Colour	Code	£ Ex VAT	£ Inc VAT
600mm	Gloss White	101.0073	97.00	116.40
600mm	Chrome	101.0074	109.00	130.80

Both Round & Square towel hangers come in three unassembled pieces. Please cut 600mm bar to required column-to-column length. Holds up to 5kg weight.

# Designer Range

## ADDINGTON TYPE 10 - MATT ANTHRACITE



Pictured 91.0032 Matt Anthracite (Fitted Vertically) & 91.0111 Towel Hanger

Technical Tables  
& Drawings  
Page 352-353



Bar Dimensions (mm)

Vertical Bars 70 x 11mm

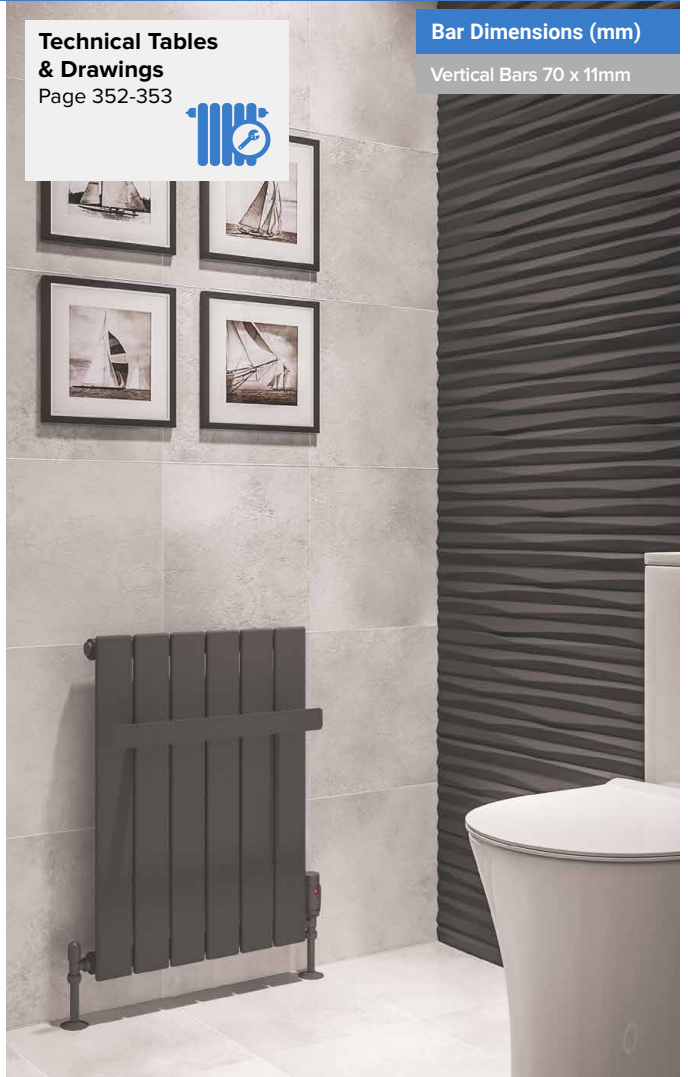

Pictured 91.0147 Matt Anthracite (Fitted Vertically) & 91.0086 Towel Hanger

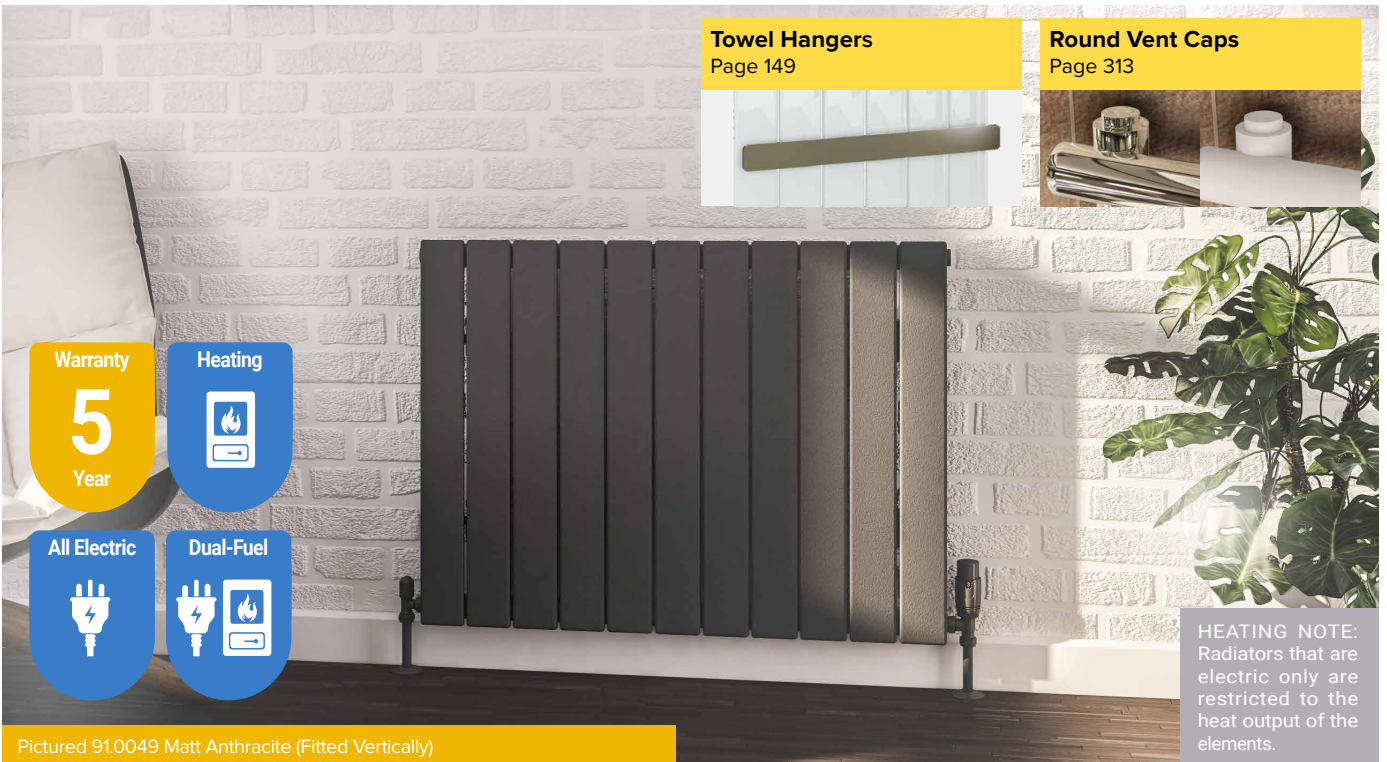

Towel Hangers  
Page 149

Round Vent Caps  
Page 313

Warranty  
**5**  
Year

Heating

All Electric

Dual-Fuel

Pictured 91.0049 Matt Anthracite (Fitted Vertically)

HEATING NOTE:  
Radiators that are electric only are restricted to the heat output of the elements.

# Designer Range

## ADDINGTON TYPE 10 - MATT ANTHRACITE

A designer radiator range available to fit both vertically and horizontally designs in a matt anthracite finish. Optional extras include flat style and double flat style towel hangers (see Page 591).

### FEATURES

- Tested to BS EN 442 standards
- Single profile construction
- Maximum corrosion resistance
- Cataphoretic painting technology
- Can be installed vertically or horizontally
- Can be single, dual fuel or all electric (not all sizes)
- 5 Year Manufacturer's Warranty\*

\* With conditions

### 500mm Height

#### Addington Type 10 Vertical / Horizontal Radiators - Matt Anthracite

Size H x W	Watts	BTU	Element Output	Element Type	Code	£ Ex VAT	£ Inc VAT
500 x 514mm	414	1413	150W	A, A+, C, E, H	91.0018	276.00	331.20
500 x 588mm	473	1614	300W	A, A+, C, E, H	91.0019	303.00	363.60

### 600mm Height

#### Addington Type 10 Vertical / Horizontal Radiators - Matt Anthracite

Size H x W	Watts	BTU	Element Output	Element Type	Code	£ Ex VAT	£ Inc VAT
600 x 292mm	281	958	150W	A, A+	91.0145	216.00	259.20
600 x 366mm	351	1198	150W	A, A+	91.0146	243.00	291.60
600 x 440mm	421	1438	150W	A, A+, C, E, H	91.0147	268.00	321.60
600 x 514mm	492	1679	300W	A, A+, C, E, H	91.0020	297.00	356.40
600 x 588mm	562	1918	300W	A, A+, C, E, H	91.0021	322.00	386.40
600 x 662mm	632	2157	300W	A, A+, C, E, H	91.0148	351.00	421.20
600 x 810mm	772	2636	450W	A+, C, E, H	91.0149	402.00	482.40
600 x 1032mm	983	3355	600W	A, A+, C, E, H	91.0150	486.00	583.20
600 x 1180mm	1124	3834	600W	A, A+, C, E, H	91.0151	540.00	648.00
600 x 1254mm	1194	4073	600W	A, A+, C, E, H	91.0152	565.00	678.00

### 800mm Height

#### Addington Type 10 Vertical / Horizontal Radiators - Matt Anthracite

Size H x W	Watts	BTU	Element Output	Element Type	Code	£ Ex VAT	£ Inc VAT
800 x 514mm	642	2191	300W	A, A+, C, H	91.0022	331.00	397.20
800 x 588mm	733	2501	450W	A, A+, C, H	91.0023	364.00	436.80

### 1000mm Height

#### Addington Type 10 Vertical / Horizontal Radiators - Matt Anthracite

Size H x W	Watts	BTU	Element Output	Element Type	Code	£ Ex VAT	£ Inc VAT
1000 x 514mm	786	2682	450W	A, A+, C, H	91.0024	368.00	441.60
1000 x 588mm	898	3064	450W	A, A+, C, H	91.0025	402.00	482.40

### 1200mm Height

#### Addington Type 10 Vertical / Horizontal Radiators - Matt Anthracite

Size H x W	Watts	BTU	Element Output	Element Type	Code	£ Ex VAT	£ Inc VAT
1200 x 514mm	923	3149	450W	A, A+, C, H	91.0026	402.00	482.40
1200 x 588mm	1055	3600	600W	A+, C, H	91.0027	446.00	535.20

### 1400mm Height

#### Addington Type 10 Vertical / Horizontal Radiators - Matt Anthracite

Size H x W	Watts	BTU	Element Output	Element Type	Code	£ Ex VAT	£ Inc VAT
1400 x 514mm	1055	3600	600W	A+, C, H	91.0028	441.00	529.20
1400 x 588mm	1206	4115	600W	A+, C, H	91.0029	486.00	583.20

### 1800mm Height

#### Addington Type 10 Vertical / Horizontal Radiators - Matt Anthracite

Size H x W	Watts	BTU	Element Output	Element Type	Code	£ Ex VAT	£ Inc VAT
1800 x 292mm	744	2539	N/A	N/A	91.0030	335.00	402.00
1800 x 366mm	931	3177	N/A	N/A	91.0031	397.00	476.40
1800 x 440mm	1117	3811	450W	A, A+	91.0032	453.00	543.60
1800 x 514mm	1303	4446	600W	A+	91.0033	509.00	610.80
1800 x 588mm	1489	5080	600W	A+	91.0034	569.00	682.80



Pictured 91.0032 (Fitted Horizontally)

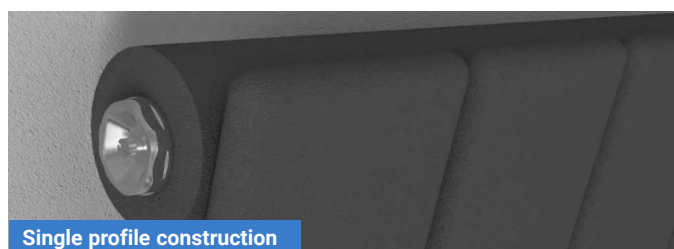

Single profile construction

Radiator can be installed vertically or horizontally using the pre-fitted wall bracket holders. (Below images)

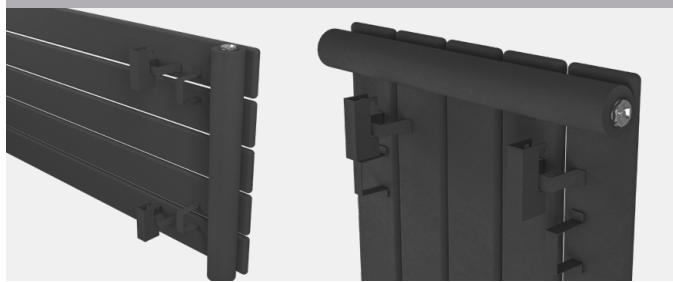

### TECHNICAL INFORMATION

All measurements in Height by Width. Heat output based on  $\Delta T60^{\circ}\text{C}$ . Radiators that are electric only are restricted to the heat output of the elements. Element size can be increased to full capacity of rail if using element type C, E or H. For element types see pages 288-300. For matching valves see pages 301-309. Comes with pre-fitted flow diverter (except 500 & 600mm heights). Flow diverter must remain in place when radiator installed on central heating system (only for vertical installations). For indirect heating systems only. In vertical installation, tappings are the width of the rail and approx. 40mm off the wall. In horizontal installation, tappings are approx. 50mm less than the width of the rail and approx. 40mm off the wall. Price includes radiator and wall fixing sets, valves extra.

### MAGNETIC TOWEL HANGERS



#### Round Magnetic Towel Hangers

Size	Colour	Code	£ Ex VAT	£ Inc VAT
600mm	Gloss White	101.0071	96.00	115.20
600mm	Chrome	101.0072	102.00	122.40



#### Square Magnetic Towel Hangers

Size	Colour	Code	£ Ex VAT	£ Inc VAT
600mm	Gloss White	101.0073	97.00	116.40
600mm	Chrome	101.0074	109.00	130.80

Both Round & Square towel hangers come in three unassembled pieces. Please cut 600mm bar to required column-to-column length. Holds up to 5kg weight.

# Designer Range

## ADDINGTON TYPE 10 - TOWEL RAILS



Pictured 91.0065 Gloss White

A designer towel rail available in 3 heights and 2 widths in gloss white, matt anthracite colours.

### FEATURES

- Tested to BS EN 442 standards
  - Single profile construction
  - Maximum corrosion resistance
  - Cathaphoretic painting technology
  - Can be installed vertically or horizontally
  - Can be single, dual fuel or all electric
  - 5 Year Manufacturer's Warranty\*
- \* With conditions

**Technical Tables & Drawings**  
Page 352-353



### TECHNICAL INFORMATION

All measurements in Height by Width. Heat output based on  $\Delta T60^{\circ}\text{C}$ . Radiators that are electric only are restricted to the heat output of the elements. Element size can be increased to full capacity of rail if using element type D, E, F or G. (Type F & G Elements suitable for all electric only) For element types see pages 288-300. For matching valves see pages 301-309. For indirect heating systems only. Tappings are 50mm less than the width of the rail and approx. 40mm off the wall. Price includes radiator and wall fixing sets, valves extra.

Warranty

**5**

Year

Heating

All Electric

Dual-Fuel

### 790mm High

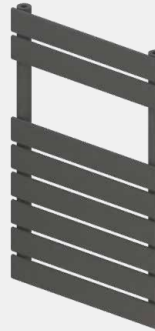

### 1750mm High



### 1110mm High



### Addington Type 10 Towel Rails - Gloss White

Size H x W	Watts	BTU	Element Output	Element Type	Code	£ Ex VAT	£ Inc VAT
790 x 400mm	374	1276	150W	A, A+, D, E, F, G	91.0061	278.00	<b>333.60</b>
790 x 500mm	467	1593	150W	A, A+, D, E, F, G	91.0064	321.00	<b>385.20</b>
790 x 600mm	560	1911	300W	A, A+, D, E, F, G	91.0067	363.00	<b>435.60</b>
1110 x 400mm	492	1679	300W	A, A+, D, E, F, G	91.0062	412.00	<b>494.40</b>
1110 x 500mm	610	2081	300W	A, A+, D, E, F, G	91.0065	431.00	<b>517.20</b>
1110 x 600mm	731	2494	450W	A, A+, D, E, F, G	91.0068	448.00	<b>537.60</b>
1750 x 400mm	729	2487	450W	A, A+, D, E, F, G	91.0063	588.00	<b>705.60</b>
1750 x 500mm	885	3020	450W	A, A+, D, E, F, G	91.0066	613.00	<b>735.60</b>
1750 x 600mm	1062	3624	600W	A, A+, D, E, F, G	91.0069	639.00	<b>766.80</b>

### Addington Type 10 Towel Rails - Matt Anthracite

Size H x W	Watts	BTU	Element Output	Element Type	Code	£ Ex VAT	£ Inc VAT
790 x 400mm	374	1276	150W	A, A+, D, E, F, G	91.0070	278.00	<b>333.60</b>
790 x 500mm	467	1593	150W	A, A+, D, E, F, G	91.0073	321.00	<b>385.20</b>
790 x 600mm	560	1911	300W	A, A+, D, E, F, G	91.0076	363.00	<b>435.60</b>
1110 x 400mm	492	1679	300W	A, A+, D, E, F, G	91.0071	412.00	<b>494.40</b>
1110 x 500mm	610	2081	300W	A, A+, D, E, F, G	91.0074	431.00	<b>517.20</b>
1110 x 600mm	731	2494	450W	A, A+, D, E, F, G	91.0077	448.00	<b>537.60</b>
1750 x 400mm	729	2487	450W	A, A+, D, E, F, G	91.0072	588.00	<b>705.60</b>
1750 x 500mm	885	3020	450W	A, A+, D, E, F, G	91.0075	613.00	<b>735.60</b>
1750 x 600mm	1062	3624	600W	A, A+, D, E, F, G	91.0078	639.00	<b>766.80</b>

**Radiator Valves**  
Page 301-309



**Round Vent Caps**  
Page 313



# Designer Range

## ADDINGTON TYPE 10 ADDINGTON ALUMINIUM TYPE 10 SINGLE FLAT STYLE TOWEL HANGERS



Type 10 - Single Flat Style Towel Hangers - Gloss White			
Description	Code	£ Ex VAT	£ Inc VAT
Towel Hanger 292mm	91.0079	65.00	<b>78.00</b>
Towel Hanger 366mm	91.0080	66.00	<b>79.20</b>
Towel Hanger 440mm	91.0081	67.00	<b>80.40</b>
Towel Hanger 514mm	91.0082	69.00	<b>82.80</b>
Towel Hanger 588mm	91.0083	69.00	<b>82.80</b>

## ADDINGTON TYPE 10 ADDINGTON ALUMINIUM TYPE 10 DOUBLE FLAT STYLE TOWEL HANGERS



Type 10 - Double Flat Style Towel Hangers - Gloss White			
Description	Code	£ Ex VAT	£ Inc VAT
Towel Hanger 292mm	91.0099	79.00	<b>94.80</b>
Towel Hanger 366mm	91.0100	81.00	<b>97.20</b>
Towel Hanger 440mm	91.0101	84.00	<b>100.80</b>
Towel Hanger 514mm	91.0102	86.00	<b>103.20</b>
Towel Hanger 588mm	91.0103	88.00	<b>105.60</b>

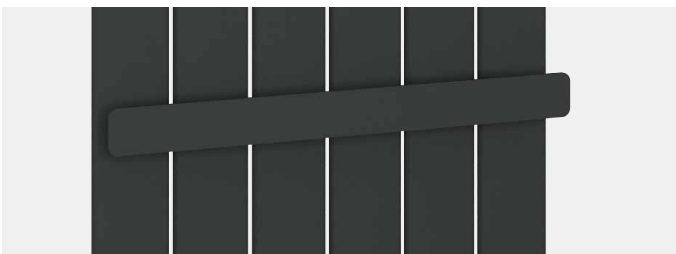

Type 10 - Single Flat Style Towel Hangers - Matt Anthracite			
Description	Code	£ Ex VAT	£ Inc VAT
Towel Hanger 292mm	91.0084	65.00	<b>78.00</b>
Towel Hanger 366mm	91.0085	66.00	<b>79.20</b>
Towel Hanger 440mm	91.0086	67.00	<b>80.40</b>
Towel Hanger 514mm	91.0087	69.00	<b>82.80</b>
Towel Hanger 588mm	91.0088	69.00	<b>82.80</b>



Type 10 - Double Flat Style Towel Hangers - Matt Anthracite			
Description	Code	£ Ex VAT	£ Inc VAT
Towel Hanger 292mm	91.0104	79.00	<b>94.80</b>
Towel Hanger 366mm	91.0105	81.00	<b>97.20</b>
Towel Hanger 440mm	91.0106	84.00	<b>100.80</b>
Towel Hanger 514mm	91.0107	86.00	<b>103.20</b>
Towel Hanger 588mm	91.0108	88.00	<b>105.60</b>



Type 10 - Single Flat Style Towel Hangers - Chrome			
Description	Code	£ Ex VAT	£ Inc VAT
Towel Hanger 292mm	91.0089	98.00	<b>117.60</b>
Towel Hanger 366mm	91.0090	100.00	<b>120.00</b>
Towel Hanger 440mm	91.0091	102.00	<b>122.40</b>
Towel Hanger 514mm	91.0092	103.00	<b>123.60</b>
Towel Hanger 588mm	91.0093	107.00	<b>128.40</b>



Type 10 - Double Flat Style Towel Hangers - Chrome			
Description	Code	£ Ex VAT	£ Inc VAT
Towel Hanger 292mm	91.0109	124.00	<b>148.80</b>
Towel Hanger 366mm	91.0110	130.00	<b>156.00</b>
Towel Hanger 440mm	91.0111	132.00	<b>158.40</b>
Towel Hanger 514mm	91.0112	135.00	<b>162.00</b>
Towel Hanger 588mm	91.0113	138.00	<b>165.60</b>

**TECHNICAL DETAILS**

The Single Flat Style Towel Hanger is compatible with both vertical and horizontal installation.

**MUST BE FITTED BEFORE INSTALLATION!**

Radiators projection from wall 119mm when towel hangers is fitted.



**TECHNICAL DETAILS**

The Double Flat Style Towel Hanger is compatible with vertical installation only.

**MUST BE FITTED BEFORE INSTALLATION!**

Radiators projection from wall 119mm when towel hangers is fitted.



**Installation Note:** Single Flat Style Towel Hangers are not compatible with Deddington Vertical & Deddington Horizontal radiators.

**Installation Note:** Double Flat Style Towel Hangers are not compatible with Deddington Vertical & Deddington Horizontal radiators.

# Designer Range

## ADDINGTON TYPE 20 - GLOSS WHITE



Pictured 91.0037 Gloss White (Fitted Vertically)

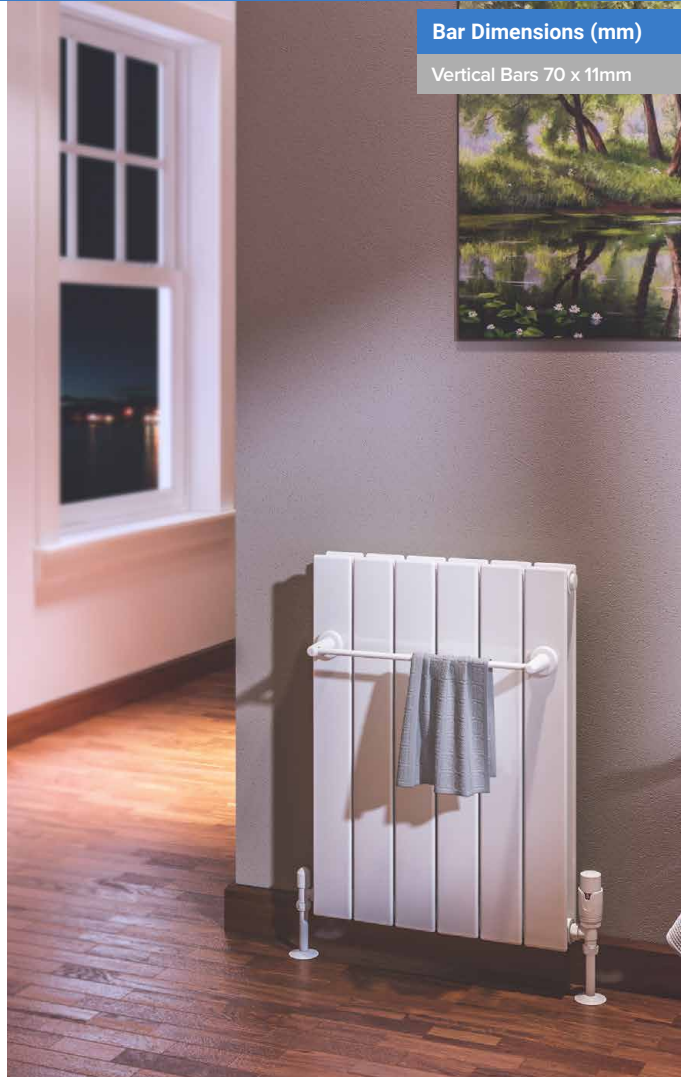

Bar Dimensions (mm)

Vertical Bars 70 x 11mm

Pictured 91.0137 Gloss White (Fitted Vertically) with 101.0071 Towel Hanger



HEATING NOTE:  
Radiators that are electric only are restricted to the heat output of the elements.

Warranty

**5**

Year

Heating

All Electric

Dual-Fuel

Pictured 91.0143 (Fitted Vertically)



# Designer Range

## ADDINGTON TYPE 20 - GLOSS WHITE

A designer radiator range available to fit both vertically and horizontally designs in a gloss white finish.

### FEATURES

- Tested to BS EN 442 standards
- Double profile construction
- Maximum corrosion resistance
- Cataphoretic painting technology
- Can be installed vertically or horizontally
- Can be single, dual fuel or all electric
- 5 Year Manufacturer's Warranty\*
- \* With conditions

**Technical Tables  
& Drawings**  
Page 354-355



### 600mm Height

#### Addington Type 20 Vertical / Horizontal Radiators - Gloss White

Size H x W	Watts	BTU	Element Output	Element Type	Code	£ Ex VAT	£ Inc VAT
600 x 292mm	401	1369	150W	A, A+	91.0135	297.00	356.40
600 x 366mm	502	1712	300W	A, A+	91.0136	341.00	409.20
600 x 440mm	602	2054	300W	A, A+, C, H	91.0137	387.00	464.40
600 x 514mm	702	2396	300W	A, A+, C, H	91.0138	434.00	520.80
600 x 588mm	803	2738	450W	A, A+, C, H	91.0139	483.00	579.60
600 x 662mm	903	3081	450W	A, A+, C, H	91.0140	530.00	636.00
600 x 810mm	1104	3765	600W	A, A+, C, E, H	91.0141	622.00	746.40
600 x 1032mm	1405	4792	750W	A, A+, C, E, H	91.0142	766.00	919.20
600 x 1180mm	1605	5477	900W	A, A+, C, E, H	91.0143	858.00	1029.60
600 x 1254mm	1706	5819	1000W	A, A+, C, E, H	91.0144	905.00	1086.00

### 1800mm Height

#### Addington Type 20 Vertical / Horizontal Radiators - Gloss White

Size H x W	Watts	BTU	Element Output	Element Type	Code	£ Ex VAT	£ Inc VAT
1800 x 366mm	1329	4535	300W	A, A+	91.0035	676.00	811.20
1800 x 440mm	1595	5442	450W	A, A+	91.0036	800.00	960.00
1800 x 514mm	1861	6350	600W	A+	91.0037	924.00	1108.80
1800 x 588mm	2127	7257	600W	A+	91.0038	1048.00	1257.60

### TECHNICAL INFORMATION

All measurements in Height by Width. Heat output based on  $\Delta T 60^{\circ}\text{C}$ . Radiators that are electric only are restricted to the heat output of the elements. Element size can be increased to full capacity of rail if using element type C, E or H. For element types see pages 288-300. For matching valves see pages 301-309. Comes with pre-fitted flow diverter (except 500 & 600mm heights). Flow diverter must remain in place when radiator installed on central heating system (only for vertical installations). For indirect heating systems only. In vertical installation, tappings are the width of the rail and approx. 64mm off the wall. In horizontal installation, tappings are approx. 50mm less than the width of the rail and approx. 64mm off the wall. Price includes radiator and wall fixing sets, valves extra.

### Multi-Purpose Towel Hangers

Page 312



### Radiator Valves

Page 301-309



### Round Vent Caps

Page 313



Pictured 91.0037 (Fitted Horizontally)



Double profile construction

Radiator can be installed vertically or horizontally using the pre-fitted wall bracket holders. (Below images)



### MAGNETIC TOWEL HANGERS



#### Round Magnetic Towel Hangers

Size	Colour	Code	£ Ex VAT	£ Inc VAT
600mm	Gloss White	101.0071	96.00	115.20
600mm	Chrome	101.0072	102.00	122.40



#### Square Magnetic Towel Hangers

Size	Colour	Code	£ Ex VAT	£ Inc VAT
600mm	Gloss White	101.0073	97.00	116.40
600mm	Chrome	101.0074	109.00	130.80

Both Round & Square towel hangers come in three unassembled pieces. Please cut 600mm bar to required column-to-column length. Holds up to 5kg weight.

# Designer Range

## ADDINGTON TYPE 20 - MATT ANTHRACITE



Pictured 91.0042 Matt Anthracite (Fitted Vertically)



Bar Dimensions (mm)

Vertical Bars 70 x 11mm

Pictured 91.0157 Matt Anthracite (Fitted Vertically) with 101.0074 Towel Hanger



HEATING NOTE:  
Radiators that are electric only are restricted to the heat output of the elements.

Warranty

**5**

Year

Heating

All Electric

Dual-Fuel

Pictured 91.0161 (Fitted Vertically)

# Designer Range

## ADDINGTON TYPE 20 - MATT ANTHRACITE

A designer radiator range available to fit both vertically and horizontally designs in a matt anthracite finish.

### FEATURES

- Tested to BS EN 442 standards
- Double profile construction
- Maximum corrosion resistance
- Cataphoretic painting technology
- Can be installed vertically or horizontally
- Can be single, dual fuel or all electric
- 5 Year Manufacturer's Warranty\*
- \* With conditions

**Technical Tables  
& Drawings**  
Page 354-355



### 600mm Height

#### Addington Type 20 Vertical / Horizontal Radiators - Matt Anthracite

Size H x W	Watts	BTU	Element Output	Element Type	Code	£ Ex VAT	£ Inc VAT
600 x 292mm	401	1369	150W	A, A+	91.0153	297.00	356.40
600 x 366mm	502	1712	300W	A, A+	91.0154	341.00	409.20
600 x 440mm	602	2054	300W	A, A+, C, H	91.0155	387.00	464.40
600 x 514mm	702	2396	300W	A, A+, C, H	91.0156	434.00	520.80
600 x 588mm	803	2738	450W	A, A+, C, H	91.0157	483.00	579.60
600 x 662mm	903	3081	450W	A, A+, C, H	91.0158	530.00	636.00
600 x 810mm	1104	3765	600W	A, A+, C, E, H	91.0159	622.00	746.40
600 x 1032mm	1405	4792	750W	A, A+, C, E, H	91.0160	766.00	919.20
600 x 1180mm	1605	5477	900W	A, A+, C, E, H	91.0161	858.00	1029.60
600 x 1254mm	1706	5819	1000W	A, A+, C, E, H	91.0162	905.00	1086.00

### 1800mm Height

#### Addington Type 20 Vertical / Horizontal Radiators - Matt Anthracite

Size H x W	Watts	BTU	Element Output	Element Type	Code	£ Ex VAT	£ Inc VAT
1800 x 366mm	1329	4535	300W	A, A+	91.0039	676.00	811.20
1800 x 440mm	1595	5442	450W	A, A+	91.0040	800.00	960.00
1800 x 514mm	1861	6350	600W	A+	91.0041	924.00	1108.80
1800 x 588mm	2127	7257	600W	A+	91.0042	1048.00	1257.60

### TECHNICAL INFORMATION

All measurements in Height by Width. Heat output based on  $\Delta T 60^{\circ}\text{C}$ . Radiators that are electric only are restricted to the heat output of the elements. Element size can be increased to full capacity of rail if using element type C, E or H. For element types see pages 288-300. For matching valves see pages 301-309. Comes with pre-fitted flow diverter (except 500 & 600mm heights). Flow diverter must remain in place when radiator installed on central heating system (only for vertical installations). For indirect heating systems only. In vertical installation, tappings are the width of the rail and approx. 64mm off the wall. In horizontal installation, tappings are approx. 50mm less than the width of the rail and approx. 64mm off the wall. Price includes radiator and wall fixing sets, valves extra.



Pictured 91.0042 (Fitted Horizontally)

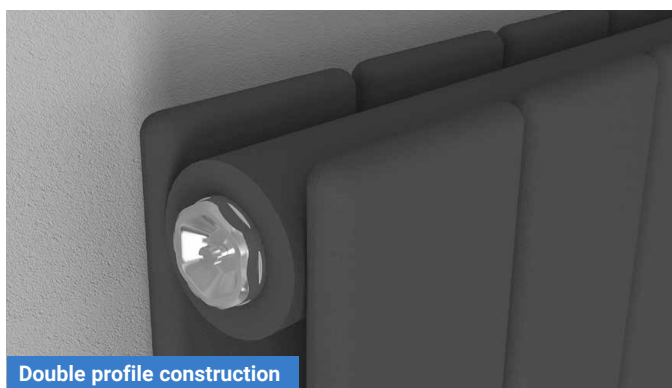

Double profile construction

Radiator can be installed vertically or horizontally using the pre-fitted wall bracket holders. (Below images)

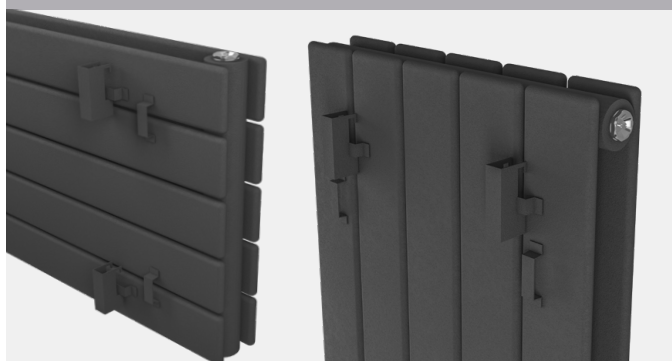

### Multi-Purpose Towel Hangers

Page 312



### Radiator Valves

Page 301-309



### Round Vent Caps

Page 313



### MAGNETIC TOWEL HANGERS



#### Round Magnetic Towel Hangers

Size	Colour	Code	£ Ex VAT	£ Inc VAT
600mm	Gloss White	101.0071	96.00	115.20
600mm	Chrome	101.0072	102.00	122.40



#### Square Magnetic Towel Hangers

Size	Colour	Code	£ Ex VAT	£ Inc VAT
600mm	Gloss White	101.0073	97.00	116.40
600mm	Chrome	101.0074	109.00	130.80

Both Round & Square towel hangers come in three unassembled pieces. Please cut 600mm bar to required column-to-column length. Holds up to 5kg weight.

# Designer Range

## ADDINGTON TYPE21 - HORIZONTAL

High Output 

Technical Tables  
& Drawings  
Page 356-357



Double profile construction  
with one row of convector fins



HEATING NOTE:  
Radiators that are  
electric only are  
restricted to the  
heat output of the  
elements.

Pictured 91.0044 Gloss White

Warranty  
**5**  
Year

Heating  

All Electric  

Dual-Fuel  

A horizontal only designer radiator range with high heat outputs in gloss white and matt anthracite finishes.

### Addington Type21 Horizontal Radiators - Gloss White

Size H x W	Watts	BTU	Element Output	Element Type	Code	£ Ex VAT	£ Inc VAT
588 x 600mm	994	3392	600W	A+	91.0043	570.00	<b>684.00</b>
588 x 800mm	1325	4521	600W	A, A+	91.0044	691.00	<b>829.20</b>
588 x 1000mm	1694	5780	600W	A, A+	91.0045	786.00	<b>943.20</b>
588 x 1200mm	1983	6766	600W	A, A+	91.0046	932.00	<b>1118.40</b>

### Addington Type21 Horizontal Radiators - Matt Anthracite

Size H x W	Watts	BTU	Element Output	Element Type	Code	£ Ex VAT	£ Inc VAT
588 x 600mm	994	3392	600W	A+	91.0047	570.00	<b>684.00</b>
588 x 800mm	1325	4521	600W	A, A+	91.0048	691.00	<b>829.20</b>
588 x 1000mm	1694	5780	600W	A, A+	91.0049	786.00	<b>943.20</b>
588 x 1200mm	1983	6766	600W	A, A+	91.0050	932.00	<b>1118.40</b>

#### FEATURES

- Tested to BS EN 442 standards
- Double profile construction with **one row of convector fins**
- Pre-fitted top grilles
- Maximum corrosion resistance
- Cataphoretic painting technology
- Can only be installed horizontally
- Can be single, dual fuel or all electric
- 5 Year Manufacturer's Warranty\*
- \* With conditions

#### TECHNICAL INFORMATION

All measurements in Height by Width. Heat output based on  $\Delta T60^{\circ}\text{C}$ . Radiators that are electric only are restricted to the heat output of the elements. For element types see pages 288-300. For matching valves see pages 301-309. For indirect heating systems only. Tappings are approx. 50mm less than the width of the rail and 75mm off the wall. Price includes radiator and wall fixing sets, valves extra.

#### Radiator Valves

Page 301-309



#### Round Vent Caps

Page 313



# Designer Range

## ADDINGTON TYPE22 - HORIZONTAL

High Output 

Technical Tables & Drawings  
Page 356-357



Double profile construction with two rows of convector fins



HEATING NOTE: Radiators that are electric only are restricted to the heat output of the elements.

Pictured 91.0060 Matt Anthracite

Warranty

5  
Year

Heating



All Electric



Dual-Fuel



### Addington Type22 Horizontal Radiators - Gloss White

Size H x W	Watts	BTU	Element Output	Element Type	Code	£ Ex VAT	£ Inc VAT
292 x 1200mm	1703	5811	N/A	N/A	91.0055	553.00	663.60
588 x 600mm	1252	4272	600W	A+	91.0051	607.00	728.40
588 x 800mm	1670	5698	600W	A, A+	91.0052	737.00	884.40
588 x 1000mm	2099	7162	600W	A, A+	91.0053	867.00	1040.40
588 x 1200mm	2519	8595	600W	A, A+	91.0054	994.00	1192.80

### Addington Type22 Horizontal Radiators - Matt Anthracite

Size H x W	Watts	BTU	Element Output	Element Type	Code	£ Ex VAT	£ Inc VAT
292 x 1200mm	1703	5811	N/A	N/A	91.0060	553.00	663.60
588 x 600mm	1252	4272	600W	A+	91.0056	607.00	728.40
588 x 800mm	1670	5698	600W	A, A+	91.0057	737.00	884.40
588 x 1000mm	2099	7162	600W	A, A+	91.0058	867.00	1040.40
588 x 1200mm	2519	8595	600W	A, A+	91.0059	994.00	1192.80

#### FEATURES

- Tested to BS EN 442 standards
- Double profile construction with **two rows of convector fins**
- Pre-fitted top grilles
- Maximum corrosion resistance
- Cataphoretic painting technology
- Can only be installed horizontally
- Can be single, dual fuel or all electric
- 5 Year Manufacturer's Warranty\*
- \* With conditions

#### TECHNICAL INFORMATION

All measurements in Height by Width. Heat output based on  $\Delta T60^{\circ}\text{C}$ . Radiators that are electric only are restricted to the heat output of the elements. For element types see pages 288-300. For matching valves see pages 301-309. For indirect heating systems only. Tappings are approx. 50mm less than the width of the rail and 85mm off the wall. Price includes radiator and wall fixing sets, valves extra.

#### Radiator Valves

Page 301-309



#### Round Vent Caps

Page 313



# Designer Range

## ADDINGTON TYPE 20 - TOWEL RAILS



Double profile construction



1110mm High



1750mm High

Warranty  
**5**  
Year

Heating

All Electric

Dual-Fuel

Technical Tables & Drawings  
Page 354-355

Pictured 91.0120 Gloss White

A designer towel rail with high heat output, available in 2 heights in gloss white and matt anthracite colours.

**FEATURES**

- Tested to BS EN 442 standards
- Double profile construction
- Maximum corrosion resistance
- Cataphoretic painting technology
- Can be single, dual fuel or all electric
- 5 Year Manufacturer's Warranty\*
- \* With conditions

**TECHNICAL INFORMATION**

All measurements in Height by Width. Heat output based on  $\Delta T60^{\circ}C$ . Radiators that are electric only are restricted to the heat output of the elements. Element size can be increased to full capacity of rail if using element type D, E, F or G. (Type F & G Elements suitable for all electric only) For element types see pages 288-300. For matching valves see pages 301-309. For indirect heating systems only. Tappings are 50mm less than the width of the rail and approx. 64mm off the wall. Price includes radiator and wall fixing sets, valves extra.

Addington Type 20 Towel Rails - Gloss White							
Size H x W	Watts	BTU	Element Output	Element Type	Code	£ Ex VAT	£ Inc VAT
1110 x 500mm	826	2817	450W	A, A+, D, E, F, G	91.0119	634.00	760.80
1750 x 500mm	1163	3966	600W	A, A+, D, E, F, G	91.0120	907.00	1088.40

Addington Type 20 Towel Rails - Matt Anthracite							
Size H x W	Watts	BTU	Element Output	Element Type	Code	£ Ex VAT	£ Inc VAT
1110 x 500mm	826	2817	450W	A, A+, D, E, F, G	91.0121	634.00	760.80
1750 x 500mm	1163	3966	600W	A, A+, D, E, F, G	91.0122	907.00	1088.40

**Radiator Valves**  
Page 301-309

**Round Vent Caps**  
Page 313

# Designer Range

## ADDINGTON TYPE 21 - TOWEL RAILS

Warranty

# 5

Year

Heating



All Electric



Dual-Fuel





Double profile construction with one row of convector fins



1110mm High



1750mm High



**Technical Tables & Drawings**  
Page 356-357



Pictured 91.0125 Matt Anthracite

A designer towel rail with high heat output, available in 2 heights in gloss white and matt anthracite colours.

### FEATURES

- Tested to BS EN 442 standards
  - Double profile construction with **one row of convector fins**
  - Maximum corrosion resistance
  - Cataphoretic painting technology
  - Can be single, dual fuel or all electric
  - 5 Year Manufacturer's Warranty\*
- \* With conditions

### TECHNICAL INFORMATION

All measurements in Height by Width. Heat output based on  $\Delta T60^{\circ}\text{C}$ . Radiators that are electric only are restricted to the heat output of the elements. Element size can be increased to full capacity of rail if using element type D, E, F or G. (Type F & G Elements suitable for all electric only) For element types see pages 288-300. For matching valves see pages 301-309. For indirect heating systems only. Tappings are 50mm less than the width of the rail and approx. 75mm off the wall. Price includes radiator and wall fixing sets, valves extra.

### Addington Type 21 Towel Rails - Gloss White

Size H x W	Watts	BTU	Element Output	Element Type	Code	£ Ex VAT	£ Inc VAT
1110 x 500mm	1060	3615	600W	A, A+, D, E, F, G	91.0123	746.00	895.20
1750 x 500mm	1455	4962	900W	A, A+, D, E, F, G	91.0124	1054.00	1264.80

### Addington Type 21 Towel Rails - Matt Anthracite

Size H x W	Watts	BTU	Element Output	Element Type	Code	£ Ex VAT	£ Inc VAT
1110 x 500mm	1060	3615	600W	A, A+, D, E, F, G	91.0125	746.00	895.20
1750 x 500mm	1455	4962	900W	A, A+, D, E, F, G	91.0126	1054.00	1264.80

### Radiator Valves

Page 301-309



### Round Vent Caps

Page 313







# Compact Panel Range

Introducing our latest range of Compact Panel radiators. Offering a selection of approximately 200 sizes, you can be confident in discovering the ideal solution for efficient home heating that perfectly matches your space.

## Contents

Type 11 Compact Panel Radiator	160
Type 21 Compact Panel Radiator	161
Type 22 Compact Panel Radiator	162
Type 11, 21 & 22 Compact Panel Radiator, Matt Anthracite	163
Type 11, 21 & 22 Compact Panel Radiator, Matt Black	164
Flat Cover Plates, Available in 3 colours	166
Flat Cover Plates with Lines, Available in 3 colours	167



# Type 11 - Gloss White



## COMPACT PANEL TYPE 11 - GLOSS WHITE

Height H mm	Width W mm	Heat Output ΔT50°C		Heat Output ΔT60°C		Water Content / Litres	Weight / Kg	Code	£ Ex VAT	£ Inc VAT
		Watts	BTU	Watts	BTU					
<b>300</b>	400	194	662	245	837	0.68	3.91	25.0010	73.65	<b>88.38</b>
	500	243	828	307	1047	0.85	4.64	25.0011	92.01	<b>110.41</b>
	600	291	993	368	1255	1.02	5.38	25.0012	110.43	<b>132.51</b>
	800	388	1324	490	1674	1.36	6.93	25.0013	128.84	<b>154.60</b>
	1000	485	1655	613	2092	1.70	8.41	25.0014	184.07	<b>220.88</b>
	1200	582	1986	736	2510	2.04	9.89	25.0015	220.88	<b>265.05</b>
	1400	679	2317	858	2929	2.38	11.44	25.0016	257.69	<b>309.22</b>
	1600	776	2648	981	3347	2.72	12.92	25.0017	294.49	<b>353.38</b>
2000	970	3310	1226	4184	3.40	16.05	25.0018	368.12	<b>441.74</b>	



<b>400</b>	400	255	871	322	1101	0.84	5.03	25.0019	94.99	<b>113.98</b>
	500	319	1089	403	1376	1.05	6.02	25.0020	118.74	<b>142.48</b>
	600	383	1307	484	1652	1.26	7.00	25.0021	142.47	<b>170.96</b>
	700	447	1525	565	1928	1.50	7.98	25.0022	166.23	<b>199.47</b>
	800	511	1743	646	2203	1.68	9.03	25.0023	189.95	<b>227.94</b>
	900	575	1960	727	2477	1.90	10.02	25.0024	213.71	<b>256.45</b>
	1000	638	2178	806	2753	2.10	11.00	25.0025	237.43	<b>284.91</b>
	1100	702	2396	887	3029	2.30	11.97	25.0026	261.17	<b>313.40</b>
	1200	766	2614	968	3304	2.52	12.95	25.0027	284.93	<b>341.91</b>
	1400	894	3050	1130	3855	2.94	15.00	25.0028	332.42	<b>398.90</b>
	1600	1021	3485	1291	4405	3.36	16.96	25.0029	379.90	<b>455.88</b>
	1800	1149	3921	1452	4956	3.80	18.43	25.0030	427.39	<b>512.86</b>
2000	1277	4357	1614	5507	4.20	21.11	25.0031	474.89	<b>569.86</b>	



<b>500</b>	400	314	1072	397	1355	1.04	6.18	25.0032	114.85	<b>137.82</b>
	500	393	1340	497	1694	1.30	7.41	25.0033	143.58	<b>172.29</b>
	600	471	1608	595	2033	1.56	8.64	25.0034	172.25	<b>206.70</b>
	700	550	1876	695	2371	1.80	9.87	25.0035	201.03	<b>241.23</b>
	800	628	2144	794	2710	2.08	11.17	25.0036	229.72	<b>275.66</b>
	900	707	2412	894	3049	2.30	12.40	25.0037	258.42	<b>310.10</b>
	1000	785	2680	992	3388	2.60	13.64	25.0038	287.15	<b>344.58</b>
	1100	864	2948	1092	3726	2.90	14.87	25.0039	315.85	<b>379.02</b>
	1200	942	3216	1191	4065	3.12	16.10	25.0040	344.57	<b>413.48</b>
	1300	1021	3484	1291	4404	3.40	17.40	25.0041	373.29	<b>447.94</b>
	1400	1100	3752	1390	4743	3.64	18.63	25.0042	402.00	<b>482.40</b>
	1500	1175	4009	1485	5067	3.90	19.87	25.0043	430.72	<b>516.86</b>
	1600	1257	4288	1589	5420	4.16	21.10	25.0044	459.43	<b>551.31</b>
	1800	1414	4824	1787	6098	4.70	23.83	25.0045	516.87	<b>620.24</b>
2000	1571	5360	1986	6775	5.20	26.29	25.0046	574.26	<b>689.11</b>	



<b>600</b>	400	370	1263	468	1596	1.24	7.34	25.0047	133.71	<b>160.45</b>
	500	463	1578	585	1995	1.55	8.82	25.0048	167.13	<b>200.55</b>
	600	555	1894	702	2394	1.86	10.30	25.0049	200.56	<b>240.67</b>
	700	648	2209	819	2792	2.20	11.79	25.0050	233.99	<b>280.78</b>
	800	740	2525	935	3192	2.48	13.34	25.0051	267.40	<b>320.88</b>
	900	833	2841	1053	3591	2.80	14.82	25.0052	300.85	<b>361.02</b>
	1000	925	3156	1169	3989	3.10	16.30	25.0053	334.26	<b>401.11</b>
	1100	1018	3472	1287	4389	3.40	17.78	25.0054	367.68	<b>441.21</b>
	1200	1110	3788	1403	4788	3.72	19.27	25.0055	401.11	<b>481.33</b>
	1300	1195	4078	1510	5155	4.00	20.82	25.0056	434.52	<b>521.42</b>
	1400	1295	4419	1637	5586	4.34	22.30	25.0057	467.96	<b>561.55</b>
	1500	1385	4726	1751	5974	4.70	23.78	25.0058	501.39	<b>601.66</b>
	1600	1480	5050	1871	6383	4.96	25.26	25.0059	534.79	<b>641.74</b>
	1800	1665	5682	2105	7182	5.60	28.55	25.0060	601.68	<b>722.01</b>
	2000	1850	6313	2338	7980	6.20	31.51	25.0061	668.52	<b>802.22</b>



Manufacturer's Warranty **10** Years

Central Heating System

**UK CA CE**

# Type 21 - Gloss White



## COMPACT PANEL TYPE 21 - GLOSS WHITE

Height H mm	Width W mm	Heat Output ΔT50°C		Heat Output ΔT60°C		Water Content / Litres	Weight / Kg	Code	£ Ex VAT	£ Inc VAT
		Watts	BTU	Watts	BTU					
400	400	381	1300	482	1643	1.68	7.84	25.0078	145.17	174.20
	500	476	1625	602	2054	2.10	9.51	25.0079	181.49	217.78
	600	571	1950	722	2465	2.52	11.19	25.0080	217.79	261.34
	700	667	2275	843	2876	2.90	12.86	25.0081	254.07	304.88
	800	762	2600	963	3286	3.36	14.61	25.0082	290.39	348.46
	900	857	2925	1083	3697	3.80	16.28	25.0083	326.69	392.02
	1000	952	3250	1203	4108	4.20	17.95	25.0084	362.97	435.56
	1100	1048	3575	1325	4519	4.60	19.61	25.0085	399.29	479.14
	1200	1143	3899	1445	4928	5.04	21.27	25.0086	435.57	522.68
	1400	1333	4549	1685	5750	5.88	24.72	25.0087	508.17	609.80
	1600	1524	5199	1926	6572	6.72	28.07	25.0088	580.76	696.91
	1800	1714	5849	2166	7393	7.60	30.19	25.0089	653.35	784.02
2000	1905	6499	2408	8215	8.40	34.99	25.0090	725.95	871.14	



Type 21 - Height 400mm

500	400	459	1566	580	1979	2.08	9.68	25.0091	173.43	208.11
	500	574	1958	726	2475	2.60	11.79	25.0092	216.84	260.20
	600	689	2350	871	2970	3.12	13.89	25.0093	260.19	312.22
	700	803	2741	1015	3465	3.60	15.99	25.0094	303.56	364.27
	800	918	3133	1160	3960	4.16	18.16	25.0095	346.93	416.31
	900	1033	3524	1306	4454	4.70	20.27	25.0096	390.30	468.36
	1000	1148	3916	1451	4950	5.20	22.37	25.0097	433.66	520.39
	1100	1262	4308	1595	5445	5.70	24.47	25.0098	477.00	572.40
	1200	1377	4699	1741	5940	6.24	26.58	25.0099	521.49	625.78
	1400	1607	5482	2031	6929	7.28	30.85	25.0100	607.10	728.52
	1600	1836	6266	2321	7920	8.32	35.06	25.0101	693.84	832.60
	1800	2066	7049	2611	8910	9.40	39.53	25.0102	780.58	936.69
2000	2295	7832	2901	9900	10.40	43.74	25.0103	867.30	1040.76	



Type 21 - Height 500mm

600	400	533	1820	674	2300	2.48	11.55	25.0104	199.24	239.08
	500	667	2275	843	2876	3.10	14.08	25.0105	249.05	298.86
	600	800	2730	1011	3451	3.72	16.61	25.0106	298.86	358.63
	700	933	3185	1179	4026	4.30	19.14	25.0107	348.66	418.39
	800	1067	3640	1349	4601	4.96	21.75	25.0108	398.45	478.14
	900	1200	4095	1517	5176	5.60	24.28	25.0109	448.29	537.94
	1000	1334	4550	1686	5751	6.20	26.81	25.0110	498.09	597.70
	1100	1467	5005	1854	6326	6.80	29.34	25.0111	547.90	657.48
	1200	1600	5460	2022	6901	7.44	31.87	25.0112	597.70	717.24
	1300	1731	5906	2188	7465	8.10	34.48	25.0113	647.51	777.01
	1400	1867	6370	2360	8052	8.68	37.01	25.0114	697.33	836.79
	1500	2000	6824	2528	8626	9.30	39.54	25.0115	747.11	896.53
	1600	2134	7280	2697	9202	9.92	42.07	25.0116	796.93	956.31
	1800	2400	8190	3034	10352	11.20	47.45	25.0117	896.54	1075.84
2000	2667	9100	3371	11502	12.40	52.52	25.0118	996.17	1195.40	



Type 21 - Height 600mm

### FEATURES - TYPE 11 & 21 RADIATORS

- Tested to BS EN 442 standards
  - Manufactured in automatic production lines
  - Hot water central heating systems only
  - Max operating pressure 4 bars
  - Complete with fitted top grill & side panels
  - Radiators have 4 x 1/2" connections
  - Powder coated in RAL 9016 Gloss White
  - Installation kit included in packaging
  - 10 Year Manufacturer's Warranty\*
- \* With conditions

### Flat Panel Covers

Page 166

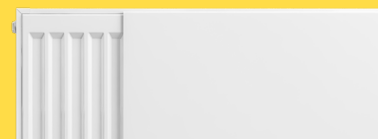

### Flat Panel Covers With Lines

Page 167

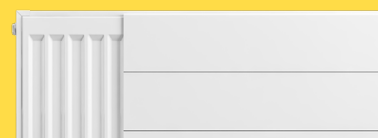

### TECHNICAL INFORMATION (TYPE 11 & 21)

All measurements in Height by Width. Heat outputs stated are based on ▲T50°C & ▲T60°C. Radiators are only suitable for two-pipe installations. Pipework installation is recommended after receipt of radiator. High quality mild steel material, 1.11mm thickness. Air vent and blanking plug included in installation kit. Tappings are the width of the radiator.

### Valves

Page 301-309



Manufacturer's Warranty **10** Years

Central Heating System



# Type 22 - Gloss White



## COMPACT PANEL TYPE 22 - GLOSS WHITE

Height H mm	Width W mm	Heat Output ΔT50°C		Heat Output ΔT60°C		Water Content / Litres	Weight / Kg	Code	£ Ex VAT	£ Inc VAT
		Watts	BTU	Watts	BTU					
<b>300</b>	400	368	1254	465	1585	1.36	6.68	25.0135	147.69	<b>177.22</b>
	600	551	1881	696	2378	2.04	9.41	25.0136	221.55	<b>265.86</b>
	800	735	2508	929	3170	2.72	12.21	25.0137	295.39	<b>354.46</b>
	1000	919	3135	1162	3963	3.40	14.93	25.0138	369.24	<b>443.08</b>
	1200	1103	3448	1394	4358	4.08	17.66	25.0139	443.08	<b>531.69</b>
	1400	1286	4389	1626	5548	4.76	20.46	25.0140	516.92	<b>620.30</b>
	1600	1470	5016	1858	6340	5.44	23.19	25.0141	590.77	<b>708.92</b>
2000	1838	6270	2323	7925	6.80	28.82	25.0142	738.50	<b>886.20</b>	



<b>400</b>	400	468	1596	592	2017	1.68	8.80	25.0143	187.60	<b>225.12</b>
	500	585	1996	739	2523	2.10	10.65	25.0144	234.49	<b>281.38</b>
	600	702	2395	887	3027	2.52	12.49	25.0145	281.41	<b>337.69</b>
	700	819	2794	1035	3532	2.90	14.34	25.0146	328.30	<b>393.96</b>
	800	936	3193	1183	4036	3.36	16.25	25.0147	375.20	<b>450.24</b>
	900	1053	3592	1331	4540	3.80	18.10	25.0148	422.11	<b>506.53</b>
	1000	1170	3991	1479	5045	4.20	19.94	25.0149	468.97	<b>562.76</b>
	1100	1287	4390	1627	5549	4.60	21.76	25.0150	515.91	<b>619.09</b>
	1200	1404	4789	1775	6053	5.04	23.60	25.0151	562.79	<b>675.34</b>
	1400	1638	5888	2070	7442	5.88	27.39	25.0152	656.57	<b>787.88</b>
	1600	1872	6386	2366	8072	6.72	31.08	25.0153	750.37	<b>900.44</b>
1800	2105	7184	2661	9081	7.60	33.53	25.0154	844.21	<b>1013.05</b>	
2000	2339	7982	2956	10089	8.40	38.67	25.0155	938.01	<b>1125.61</b>	



<b>500</b>	400	564	1925	713	2433	2.08	10.93	25.0156	224.40	<b>269.28</b>
	500	705	2406	891	3041	2.60	13.27	25.0157	280.52	<b>336.62</b>
	600	846	2887	1069	3649	3.12	15.60	25.0158	336.61	<b>403.93</b>
	700	987	3368	1248	4257	3.60	17.93	25.0159	392.72	<b>471.26</b>
	800	1128	3849	1426	4865	4.16	20.34	25.0160	448.84	<b>538.60</b>
	900	1269	4330	1604	5473	4.70	22.67	25.0161	504.91	<b>605.89</b>
	1000	1410	4812	1782	6082	5.20	25.01	25.0162	561.05	<b>673.26</b>
	1100	1551	5293	1960	6690	5.70	27.34	25.0163	617.14	<b>740.56</b>
	1200	1692	5774	2139	7298	6.24	29.67	25.0164	673.24	<b>807.88</b>
	1300	1833	6254	2317	7905	6.80	32.08	25.0165	729.33	<b>875.19</b>
	1400	1974	6736	2495	8514	7.28	34.41	25.0166	785.43	<b>942.51</b>
	1500	2112	7206	2670	9108	7.80	36.75	25.0167	841.55	<b>1009.86</b>
	1600	2256	7699	2852	9732	8.32	39.08	25.0168	897.62	<b>1077.14</b>
1800	2538	8661	3208	10948	9.40	44.02	25.0169	1009.83	<b>1211.79</b>	
2000	2820	9623	3564	12163	10.40	48.69	25.0170	1122.05	<b>1346.46</b>	



<b>600</b>	400	656	2240	829	2831	2.48	13.05	25.0171	258.28	<b>309.93</b>
	500	821	2800	1038	3539	3.10	15.89	25.0172	322.83	<b>387.39</b>
	600	985	3360	1245	4247	3.72	18.72	25.0173	387.44	<b>464.92</b>
	700	1149	3920	1452	4955	4.30	21.55	25.0174	451.97	<b>542.36</b>
	800	1313	4480	1660	5663	4.96	24.45	25.0175	516.56	<b>619.87</b>
	900	1477	5040	1867	6371	5.60	27.28	25.0176	581.12	<b>697.34</b>
	1000	1641	5600	2074	7078	6.20	30.10	25.0177	645.69	<b>774.82</b>
	1100	1805	6150	2282	7774	6.80	32.93	25.0178	710.27	<b>852.32</b>
	1200	1969	6720	2489	8494	7.44	35.76	25.0179	774.84	<b>929.80</b>
	1300	2130	7268	2692	9187	8.10	38.66	25.0180	818.74	<b>982.48</b>
	1400	2298	7840	2905	9910	8.68	41.49	25.0181	903.97	<b>1084.76</b>
	1500	2460	8394	3109	10610	9.30	44.31	25.0182	968.54	<b>1162.24</b>
	1600	2626	8960	3319	11325	9.92	47.14	25.0183	1033.13	<b>1239.75</b>
	1800	2954	10080	3734	12741	11.20	53.12	25.0184	1162.27	<b>1394.72</b>
2000	3282	10200	4148	12893	12.40	58.77	25.0185	1291.41	<b>1549.69</b>	



Manufacturer's Warranty **10** Years

Central Heating System

**UK CA CE**

# Type 11, 21 & 22 - Matt Anthracite

## COMPACT PANEL TYPE 11 - MATT ANTHRACITE

Height H mm	Width W mm	Heat Output ΔT50°C		Heat Output ΔT60°C		Water Content / Litres	Weight / Kg	Code	£ Ex VAT	£ Inc VAT
		Watts	BTU	Watts	BTU					
600	400	370	1263	468	1596	1.24	7.34	25.0062	147.08	<b>176.49</b>
	600	555	1894	702	2394	1.86	10.30	25.0063	220.62	<b>264.74</b>
	800	740	2525	935	3192	2.48	13.34	25.0064	294.14	<b>352.96</b>
	1000	925	3156	1169	3989	3.10	16.30	25.0065	367.69	<b>441.22</b>
	1200	1110	3788	1403	4788	3.72	19.27	25.0066	441.22	<b>529.46</b>
	1400	1295	4419	1637	5586	4.34	22.30	25.0067	514.75	<b>617.70</b>
	1600	1480	5050	1871	6383	4.96	25.26	25.0068	588.26	<b>705.91</b>
1800	1665	5682	2105	7182	5.60	28.55	25.0069	661.85	<b>794.22</b>	



Type 11 - Height 600mm

## COMPACT PANEL TYPE 21 - MATT ANTHRACITE

Height H mm	Width W mm	Heat Output ΔT50°C		Heat Output ΔT60°C		Water Content / Litres	Weight / Kg	Code	£ Ex VAT	£ Inc VAT
		Watts	BTU	Watts	BTU					
600	400	533	1820	674	2300	2.48	11.55	25.0119	219.16	<b>262.99</b>
	600	800	2730	1011	3451	3.72	16.61	25.0120	328.74	<b>394.48</b>
	800	1067	3640	1349	4601	4.96	21.75	25.0121	438.30	<b>525.96</b>
	1000	1334	4550	1686	5751	6.20	26.81	25.0122	547.89	<b>657.46</b>
	1200	1600	5460	2022	6901	7.44	31.87	25.0123	657.47	<b>788.96</b>
	1400	1867	6370	2360	8052	8.68	37.01	25.0124	767.07	<b>920.48</b>
	1600	2134	7280	2697	9202	9.92	42.07	25.0125	876.61	<b>1051.93</b>
1800	2400	8190	3034	10352	11.20	47.45	25.0126	986.19	<b>1183.42</b>	



Type 21 - Height 600mm

## COMPACT PANEL TYPE 22 - MATT ANTHRACITE

Height H mm	Width W mm	Heat Output ΔT50°C		Heat Output ΔT60°C		Water Content / Litres	Weight / Kg	Code	£ Ex VAT	£ Inc VAT
		Watts	BTU	Watts	BTU					
600	400	656	2240	829	2831	2.48	13.07	25.0186	284.10	<b>340.92</b>
	600	985	3360	1245	4247	3.72	18.72	25.0187	426.18	<b>511.41</b>
	800	1313	4480	1660	5663	4.96	24.45	25.0188	568.22	<b>681.86</b>
	1000	1641	5600	2074	7078	6.20	30.10	25.0189	710.26	<b>852.31</b>
	1200	1969	6720	2489	8494	7.44	35.76	25.0190	852.33	<b>1022.79</b>
	1400	2298	7840	2905	9910	8.68	41.49	25.0191	994.36	<b>1193.23</b>
	1600	2626	8960	3319	11325	9.92	47.14	25.0192	1136.44	<b>1363.72</b>
1800	2954	10080	3734	12741	11.20	53.12	25.0193	1278.49	<b>1534.18</b>	



Type 22 - Height 600mm

### FEATURES - TYPE 11, 21 & 22 RADIATORS

- Tested to BS EN 442 standards
- Manufactured in automatic production lines
- Hot water central heating systems only
- Max operating pressure 4 bars
- Complete with fitted top grill & side panels
- Radiators have 4 x 1/2" connections
- Installation kit included in packaging
- Powder coated in RAL 9016 Gloss White or Matt Anthracite special colour mixture (closest colour RAL 7016 Matt)
- 10 Year Manufacturer's Warranty\*
- \* With conditions

### Flat Panel Covers

Page 166



### Flat Panel Covers With Lines

Page 167

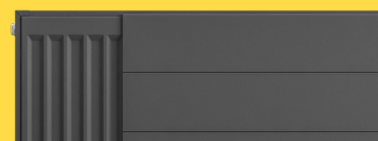

### TECHNICAL INFORMATION (TYPE 11, 21 & 22)

All measurements in Height by Width. Heat outputs stated are based on ΔT50°C & ΔT60°C. Radiators are only suitable for two-pipe installations. Pipework installation is recommended after receipt of radiator. High quality mild steel material, 1.11mm thickness. Air vent and blanking plug included in installation kit. Tappings are the width of the radiator.

### Valves

Page 301-309



# Type 11, 21 & 22 - Matt Black

## COMPACT PANEL TYPE 11 - MATT BLACK

Height H mm	Width W mm	Heat Output ΔT50°C		Heat Output ΔT60°C		Water Content / Litres	Weight / Kg	Code	£ Ex VAT	£ Inc VAT
		Watts	BTU	Watts	BTU					
600	400	370	1263	468	1596	1.24	7.34	25.0070	147.08	176.49
	600	555	1894	702	2394	1.86	10.30	25.0071	220.62	264.74
	800	740	2525	935	3192	2.48	13.34	25.0072	294.14	352.96
	1000	925	3156	1169	3989	3.10	16.30	25.0073	367.69	441.22
	1200	1110	3788	1403	4788	3.72	19.27	25.0074	441.22	529.46
	1400	1295	4419	1637	5586	4.34	22.30	25.0075	514.75	617.70
	1600	1480	5050	1871	6383	4.96	25.26	25.0076	588.26	705.91
1800	1665	5682	2105	7182	5.60	28.55	25.0077	661.85	794.22	



Type 11 - Height 600mm

## COMPACT PANEL TYPE 21 - MATT BLACK

Height H mm	Width W mm	Heat Output ΔT50°C		Heat Output ΔT60°C		Water Content / Litres	Weight / Kg	Code	£ Ex VAT	£ Inc VAT
		Watts	BTU	Watts	BTU					
600	400	533	1820	674	2300	2.48	11.55	25.0127	219.16	262.99
	600	800	2730	1011	3451	3.72	16.61	25.0128	328.74	394.48
	800	1067	3640	1349	4601	4.96	21.75	25.0129	438.30	525.96
	1000	1334	4550	1686	5751	6.20	26.81	25.0130	547.89	657.46
	1200	1600	5460	2022	6901	7.44	31.87	25.0131	657.47	788.96
	1400	1867	6370	2360	8052	8.68	37.01	25.0132	767.07	920.48
	1600	2134	7280	2697	9202	9.92	42.07	25.0133	876.61	1051.93
1800	2400	8190	3034	10352	11.20	47.45	25.0134	986.19	1183.42	



Type 21 - Height 600mm

## COMPACT PANEL TYPE 22 - MATT BLACK

Height H mm	Width W mm	Heat Output ΔT50°C		Heat Output ΔT60°C		Water Content / Litres	Weight / Kg	Code	£ Ex VAT	£ Inc VAT
		Watts	BTU	Watts	BTU					
600	400	656	2240	829	2831	2.48	13.07	25.0194	284.10	340.92
	600	985	3360	1245	4247	3.72	18.72	25.0195	426.18	511.41
	800	1313	4480	1660	5663	4.96	24.45	25.0196	568.22	681.86
	1000	1641	5600	2074	7078	6.20	30.10	25.0197	710.26	852.31
	1200	1969	6720	2489	8494	7.44	35.76	25.0198	852.33	1022.79
	1400	2298	7840	2905	9910	8.68	41.49	25.0199	994.36	1193.23
	1600	2626	8960	3319	11325	9.92	47.14	25.0200	1136.44	1363.72
1800	2954	10080	3734	12741	11.20	53.12	25.0201	1278.49	1534.18	



Type 22 - Height 600mm

### FEATURES - TYPE 11, 21 & 22 RADIATORS

- Tested to BS EN 442 standards
- Manufactured in automatic production lines
- Hot water central heating systems only
- Max operating pressure 4 bars
- Complete with fitted top grill & side panels
- Radiators have 4 x 1/2" connections
- Installation kit included in packaging
- Powder coated in RAL 9016 Gloss White or RAL 9005 Matt Black
- 10 Year Manufacturer's Warranty\*
- \* With conditions

### Flat Panel Covers

Page 166



### Flat Panel Covers With Lines

Page 167

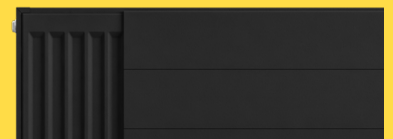

### TECHNICAL INFORMATION (TYPE 11, 21 & 22)

All measurements in Height by Width. Heat outputs stated are based on ΔT50°C & ΔT60°C. Radiators are only suitable for two-pipe installations. Pipework installation is recommended after receipt of radiator. High quality mild steel material, 1.11mm thickness. Air vent and blanking plug included in installation kit. Tappings are the width of the radiator.

### Valves

Page 301-309



# Technical Information

**Type 11 - Technical Drawing**

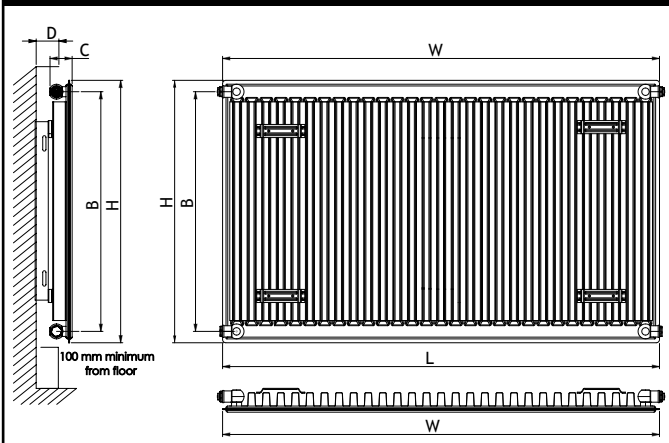

Height H (mm.)	Horizontal Tappings L (mm.)	Vertical Tappings B (mm.)	Radiator Depth C (mm.)	Tappings from Wall D (mm.)
300	W	245	50	38 / 50
400	W	345	50	38 / 50
500	W	445	50	38 / 50
600	W	545	50	38 / 50

\* Radiators have 4 tappings in total.

**Type 21 - Technical Drawing**

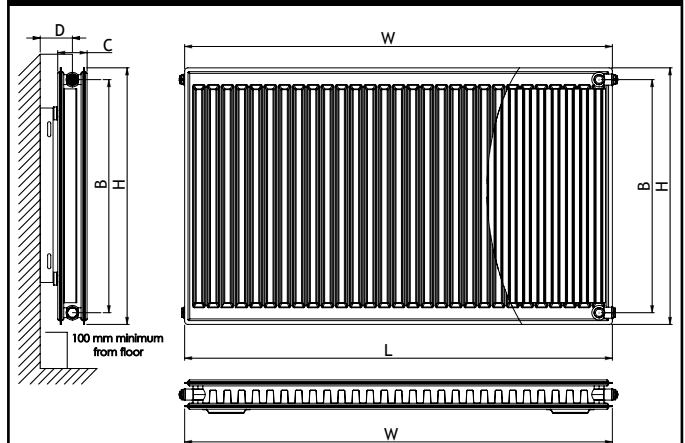

Height H (mm.)	Horizontal Tappings L (mm.)	Vertical Tappings B (mm.)	Radiator Depth C (mm.)	Tappings from Wall D (mm.)
400	W	345	70	56 / 68
500	W	445	70	56 / 68
600	W	545	70	56 / 68

\* Radiators have 4 tappings in total.

**Type 22 - Technical Drawing**

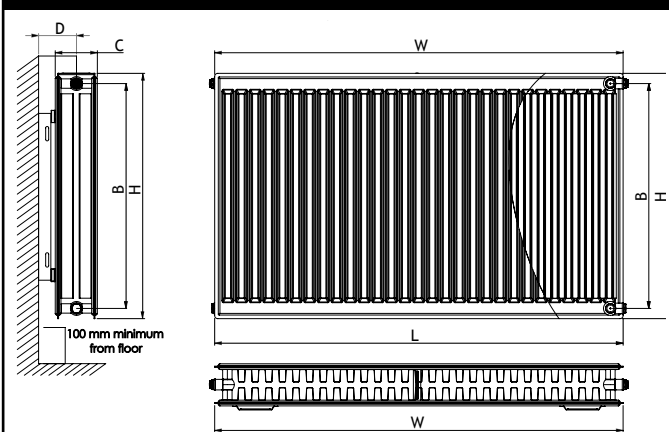

Height H (mm.)	Horizontal Tappings L (mm.)	Vertical Tappings B (mm.)	Radiator Depth C (mm.)	Tappings from Wall D (mm.)
300	W	245	102	72 / 84
400	W	345	102	72 / 84
500	W	445	102	72 / 84
600	W	545	102	72 / 84

\* Radiators have 4 tappings in total.

**Wall Brackets**

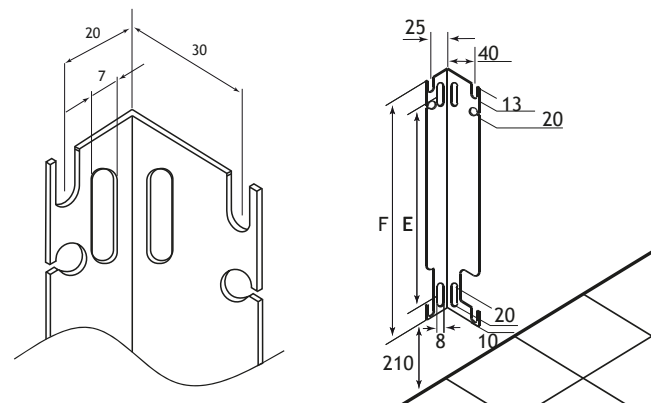

Radiator Height (mm.)	Bracket Length F (mm.)	Bracket Drilling Centre E (mm.)	Wall Bracket Code for 2 pcs	Wall Bracket Code for 3 pcs	Wall Bracket Quantity	
					2 pieces	3 pieces
300	108	-	25.9001	25.9005	Radiator Width 400 to 1600mm	Radiator Width 1800 to 2000mm
400	210	99	25.9002	25.9006		
500	309	198	25.9003	25.9007		
600	407	296	25.9004	25.9008		

\*All wall brackets for all colour radiators come in galvanised colour (nickel).

All radiators come with wall fixings and wall brackets. Wall Bracket codes are stated above for spare part requests.

**Bracket Positioning**

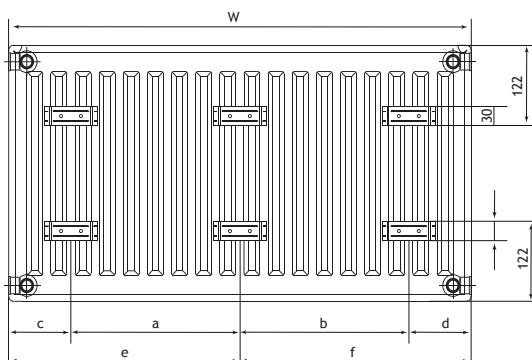

Radiator Width W (mm.)	Type 11 / Type 21 / Type 22							
	a (mm.)	b (mm.)	c (mm.)		d (mm.)		e (mm.)	f (mm.)
			Type 11	Type 21 / 22	Type 11	Type 21 / 22		
400 - 1600	W - 266.6	-	117	133.3	117	133.3	-	-
1800 - 2000	(W / 2) - 133.3	(W / 2) - 133.3	133.3		133.3		W / 2	W / 2

# Flat Cover Plates

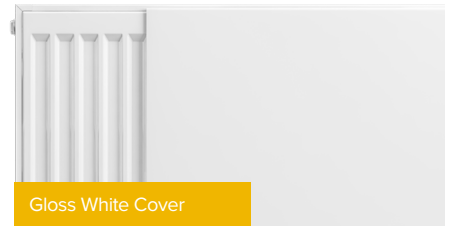

Gloss White Cover

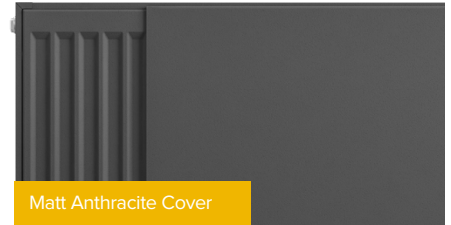

Matt Anthracite Cover

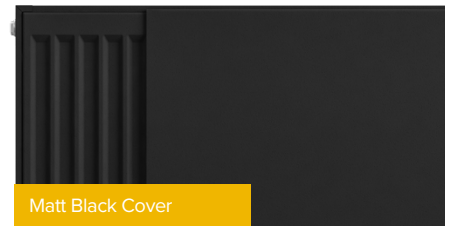

Matt Black Cover

## FLAT COVER PLATES - GLOSS WHITE

Height H	Width W	Code	£ Ex VAT	£ Inc VAT
mm	mm			
<b>300</b>	400	25.5000	252.00	<b>302.40</b>
	500	25.5001	265.00	<b>318.00</b>
	600	25.5002	279.00	<b>334.80</b>
	800	25.5003	305.00	<b>366.00</b>
	1000	25.5004	331.00	<b>397.20</b>
	1200	25.5005	357.00	<b>428.40</b>
	1400	25.5006	411.00	<b>493.20</b>
	1600	25.5007	437.00	<b>524.40</b>
2000	25.5008	490.00	<b>588.00</b>	

Height H	Width W	Code	£ Ex VAT	£ Inc VAT
mm	mm			
<b>400</b>	400	25.5009	264.00	<b>316.80</b>
	500	25.5010	281.00	<b>337.20</b>
	600	25.5011	297.00	<b>356.40</b>
	700	25.5012	312.00	<b>374.40</b>
	800	25.5013	329.00	<b>394.80</b>
	900	25.5014	345.00	<b>414.00</b>
	1000	25.5015	361.00	<b>433.20</b>
	1100	25.5016	377.00	<b>452.40</b>
	1200	25.5017	393.00	<b>471.60</b>
	1400	25.5018	453.00	<b>543.60</b>
1600	25.5019	486.00	<b>583.20</b>	
1800	25.5020	517.00	<b>620.40</b>	
2000	25.5021	550.00	<b>660.00</b>	

Height H	Width W	Code	£ Ex VAT	£ Inc VAT
mm	mm			
<b>500</b>	400	25.5022	277.00	<b>332.40</b>
	500	25.5023	296.00	<b>355.20</b>
	600	25.5024	315.00	<b>378.00</b>
	700	25.5025	334.00	<b>400.80</b>
	800	25.5026	353.00	<b>423.60</b>
	900	25.5027	372.00	<b>446.40</b>
	1000	25.5028	391.00	<b>469.20</b>
	1100	25.5029	410.00	<b>492.00</b>
	1200	25.5030	430.00	<b>516.00</b>
	1300	25.5031	476.00	<b>571.20</b>
	1400	25.5032	495.00	<b>594.00</b>
	1500	25.5033	514.00	<b>616.80</b>
	1600	25.5034	533.00	<b>639.60</b>
	1800	25.5035	572.00	<b>686.40</b>
2000	25.5036	609.00	<b>730.80</b>	

Height H	Width W	Code	£ Ex VAT	£ Inc VAT
mm	mm			
<b>600</b>	400	25.5037	288.00	<b>345.60</b>
	500	25.5038	310.00	<b>372.00</b>
	600	25.5039	332.00	<b>398.40</b>
	700	25.5040	353.00	<b>423.60</b>
	800	25.5041	375.00	<b>450.00</b>
	900	25.5042	397.00	<b>476.40</b>
	1000	25.5043	409.00	<b>490.80</b>
	1100	25.5044	440.00	<b>528.00</b>
	1200	25.5045	462.00	<b>554.40</b>
	1300	25.5046	512.00	<b>614.40</b>
	1400	25.5047	534.00	<b>640.80</b>
	1500	25.5048	555.00	<b>666.00</b>
	1600	25.5049	577.00	<b>692.40</b>
	1800	25.5050	620.00	<b>744.00</b>
	2000	25.5051	664.00	<b>796.80</b>

## FLAT COVER PLATES - MATT ANTHRACITE

Height H	Width W	Code	£ Ex VAT	£ Inc VAT
mm	mm			
<b>600</b>	400	25.5052	288.00	<b>345.60</b>
	600	25.5053	332.00	<b>398.40</b>
	800	25.5054	375.00	<b>450.00</b>
	1000	25.5055	409.00	<b>490.80</b>
	1200	25.5056	462.00	<b>554.40</b>
	1400	25.5057	534.00	<b>640.80</b>
	1600	25.5058	577.00	<b>692.40</b>
	1800	25.5059	620.00	<b>744.00</b>

## FLAT COVER PLATES - MATT BLACK

Height H	Width W	Code	£ Ex VAT	£ Inc VAT
mm	mm			
<b>600</b>	400	25.5060	288.00	<b>345.60</b>
	600	25.5061	332.00	<b>398.40</b>
	800	25.5062	375.00	<b>450.00</b>
	1000	25.5063	409.00	<b>490.80</b>
	1200	25.5064	462.00	<b>554.40</b>
	1400	25.5065	534.00	<b>640.80</b>
	1600	25.5066	577.00	<b>692.40</b>
	1800	25.5067	620.00	<b>744.00</b>

### FEATURES - FLAT COVER PLATES

- 1mm mild steel material
  - Both sides finished in high quality powder coating that matches radiator colour
  - Installation kit with clips & magnets included
  - Quick & Easy installation, please see QR video
  - Radiators sold separately
  - 10 Year Manufacturer's Warranty\*
- \* With conditions



Flat Cover Plate installation video

Quick & Easy!



# Flat Cover Plates with Lines

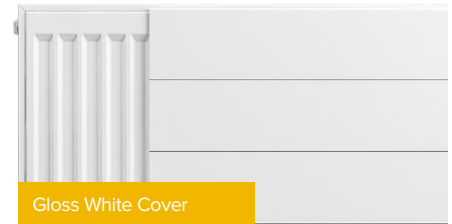

Gloss White Cover

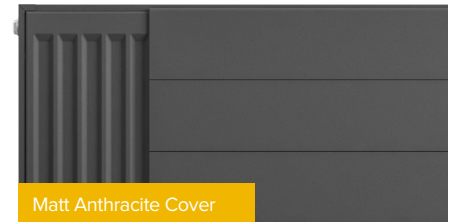

Matt Anthracite Cover

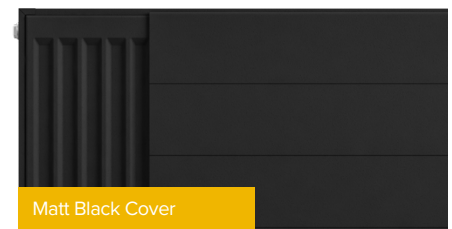

Matt Black Cover

## FLAT COVER PLATES WITH LINES - GLOSS WHITE

Height H	Width W	Code	£ Ex VAT	£ Inc VAT
mm	mm			
<b>300</b>	400	25.5068	258.00	<b>309.60</b>
	500	25.5069	270.00	<b>324.00</b>
	600	25.5070	284.00	<b>340.80</b>
	800	25.5071	310.00	<b>372.00</b>
	1000	25.5072	336.00	<b>403.20</b>
	1200	25.5073	363.00	<b>435.60</b>
	1400	25.5074	416.00	<b>499.20</b>
	1600	25.5075	443.00	<b>531.60</b>
2000	25.5076	495.00	<b>594.00</b>	

Height H	Width W	Code	£ Ex VAT	£ Inc VAT
mm	mm			
<b>400</b>	400	25.5077	269.00	<b>322.80</b>
	500	25.5078	286.00	<b>343.20</b>
	600	25.5079	302.00	<b>362.40</b>
	700	25.5080	318.00	<b>381.60</b>
	800	25.5081	334.00	<b>400.80</b>
	900	25.5082	350.00	<b>420.00</b>
	1000	25.5083	366.00	<b>439.20</b>
	1100	25.5084	383.00	<b>459.60</b>
	1200	25.5085	398.00	<b>477.60</b>
	1400	25.5086	458.00	<b>549.60</b>
	1600	25.5087	491.00	<b>589.20</b>
	2000	25.5089	555.00	<b>666.00</b>

Height H	Width W	Code	£ Ex VAT	£ Inc VAT
mm	mm			
<b>500</b>	400	25.5090	282.00	<b>338.40</b>
	500	25.5091	301.00	<b>361.20</b>
	600	25.5092	321.00	<b>385.20</b>
	700	25.5093	340.00	<b>408.00</b>
	800	25.5094	359.00	<b>430.80</b>
	900	25.5095	377.00	<b>452.40</b>
	1000	25.5096	396.00	<b>475.20</b>
	1100	25.5097	415.00	<b>498.00</b>
	1200	25.5098	435.00	<b>522.00</b>
	1300	25.5099	481.00	<b>577.20</b>
	1400	25.5100	500.00	<b>600.00</b>
	1500	25.5101	519.00	<b>622.80</b>
	1600	25.5102	538.00	<b>645.60</b>
	1800	25.5103	577.00	<b>692.40</b>
2000	25.5104	615.00	<b>738.00</b>	

Height H	Width W	Code	£ Ex VAT	£ Inc VAT
mm	mm			
<b>600</b>	400	25.5105	293.00	<b>351.60</b>
	500	25.5106	315.00	<b>378.00</b>
	600	25.5107	338.00	<b>405.60</b>
	700	25.5108	359.00	<b>430.80</b>
	800	25.5109	381.00	<b>457.20</b>
	900	25.5110	403.00	<b>483.60</b>
	1000	25.5111	414.00	<b>496.80</b>
	1100	25.5112	446.00	<b>535.20</b>
	1200	25.5113	468.00	<b>561.60</b>
	1300	25.5114	517.00	<b>620.40</b>
	1400	25.5115	539.00	<b>646.80</b>
	1500	25.5116	560.00	<b>672.00</b>
	1600	25.5117	582.00	<b>698.40</b>
	1800	25.5118	625.00	<b>750.00</b>
	2000	25.5119	669.00	<b>802.80</b>

## FLAT COVER PLATES WITH LINES - MATT ANTHRACITE

Height H	Width W	Code	£ Ex VAT	£ Inc VAT
mm	mm			
<b>600</b>	400	25.5120	293.00	<b>351.60</b>
	600	25.5121	338.00	<b>405.60</b>
	800	25.5122	381.00	<b>457.20</b>
	1000	25.5123	414.00	<b>496.80</b>
	1200	25.5124	468.00	<b>561.60</b>
	1400	25.5125	539.00	<b>646.80</b>
	1600	25.5126	582.00	<b>698.40</b>
	1800	25.5127	625.00	<b>750.00</b>

## FLAT COVER PLATES WITH LINES - MATT BLACK

Height H	Width W	Code	£ Ex VAT	£ Inc VAT
mm	mm			
<b>600</b>	400	25.5128	293.00	<b>351.60</b>
	600	25.5129	338.00	<b>405.60</b>
	800	25.5130	381.00	<b>457.20</b>
	1000	25.5131	414.00	<b>496.80</b>
	1200	25.5132	468.00	<b>561.60</b>
	1400	25.5133	539.00	<b>646.80</b>
	1600	25.5134	582.00	<b>698.40</b>
	1800	25.5135	625.00	<b>750.00</b>

### FEATURES - FLAT COVER PLATES WITH LINES

- 1mm mild steel material
  - Both sides finished in high quality powder coating that matches radiator colour
  - Installation kit with clips & magnets included
  - Quick & Easy installation, please see QR video
  - Radiators sold separately
  - 10 Year Manufacturer's Warranty\*
- \* With conditions



Flat Cover Plate installation video

Quick & Easy!

# Compact Panel Accessories

## Compact Panel Radiator Towel Hangers



Towel Hangers - Gloss White			
Description	Code	£ Ex VAT	£ Inc VAT
Towel Hanger 490mm. (for 600mm. width radiators)	25.5136	59.00	<b>70.80</b>
Towel Hanger 690mm. (for 800mm. width radiators)	25.5137	65.00	<b>78.00</b>
Towel Hanger 890mm. (for 1000mm width radiators)	25.5138	70.00	<b>84.00</b>
Fits on Compact Panel Radiators only			

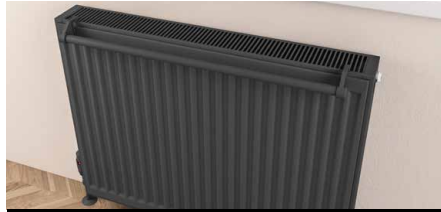

Towel Hangers - Anthracite			
Description	Code	£ Ex VAT	£ Inc VAT
Towel Hanger 490mm. (for 600mm. width radiators)	25.5139	59.00	<b>70.80</b>
Towel Hanger 690mm. (for 800mm. width radiators)	25.5140	65.00	<b>78.00</b>
Towel Hanger 890mm. (for 1000mm width radiators)	25.5141	70.00	<b>84.00</b>
Fits on Compact Panel Radiators only			



Towel Hangers - Black			
Description	Code	£ Ex VAT	£ Inc VAT
Towel Hanger 490mm. (for 600mm. width radiators)	25.5142	59.00	<b>70.80</b>
Towel Hanger 690mm. (for 800mm. width radiators)	25.5143	65.00	<b>78.00</b>
Towel Hanger 890mm. (for 1000mm width radiators)	25.5144	70.00	<b>84.00</b>
Fits on Compact Panel Radiators only			

## Pipe Shrouds and Collar Kits (Clip On)

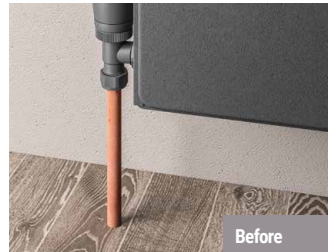

Pipe Shrouds and Collar Kits			
Description	Code	£ Ex VAT	£ Inc VAT
15mm Pipe Shroud & Collar Kit White	92.0001	14.00	<b>16.80</b>
15mm Pipe Shroud & Collar Kit Chrome	92.0002	21.00	<b>25.20</b>
15mm Pipe Shroud & Collar Kit Anthracite	92.0003	15.00	<b>18.00</b>
15mm Pipe Shroud & Collar Kit Black	92.0004	15.00	<b>18.00</b>

### FEATURES

- Manufactured from high grade polypropylene
- Suitable for 15mm pipes, easy-fit after radiator installation
- Available in white, anthracite, black and chrome
- Each kit includes two pipe shrouds and two collars
- Shroud length 200mm., can be cut to desired length
- Easy push-fit installation



## Pipe Shrouds and Collar Kits (Slide On)

**NEW**

Due in November 2023

Pipe Shrouds and Collar Kits - Slide On			
Description	Code	£ Ex VAT	£ Inc VAT
15mm Pipe Shroud & Collar Kit Gloss White	41.0597	23.00	<b>27.60</b>
15mm Pipe Shroud & Collar Kit Matt White	41.0598	23.00	<b>27.60</b>
15mm Pipe Shroud & Collar Kit Matt Grey	41.0599	23.00	<b>27.60</b>
15mm Pipe Shroud & Collar Kit Matt Cappuccino	41.0600	23.00	<b>27.60</b>
15mm Pipe Shroud & Collar Kit Matt Anthracite	41.0601	23.00	<b>27.60</b>
15mm Pipe Shroud & Collar Kit Matt Black	41.0602	23.00	<b>27.60</b>
15mm Pipe Shroud & Collar Kit Chrome	41.0603	21.00	<b>25.20</b>
15mm Pipe Shroud & Collar Kit Brushed Brass	41.0604	29.00	<b>34.80</b>
15mm Pipe Shroud & Collar Kit Satin Nickel	41.0605	29.00	<b>34.80</b>

### FEATURES

- Manufactured from high quality brass
- Suitable for 15mm pipes, must be fitted together with radiator installation
- Each kit includes two pipe shrouds and two collars
- Shroud length 200mm., can be cut to desired length



# Manufacturing & Packaging

The Eastbrook compact panel radiators range offers 3 types of radiators in over 140 sizes and 3 colours; gloss white, matt anthracite and matt black that are available from stock.

Eastbrook compact panel radiators are produced in fully automated state-of-the-art production lines and each radiator is first degreased then zinc phosphated before being dipped in a water based cataphoretic paint. The final coat is applied by automatic robots using epoxy polyester electrostatic powder coating.

**Our compact panel radiators are packed in heavy duty, protective packaging. Side cartons, bubble wrap, plastic corner protection and shrink wrap will protect these radiators to their destination.**



## 10 YEAR MANUFACTURER'S WARRANTY

Our compact panel radiators are individually tested and supplied complete with a 10 Year Manufacturer's Warranty against any manufacturing or material fault. All our compact panel radiators have a working pressure of 4 Bars.

## COMPLETE WITH FIXING KITS

Each compact panel radiator is supplied with complete concealed wall brackets including air vent and blanking plug.

## QUALITY

All our compact panel radiators are manufactured under ISO 9001:2015 and comply to UKCA & CE standards.

## AFTERSALES

In the event of any questions or concerns, we have a dedicated Technical and Aftersales team that will be able to assist with regarding the installation of the radiators.

## Important Installation Notes

- Compact panel radiators must be installed by a qualified engineer. Instruction manual is to be followed to avoid any issues during installation.
- Consider using an Eastbrook valve set to get the perfect colour match. Have your system vented properly. A general cause of corrosion and leak problems are due to trapped air in the system.
- Make sure that the drain points are at lowest in the system and your system is thoroughly flushed before commissioning.
- System must be clean of residues such as metal, flux etc, this can cause pin-holes. Do not over pump the system which will cause negative pressure aeration that can also cause corrosion.
- It is recommended that an appropriately approved corrosion inhibitor must be subsequently added to the system in order to protect the radiator and other parts of the system to promote extended operating lifespan. Please ensure that, when adding inhibitor, not to underdose or overdose and follow the inhibitor instructions. The Ph level of the system water should be between 6.5 and 7.5.
- If the system water is too acidic then the metals in the system would corrode. If the system water is too alkaline, then there is a higher risk of electrolysis.
- Our compact panel radiators come with an instruction manual. Please follow the basic guidance above and in the instructions to protect your 10 year manufacturer's warranty and trouble free operating lifespan of your radiator.

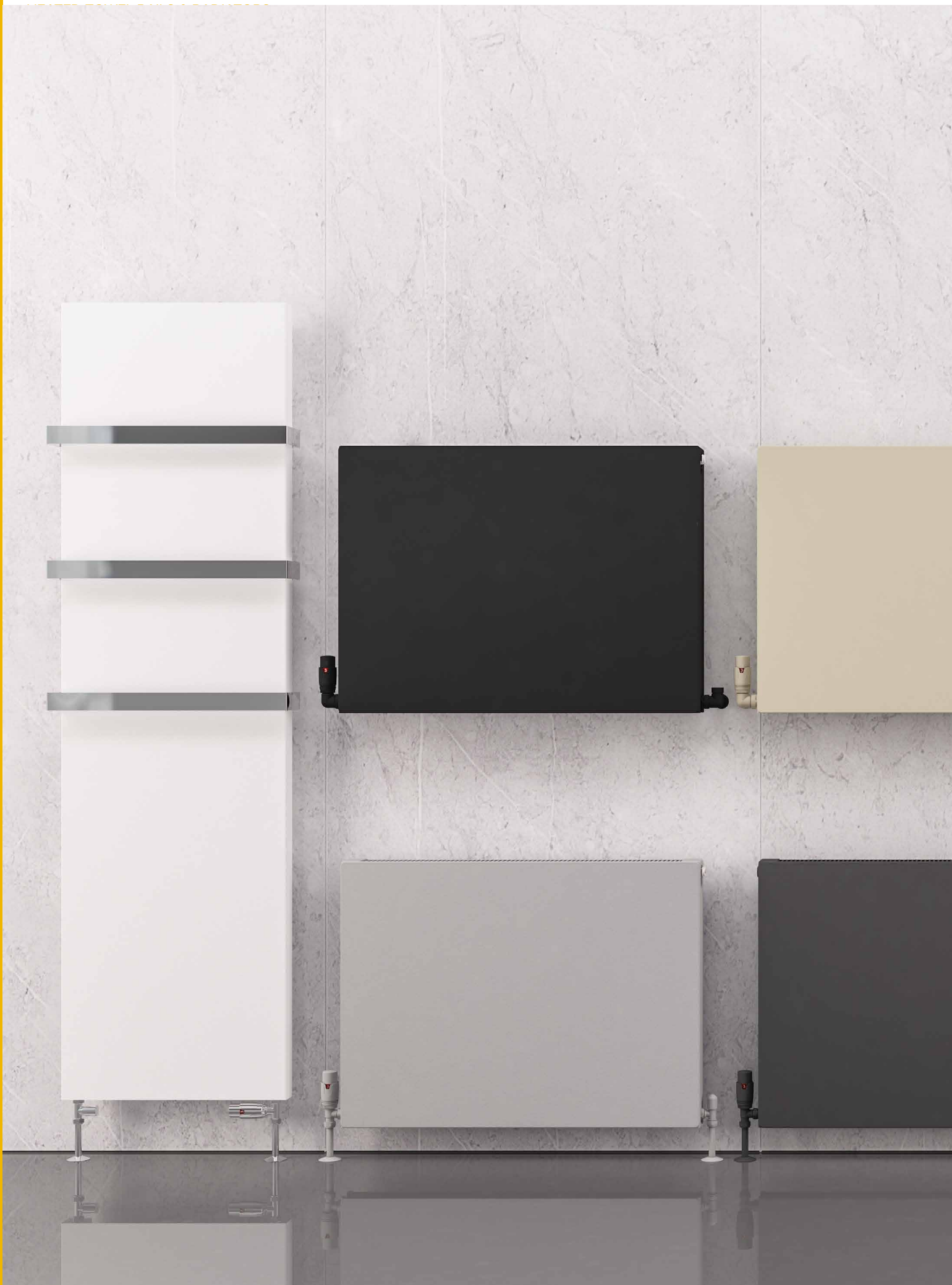

# Flat Panel Range

No more heavy and bulky panel radiators! A minimalist cover has been added to towel rail structured radiators and convector panels to produce a great heat output.

Stylish towel hanger accessories will allow you to use this radiator in your bathroom as well as other rooms.

## Contents

Wingrave Flat Panel Radiator Available in 3 colours	172-175
Type 11 Flat Panel Radiator Available in 6 colours	176-177
Type 22 Panel Radiator Available in 6 colours	178-179



# Flat Panel Range

## WINGRAVE FLAT PANEL RADIATORS



No more heavy & bulky panel radiators! A minimalist cover has been added to the Wingrave Towel Rail with built-in middle connection option. Also the stylish towel hangers will allow you to use this radiator in your bathroom as well as other rooms. Available in 2 heights and 3 colours.

### FEATURES

- Tested to BS EN 442 standards
- Wingrave towel rail with with flat panel cover
- Rear fixing metal wall brackets
- Comes with 50mm middle connection in addition to standard side connections
- Dual fuel connection without T piece, element fits in either left or right bottom side connection
- Blanking plug and air vent are at the rear of the radiator
- Can only be installed vertically
- Can be single or dual fuel, or all electric
- 5 Year Manufacturer's Warranty\*

\*With conditions

Technical Tables  
& Drawings  
Page 356-357



Warranty

5  
Year

Heating



All Electric



Dual-Fuel



# Flat Panel Range

## WINGRAVE FLAT PANEL RADIATORS

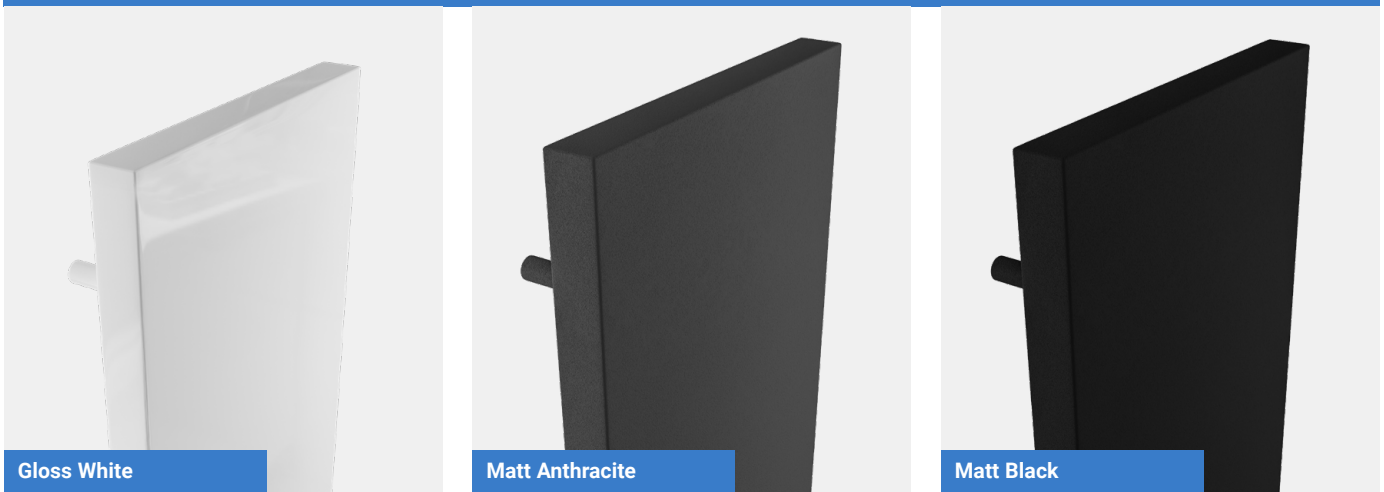

Gloss White

Matt Anthracite

Matt Black

### 1200mm Height

#### Wingrave Flat Panel Radiators - Gloss White

Size H x W	Watts	BTU	Element Output	Element Type	Code	£ Ex VAT	£ Inc VAT
1200 x 310mm	470	1604	150W	A, A+, D, E, F, G	89.1455	260.00	<b>312.00</b>
1200 x 410mm	593	2023	300W	A, A+, D, E, F, G	89.1456	273.00	<b>327.60</b>
1200 x 510mm	716	2443	300W	A, A+, D, E, F, G	89.1457	297.00	<b>356.40</b>
1200 x 610mm	840	2866	450W	A, A+, D, E, F, G	89.1458	321.00	<b>385.20</b>

#### Wingrave Flat Panel Radiators - Matt Anthracite

Size H x W	Watts	BTU	Element Output	Element Type	Code	£ Ex VAT	£ Inc VAT
1200 x 310mm	470	1604	150W	A, A+, D, E, F, G	89.1467	281.00	<b>337.20</b>
1200 x 410mm	593	2023	300W	A, A+, D, E, F, G	89.1468	296.00	<b>355.20</b>
1200 x 510mm	716	2443	300W	A, A+, D, E, F, G	89.1469	321.00	<b>385.20</b>
1200 x 610mm	840	2866	450W	A, A+, D, E, F, G	89.1470	345.00	<b>414.00</b>

#### Wingrave Flat Panel Radiators - Matt Black

Size H x W	Watts	BTU	Element Output	Element Type	Code	£ Ex VAT	£ Inc VAT
1200 x 310mm	470	1604	150W	A, A+, D, E, F, G	89.1479	281.00	<b>337.20</b>
1200 x 410mm	593	2023	300W	A, A+, D, E, F, G	89.1480	296.00	<b>355.20</b>
1200 x 510mm	716	2443	300W	A, A+, D, E, F, G	89.1481	321.00	<b>385.20</b>
1200 x 610mm	840	2866	450W	A, A+, D, E, F, G	89.1482	345.00	<b>414.00</b>

### 1200mm High Rear View Hidden air vent and blanking plug

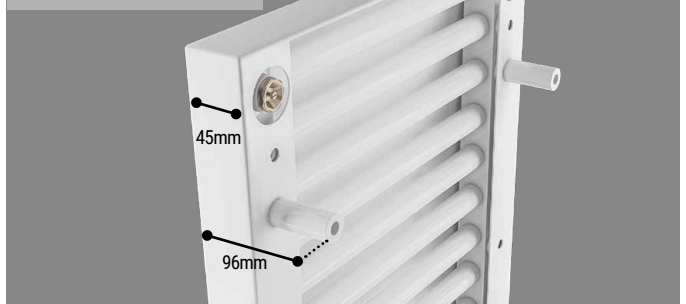

### TECHNICAL INFORMATION

All measurements in Height by Width. Heat output based on  $\Delta T60^{\circ}\text{C}$ . Radiators that are electric only are restricted to the heat output of the elements. Element size can be increased to full capacity of rail if using element type D, E, F or G. (Type F & G Elements suitable for all electric only) For element types see pages 288-300. For matching valves see pages 301-309. For indirect heating systems only. Middle connection is 50mm, and approx. 73mm off the wall. Side connections are 55mm less than the width of the rail and approx. 73mm off the wall. Price includes radiator and wall fixing sets, valves extra.

## WINGRAVE FLAT PANEL TOWEL HANGERS



### Towel Hanger - Gloss White

Size	Code	£ Ex VAT	£ Inc VAT
310mm	89.1459	50.00	<b>60.00</b>
410mm	89.1460	54.00	<b>64.80</b>
510mm	89.1461	61.00	<b>73.20</b>
610mm	89.1462	68.00	<b>81.60</b>



### Towel Hanger - Matt Anthracite

Size	Code	£ Ex VAT	£ Inc VAT
310mm	89.1471	50.00	<b>60.00</b>
410mm	89.1472	54.00	<b>64.80</b>
510mm	89.1473	61.00	<b>73.20</b>
610mm	89.1474	68.00	<b>81.60</b>



### Towel Hanger - Matt Black

Size	Code	£ Ex VAT	£ Inc VAT
310mm	89.1483	50.00	<b>60.00</b>
410mm	89.1484	54.00	<b>64.80</b>
510mm	89.1485	61.00	<b>73.20</b>
610mm	89.1486	68.00	<b>81.60</b>



### Towel Hanger - Chrome

Size	Code	£ Ex VAT	£ Inc VAT
310mm	89.1487	50.00	<b>60.00</b>
410mm	89.1488	54.00	<b>64.80</b>
510mm	89.1489	61.00	<b>73.20</b>
610mm	89.1490	68.00	<b>81.60</b>

### TECHNICAL INFORMATION

#### Vertical Radiators:

1200mm height radiators come with 2 towel hanger locations, with a maximum of 2 towel hangers - all widths; 310, 410, 510 and 610mm. Wingrave Flat Panel Towel Hangers are compatible with 1200mm height Wingrave Flat Panel Radiators.

**Must be fitted before installation.**

# Flat Panel Range

## WINGRAVE FLAT PANEL RADIATORS

1800mm High



Available for Dual Fuel Installation

Rear fixing metal wall brackets

Pictured 89.1453 Gloss White with 89.1489 Towel Hangers x3 and 54.0003 TRV Valve

1800mm High



Comes with 50mm middle connection in addition to standard side connections.

Pictured 89.1464 Matt Anthracite with 89.1472 Towel Hanger and 41.3021 TRV Valve

No more heavy & bulky panel radiators! A minimalist cover has been added to the Wingrave Towel Rail with built-in middle connection option. Also the stylish towel hangers will allow you to use this radiator in your bathroom as well as other rooms. Available in 2 heights and 3 colours.

### FEATURES

- Tested to BS EN 442 standards
- Wingrave towel rail with with flat panel cover
- Rear fixing metal wall brackets
- Comes with 50mm middle connection in addition to standard side connections
- Dual fuel connection without T piece, element fits in either left or right bottom side connection
- Blanking plug and air vent are at the rear of the radiator
- Can only be installed vertically
- Can be single or dual fuel, or all electric
- 5 Year Manufacturer's Warranty\*

\*With conditions

### Technical Tables & Drawings

Page 356-357



Warranty

5 Year

Heating



All Electric



Dual-Fuel





# Flat Panel Range

## WINGRAVE FLAT PANEL RADIATORS

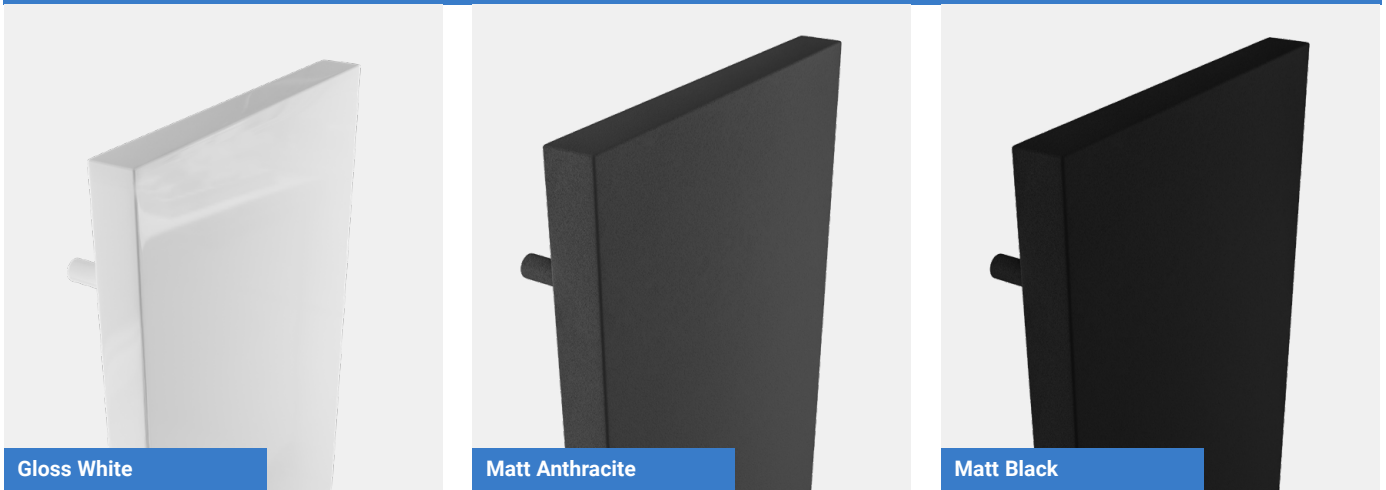

Gloss White

Matt Anthracite

Matt Black

### 1800mm Height

#### Wingrave Flat Panel Radiators - Gloss White

Size H x W	Watts	BTU	Element Output	Element Type	Code	£ Ex VAT	£ Inc VAT
1800 x 310mm	694	2368	300W	A, A+, D, E, F, G	89.1451	315.00	<b>378.00</b>
1800 x 410mm	874	2982	450W	A, A+, D, E, F, G	89.1452	340.00	<b>408.00</b>
1800 x 510mm	1054	3596	450W	A, A+, D, E, F, G	89.1453	380.00	<b>456.00</b>
1800 x 610mm	1234	4211	600W	A, A+, D, E, F, G	89.1454	420.00	<b>504.00</b>

#### Wingrave Flat Panel Radiators - Matt Anthracite

Size H x W	Watts	BTU	Element Output	Element Type	Code	£ Ex VAT	£ Inc VAT
1800 x 310mm	694	2368	300W	A, A+, D, E, F, G	89.1463	341.00	<b>409.20</b>
1800 x 410mm	874	2982	450W	A, A+, D, E, F, G	89.1464	368.00	<b>441.60</b>
1800 x 510mm	1054	3596	450W	A, A+, D, E, F, G	89.1465	410.00	<b>492.00</b>
1800 x 610mm	1234	4211	600W	A, A+, D, E, F, G	89.1466	454.00	<b>544.80</b>

#### Wingrave Flat Panel Radiators - Matt Black

Size H x W	Watts	BTU	Element Output	Element Type	Code	£ Ex VAT	£ Inc VAT
1800 x 310mm	694	2368	300W	A, A+, D, E, F, G	89.1475	341.00	<b>409.20</b>
1800 x 410mm	874	2982	450W	A, A+, D, E, F, G	89.1476	368.00	<b>441.60</b>
1800 x 510mm	1054	3596	450W	A, A+, D, E, F, G	89.1477	410.00	<b>492.00</b>
1800 x 610mm	1234	4211	600W	A, A+, D, E, F, G	89.1478	454.00	<b>544.80</b>

### 1800mm High Rear View Hidden air vent and blanking plug

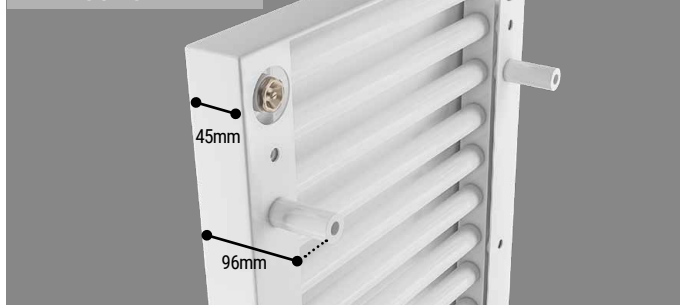

### TECHNICAL INFORMATION

All measurements in Height by Width. Heat output based on  $\Delta T60^{\circ}\text{C}$ . Radiators that are electric only are restricted to the heat output of the elements. Element size can be increased to full capacity of rail if using element type D, E, F or G. (Type F & G Elements suitable for all electric only) For element types see pages 288-300. For matching valves see pages 301-309. For indirect heating systems only. Middle connection is 50mm. and and approx. 73mm off the wall. Side connections are 55mm less than the width of the rail and approx. 73mm off the wall. Price includes radiator and wall fixing sets, valves extra.

## WINGRAVE FLAT PANEL TOWEL HANGERS



### Towel Hanger - Gloss White

Size	Code	£ Ex VAT	£ Inc VAT
310mm	89.1459	50.00	<b>60.00</b>
410mm	89.1460	54.00	<b>64.80</b>
510mm	89.1461	61.00	<b>73.20</b>
610mm	89.1462	68.00	<b>81.60</b>



### Towel Hanger - Matt Anthracite

Size	Code	£ Ex VAT	£ Inc VAT
310mm	89.1471	50.00	<b>60.00</b>
410mm	89.1472	54.00	<b>64.80</b>
510mm	89.1473	61.00	<b>73.20</b>
610mm	89.1474	68.00	<b>81.60</b>



### Towel Hanger - Matt Black

Size	Code	£ Ex VAT	£ Inc VAT
310mm	89.1483	50.00	<b>60.00</b>
410mm	89.1484	54.00	<b>64.80</b>
510mm	89.1485	61.00	<b>73.20</b>
610mm	89.1486	68.00	<b>81.60</b>



### Towel Hanger - Chrome

Size	Code	£ Ex VAT	£ Inc VAT
310mm	89.1487	50.00	<b>60.00</b>
410mm	89.1488	54.00	<b>64.80</b>
510mm	89.1489	61.00	<b>73.20</b>
610mm	89.1490	68.00	<b>81.60</b>

### TECHNICAL INFORMATION

#### Vertical Radiators:

1800mm height radiators come with 3 towel hanger locations, with a maximum of 3 towel hangers - all widths; 310, 410, 510 and 610mm. Wingrave Flat Panel Towel Hangers are compatible with 1800mm height Wingrave Flat Panel Radiators.

**Must be fitted before installation.**

# Flat Panel Range

## TYPE 11 FLAT PANEL RADIATORS



Pictured 44.0018 Gloss White

Combining single convector panel radiators, finished with smooth front & side panels and a top grille.

### FEATURES

- Tested to BS EN 442 standards
- Single Flat Panel with one row of convector fins
- Pre-fitted top grilles and side cover panels
- Available in 3 heights and up to 8 widths
- Gloss White and 5 more colours in stock
- Can only be installed horizontally
- Not suitable for elements
- 5 Year Manufacturer's Warranty\*

\*With conditions

Technical Tables  
& Drawings  
Page 358-359



Warranty

5  
Year

Heating

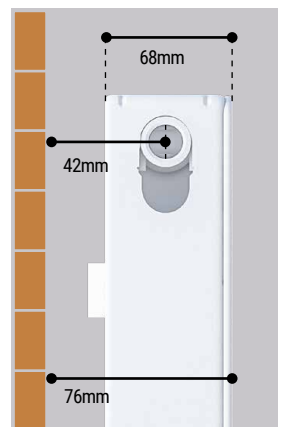

### TECHNICAL INFORMATION

All measurements in Height by Width. Heat output based on  $\Delta T60^{\circ}\text{C}$ . For matching valves see pages 301-309. For indirect heating systems only. Tappings are the width of the rail and approx. 42mm off the wall. Price includes radiator and wall fixing sets, valves extra.

400mm Height		WHILE STOCKS LAST!				
Type 11 Flat Panel Radiators - Gloss White						
Size H x W	Watts	BTU	Code	£ Ex VAT	£ Inc VAT	
400 x 600mm	439	1497	44.0001	144.00	<b>172.80</b>	
400 x 800mm	586	1998	44.0002	170.00	<b>204.00</b>	
400 x 1000mm	733	2500	44.0003	194.00	<b>232.80</b>	
400 x 1200mm	881	3005	44.0004	225.00	<b>270.00</b>	
400 x 1400mm	1027	3502	44.0005	250.00	<b>300.00</b>	
400 x 1600mm	1175	4007	44.0006	281.00	<b>337.20</b>	

500mm Height		WHILE STOCKS LAST!				
Type 11 Flat Panel Radiators - Gloss White						
Size H x W	Watts	BTU	Code	£ Ex VAT	£ Inc VAT	
500 x 400mm	360	1225	44.0007	125.00	<b>150.00</b>	
500 x 600mm	541	1844	44.0008	156.00	<b>187.20</b>	
500 x 800mm	722	2460	44.0009	187.00	<b>224.40</b>	
500 x 1000mm	903	3080	44.0010	217.00	<b>260.40</b>	
500 x 1200mm	1085	3699	44.0011	249.00	<b>298.80</b>	
500 x 1400mm	1266	4315	44.0012	282.00	<b>338.40</b>	
500 x 1600mm	1447	4934	44.0013	315.00	<b>378.00</b>	

600mm Height		WHILE STOCKS LAST!				
Type 11 Flat Panel Radiators - Gloss White						
Size H x W	Watts	BTU	Code	£ Ex VAT	£ Inc VAT	
600 x 400mm	424	1443	44.0014	139.00	<b>166.80</b>	
600 x 600mm	638	2174	44.0015	177.00	<b>212.40</b>	
600 x 800mm	851	2901	44.0016	212.00	<b>254.40</b>	
600 x 1000mm	1064	3628	44.0017	248.00	<b>297.60</b>	
600 x 1200mm	1277	4354	44.0018	286.00	<b>343.20</b>	
600 x 1400mm	1490	5081	44.0019	323.00	<b>387.60</b>	
600 x 1600mm	1705	5812	44.0020	364.00	<b>436.80</b>	
600 x 1800mm	1918	6538	44.0021	397.00	<b>476.40</b>	

# Flat Panel Range

## TYPE 11 FLAT PANEL RADIATORS

### COMPLETE THE LOOK

Pictured below:  
Angled Thermostatic Valves

Page: 308-309



**600mm Height** **WHILE STOCKS LAST!**

**Type 11 Flat Panel Radiators - Matt White**

Size H x W	Watts	BTU	Code	£ Ex VAT	£ Inc VAT
600 x 400mm	424	1443	44.0022	154.00	<b>184.80</b>
600 x 600mm	638	2174	44.0023	192.00	<b>230.40</b>
600 x 800mm	851	2901	44.0024	231.00	<b>277.20</b>
600 x 1000mm	1064	3628	44.0025	272.00	<b>326.40</b>
600 x 1200mm	1277	4354	44.0026	311.00	<b>373.20</b>
600 x 1400mm	1490	5081	44.0027	355.00	<b>426.00</b>
600 x 1600mm	1705	5812	44.0028	398.00	<b>477.60</b>



**600mm Height** **WHILE STOCKS LAST!**

**Type 11 Flat Panel Radiators - Matt Grey**

Size H x W	Watts	BTU	Code	£ Ex VAT	£ Inc VAT
600 x 400mm	424	1443	44.0029	154.00	<b>184.80</b>
600 x 600mm	638	2174	44.0030	192.00	<b>230.40</b>
600 x 800mm	851	2901	44.0031	231.00	<b>277.20</b>
600 x 1000mm	1064	3628	44.0032	272.00	<b>326.40</b>
600 x 1200mm	1277	4354	44.0033	311.00	<b>373.20</b>
600 x 1400mm	1490	5081	44.0034	355.00	<b>426.00</b>
600 x 1600mm	1705	5812	44.0035	398.00	<b>477.60</b>



**600mm Height** **WHILE STOCKS LAST!**

**Type 11 Flat Panel Radiators - Matt Cappuccino**

Size H x W	Watts	BTU	Code	£ Ex VAT	£ Inc VAT
600 x 400mm	424	1443	44.0036	154.00	<b>184.80</b>
600 x 600mm	638	2174	44.0037	192.00	<b>230.40</b>
600 x 800mm	851	2901	44.0038	231.00	<b>277.20</b>
600 x 1000mm	1064	3628	44.0039	272.00	<b>326.40</b>
600 x 1200mm	1277	4354	44.0040	311.00	<b>373.20</b>
600 x 1400mm	1490	5081	44.0041	355.00	<b>426.00</b>
600 x 1600mm	1705	5812	44.0042	398.00	<b>477.60</b>



**600mm Height** **WHILE STOCKS LAST!**

**Type 11 Flat Panel Radiators - Matt Anthracite**

Size H x W	Watts	BTU	Code	£ Ex VAT	£ Inc VAT
600 x 400mm	424	1443	44.0043	154.00	<b>184.80</b>
600 x 600mm	638	2174	44.0044	192.00	<b>230.40</b>
600 x 800mm	851	2901	44.0045	231.00	<b>277.20</b>
600 x 1000mm	1064	3628	44.0046	272.00	<b>326.40</b>
600 x 1200mm	1277	4354	44.0047	311.00	<b>373.20</b>
600 x 1400mm	1490	5081	44.0048	355.00	<b>426.00</b>
600 x 1600mm	1705	5812	44.0049	398.00	<b>477.60</b>

## MAGNETIC TOWEL HANGERS



**Round Magnetic Towel Hangers**

Size	Colour	Code	£ Ex VAT	£ Inc VAT
600mm	Gloss White	101.0071	96.00	<b>115.20</b>
600mm	Chrome	101.0072	102.00	<b>122.40</b>



Both Round & Square towel hangers come in three unassembled pieces. Please cut 600mm bar to required column-to-column length. Holds up to 5kg weight.

**Square Magnetic Towel Hangers**

Size	Colour	Code	£ Ex VAT	£ Inc VAT
600mm	Gloss White	101.0073	97.00	<b>116.40</b>
600mm	Chrome	101.0074	109.00	<b>130.80</b>



**600mm Height** **WHILE STOCKS LAST!**

**Type 11 Flat Panel Radiators - Matt Black**

Size H x W	Watts	BTU	Code	£ Ex VAT	£ Inc VAT
600 x 400mm	424	1443	44.0050	154.00	<b>184.80</b>
600 x 600mm	638	2174	44.0051	192.00	<b>230.40</b>
600 x 800mm	851	2901	44.0052	231.00	<b>277.20</b>
600 x 1000mm	1064	3628	44.0053	272.00	<b>326.40</b>
600 x 1200mm	1277	4354	44.0054	311.00	<b>373.20</b>
600 x 1400mm	1490	5081	44.0055	355.00	<b>426.00</b>
600 x 1600mm	1705	5812	44.0056	398.00	<b>477.60</b>

# Flat Panel Range

## TYPE 22 FLAT PANEL RADIATORS



Pictured 44.0073 Gloss White

Combining double convector panel radiators, finished with smooth front & side panels and a top grille.

### FEATURES

- Tested to BS EN 442 standards
- Double Flat Panels with two rows of convector fins
- Pre-fitted top grilles and side cover panels
- Available in 3 heights and up to 8 widths
- Gloss White and 5 more colours in stock
- Can only be installed horizontally
- Not suitable for elements
- 5 Year Manufacturer's Warranty\*

\*With conditions

**Technical Tables & Drawings**  
Page 358-359



Warranty

**5**  
Year

Heating

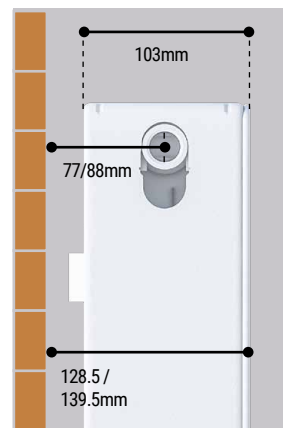

### TECHNICAL INFORMATION

All measurements in Height by Width. Heat output based on  $\Delta T60^{\circ}\text{C}$ . For matching valves see pages 301-309. For indirect heating systems only. Tappings are the width of the rail and approx. 77/88mm off the wall. Price includes radiator and wall fixing sets, valves extra.

400mm Height		WHILE STOCKS LAST!				
Type 22 Flat Panel Radiators - Gloss White						
Size H x W	Watts	BTU	Code	£ Ex VAT	£ Inc VAT	
400 x 600mm	815	2779	44.0057	200.00	<b>240.00</b>	
400 x 800mm	1085	3699	44.0058	248.00	<b>297.60</b>	
400 x 1000mm	1354	4616	44.0059	294.00	<b>352.80</b>	
400 x 1200mm	1624	5536	44.0060	344.00	<b>412.80</b>	
400 x 1400mm	1894	6456	44.0061	393.00	<b>471.60</b>	
400 x 1600mm	2161	7369	44.0062	443.00	<b>531.60</b>	

500mm Height		WHILE STOCKS LAST!				
Type 22 Flat Panel Radiators - Gloss White						
Size H x W	Watts	BTU	Code	£ Ex VAT	£ Inc VAT	
500 x 400mm	647	2206	44.0063	171.00	<b>205.20</b>	
500 x 600mm	973	3316	44.0064	226.00	<b>271.20</b>	
500 x 800mm	1297	4422	44.0065	284.00	<b>340.80</b>	
500 x 1000mm	1623	5532	44.0066	339.00	<b>406.80</b>	
500 x 1200mm	1947	6639	44.0067	393.00	<b>471.60</b>	
500 x 1400mm	2272	7745	44.0068	453.00	<b>543.60</b>	
500 x 1600mm	2597	8855	44.0069	509.00	<b>610.80</b>	

600mm Height		WHILE STOCKS LAST!				
Type 22 Flat Panel Radiators - Gloss White						
Size H x W	Watts	BTU	Code	£ Ex VAT	£ Inc VAT	
600 x 400mm	765	2607	44.0070	195.00	<b>234.00</b>	
600 x 600mm	1147	3910	44.0071	263.00	<b>234.00</b>	
600 x 800mm	1529	5214	44.0072	331.00	<b>397.20</b>	
600 x 1000mm	1911	6517	44.0073	395.00	<b>474.00</b>	
600 x 1200mm	2294	7820	44.0074	466.00	<b>559.20</b>	
600 x 1400mm	2676	9124	44.0075	532.00	<b>638.40</b>	
600 x 1600mm	3058	10427	44.0076	603.00	<b>723.60</b>	
600 x 1800mm	3440	11730	44.0077	666.00	<b>799.20</b>	

# Flat Panel Range

## TYPE 22 FLAT PANEL RADIATORS

### COMPLETE THE LOOK

Pictured below:  
Angled Thermostatic Valves

Page: 3 08-309



600mm Height **WHILE STOCKS LAST!**

#### Type 22 Flat Panel Radiators - Matt White

Size H x W	Watts	BTU	Code	£ Ex VAT	£ Inc VAT
600 x 400mm	765	2607	44.0078	217.00	<b>260.40</b>
600 x 600mm	1147	3910	44.0079	288.00	<b>345.60</b>
600 x 800mm	1529	5214	44.0080	364.00	<b>436.80</b>
600 x 1000mm	1911	6517	44.0081	435.00	<b>522.00</b>
600 x 1200mm	2294	7820	44.0082	511.00	<b>613.20</b>
600 x 1400mm	2676	9124	44.0083	587.00	<b>704.40</b>
600 x 1600mm	3058	10427	44.0084	662.00	<b>794.40</b>



600mm Height **WHILE STOCKS LAST!**

#### Type 22 Flat Panel Radiators - Matt Grey

Size H x W	Watts	BTU	Code	£ Ex VAT	£ Inc VAT
600 x 400mm	765	2607	44.0085	217.00	<b>260.40</b>
600 x 600mm	1147	3910	44.0086	288.00	<b>345.60</b>
600 x 800mm	1529	5214	44.0087	364.00	<b>436.80</b>
600 x 1000mm	1911	6517	44.0088	435.00	<b>522.00</b>
600 x 1200mm	2294	7820	44.0089	511.00	<b>613.20</b>
600 x 1400mm	2676	9124	44.0090	587.00	<b>704.40</b>
600 x 1600mm	3058	10427	44.0091	662.00	<b>794.40</b>



600mm Height **WHILE STOCKS LAST!**

#### Type 22 Flat Panel Radiators - Matt Cappuccino

Size H x W	Watts	BTU	Code	£ Ex VAT	£ Inc VAT
600 x 400mm	765	2607	44.0092	217.00	<b>260.40</b>
600 x 600mm	1147	3910	44.0093	288.00	<b>345.60</b>
600 x 800mm	1529	5214	44.0094	364.00	<b>436.80</b>
600 x 1000mm	1911	6517	44.0095	435.00	<b>522.00</b>
600 x 1200mm	2294	7820	44.0096	511.00	<b>613.20</b>
600 x 1400mm	2676	9124	44.0097	587.00	<b>704.40</b>
600 x 1600mm	3058	10427	44.0098	662.00	<b>794.40</b>



600mm Height **WHILE STOCKS LAST!**

#### Type 22 Flat Panel Radiators - Matt Anthracite

Size H x W	Watts	BTU	Code	£ Ex VAT	£ Inc VAT
600 x 400mm	765	2607	44.0099	217.00	<b>260.40</b>
600 x 600mm	1147	3910	44.0100	288.00	<b>345.60</b>
600 x 800mm	1529	5214	44.0101	364.00	<b>436.80</b>
600 x 1000mm	1911	6517	44.0102	435.00	<b>522.00</b>
600 x 1200mm	2294	7820	44.0103	511.00	<b>613.20</b>
600 x 1400mm	2676	9124	44.0104	587.00	<b>704.40</b>
600 x 1600mm	3058	10427	44.0105	662.00	<b>794.40</b>

## MAGNETIC TOWEL HANGERS



Round Magnetic Towel Hangers				
Size	Colour	Code	£ Ex VAT	£ Inc VAT
600mm	Gloss White	101.0071	96.00	<b>115.20</b>
600mm	Chrome	101.0072	102.00	<b>122.40</b>



Both Round & Square towel hangers come in three unassembled pieces. Please cut 600mm bar to required column-to-column length. Holds up to 5kg weight.

Square Magnetic Towel Hangers				
Size	Colour	Code	£ Ex VAT	£ Inc VAT
600mm	Gloss White	101.0073	97.00	<b>116.40</b>
600mm	Chrome	101.0074	109.00	<b>130.80</b>



600mm Height **WHILE STOCKS LAST!**

#### Type 22 Flat Panel Radiators - Matt Black

Size H x W	Watts	BTU	Code	£ Ex VAT	£ Inc VAT
600 x 400mm	765	2607	44.0106	217.00	<b>260.40</b>
600 x 600mm	1147	3910	44.0107	288.00	<b>345.60</b>
600 x 800mm	1529	5214	44.0108	364.00	<b>436.80</b>
600 x 1000mm	1911	6517	44.0109	435.00	<b>522.00</b>
600 x 1200mm	2294	7820	44.0110	511.00	<b>613.20</b>
600 x 1400mm	2676	9124	44.0111	587.00	<b>704.40</b>
600 x 1600mm	3058	10427	44.0112	662.00	<b>794.40</b>



## Sub Section

# Aluminium

## Range

A huge variety of contemporary aluminium radiators and towel rails, from flat panel to ladder rail styles to suit any room.

Statement piece accessory towel hangers complement both vertical and horizontal designs allowing room for towels.

Contents			
Mersey Vertical, Available in 3 colours - <b>NEW PRODUCT</b>	182-183	Sandhurst Vertical & Horizontal, Available in 3 colours	218-220
Trent Vertical, Available in 3 colours - <b>NEW PRODUCT</b>	184-185	Berkeley Horizontal, Available in 3 colours	221
Addington Aluminium Type10, Gloss White & Matt Anthracite	186-189	Tordino Vertical & Horizontal, Available in 4 colours	222-225
Addington Aluminium Type20, Gloss White & Matt Anthracite	190-193	Guardia Vertical & Horizontal, Available in 4 colours	226-229
Charlton Vertical & Horizontal, Available in 3 colours	194-196	Hadleigh Vertical & Horizontal, Available in 3 colours	230-233
Charlton Towel Hangers	197	Vesima Vertical & Horizontal, Available in 3 colours	234-237
Withington Vertical & Horizontal, Available in 4 colours	198-200	Preston Vertical, Available in 3 colours	238-239
Withington Towel Hangers	201	Berlini Vertical, Available in 4 colours	240-241
Malmesbury Vertical & Horizontal, Available in 4 colours	202-204	Fairford Vertical & Horizontal, Matt White & Matt Anthracite	242-245
Malmesbury Towel Hangers	205	Burford Vertical & Horizontal, Matt White & Matt Anthracite	246-249
Rosano Vertical & Horizontal, Available in 3 colours	206-209	Kelmscott Vertical & Horizontal, Matt White & Matt Anthracite	250-253
Rosano Towel Hangers	210-211	Witney Vertical & Horizontal, Matt White & Matt Anthracite	254-255
Peretti Vertical & Horizontal, Available in 4 colours	212-215	Pelago Towel Rail, Available in 3 colours	256
Peretti Towel Hangers	216-217	Velor Towel Rail, Matt White & Matt Anthracite	257

# Aluminium Range

## MERSEY VERTICAL

Due in November 2023



Pictured 41.0450 Matt White with 41.0465 Towel Hangers



Brushed Brass colour setup

Pictured 41.0457 Matt Anthracite with 41.0472 Towel Hanger and 41.0722 Cover Caps x 2

A brand new addition to our range with ridged front panels that will stand out in every room, with a choice of towel hangers and your bathroom can also be heated while drying your towels. Available only in vertical sizes and 3 colours options.

### FEATURES

- Excellent heat conductivity and lightweight
- Only requires a low water volume
- Heats up very quickly
- Radiators come with chrome cover caps on top and bottom
- Not suitable for elements
- Tested to BS EN 442 standards
- 5 Year Manufacturer's Warranty\*

\* With conditions

Warranty

5  
Year

Heating



Technical Tables  
& Drawings

Page 360-361



### TECHNICAL INFORMATION

All measurements in Height by Width. Heat output based on  $\Delta T60^{\circ}\text{C}$ . For matching valves see pages 301-309. Corrosion inhibitor must be added to the heating system and maintained. Comes with pre-fitted flow diverter, fitted in the middle of the bottom header. For indirect heating systems only. Tappings are the width of the rail and 38mm off the wall. Projection from wall is 76mm.



# Aluminium Range

## MERSEY VERTICAL

Due in November 2023

### Mersey Vertical Aluminium Radiators - Matt White

Size H x W	Watts	BTU	Code	£ Ex VAT	£ Inc VAT
1800 x 280mm	776	2647	41.0449	236.00	<b>283.20</b>
1800 x 375mm	1034	3528	41.0450	289.00	<b>346.80</b>
1800 x 470mm	1293	4412	41.0451	344.00	<b>412.80</b>
1800 x 565mm	1552	5295	41.0452	398.00	<b>477.60</b>
1800 x 660mm	1810	6176	41.0453	439.00	<b>526.80</b>

### Mersey Vertical Aluminium Radiators - Matt Anthracite

Size H x W	Watts	BTU	Code	£ Ex VAT	£ Inc VAT
1800 x 280mm	776	2647	41.0454	236.00	<b>283.20</b>
1800 x 375mm	1034	3528	41.0455	289.00	<b>346.80</b>
1800 x 470mm	1293	4412	41.0456	344.00	<b>412.80</b>
1800 x 565mm	1552	5295	41.0457	398.00	<b>477.60</b>
1800 x 660mm	1810	6176	41.0458	439.00	<b>526.80</b>

### Mersey Vertical Aluminium Radiators - Matt Black

Size H x W	Watts	BTU	Code	£ Ex VAT	£ Inc VAT
1800 x 280mm	776	2647	41.0459	236.00	<b>283.20</b>
1800 x 375mm	1034	3528	41.0460	289.00	<b>346.80</b>
1800 x 470mm	1293	4412	41.0461	344.00	<b>412.80</b>
1800 x 565mm	1552	5295	41.0462	398.00	<b>477.60</b>
1800 x 660mm	1810	6176	41.0463	439.00	<b>526.80</b>

Prices include radiator and wall fixing sets, valves and accessories extra.



### Mersey Cover Cap Sets - Un-Brushed Brass

Description	Code	£ Ex VAT	£ Inc VAT
Cover Cap Set 280mm	41.0719	9.00	<b>10.80</b>
Cover Cap Set 375mm	41.0720	11.00	<b>13.20</b>
Cover Cap Set 470mm	41.0721	13.00	<b>15.60</b>
Cover Cap Set 565mm	41.0722	16.00	<b>19.20</b>
Cover Cap Set 660mm	41.0723	18.00	<b>21.60</b>

Cover cap sets only include cover caps for the top or bottom of the radiator.



Pictured 41.0461 Matt Black



### Towel Hanger - Mirror Polished Premium

Description	Code	£ Ex VAT	£ Inc VAT
Towel Hanger 280mm	41.0464	53.00	<b>63.60</b>
Towel Hanger 375mm	41.0465	58.00	<b>69.60</b>
Towel Hanger 470mm	41.0466	63.00	<b>75.60</b>
Towel Hanger 565mm	41.0467	69.00	<b>82.80</b>
Towel Hanger 660mm	41.0468	74.00	<b>88.80</b>



### Towel Hanger - Brushed Brass

Description	Code	£ Ex VAT	£ Inc VAT
Towel Hanger 280mm	41.0469	53.00	<b>63.60</b>
Towel Hanger 375mm	41.0470	55.00	<b>66.00</b>
Towel Hanger 470mm	41.0471	58.00	<b>69.60</b>
Towel Hanger 565mm	41.0472	62.00	<b>74.40</b>
Towel Hanger 660mm	41.0473	66.00	<b>79.20</b>

# Aluminium Range

## TRENT VERTICAL

Due in November 2023

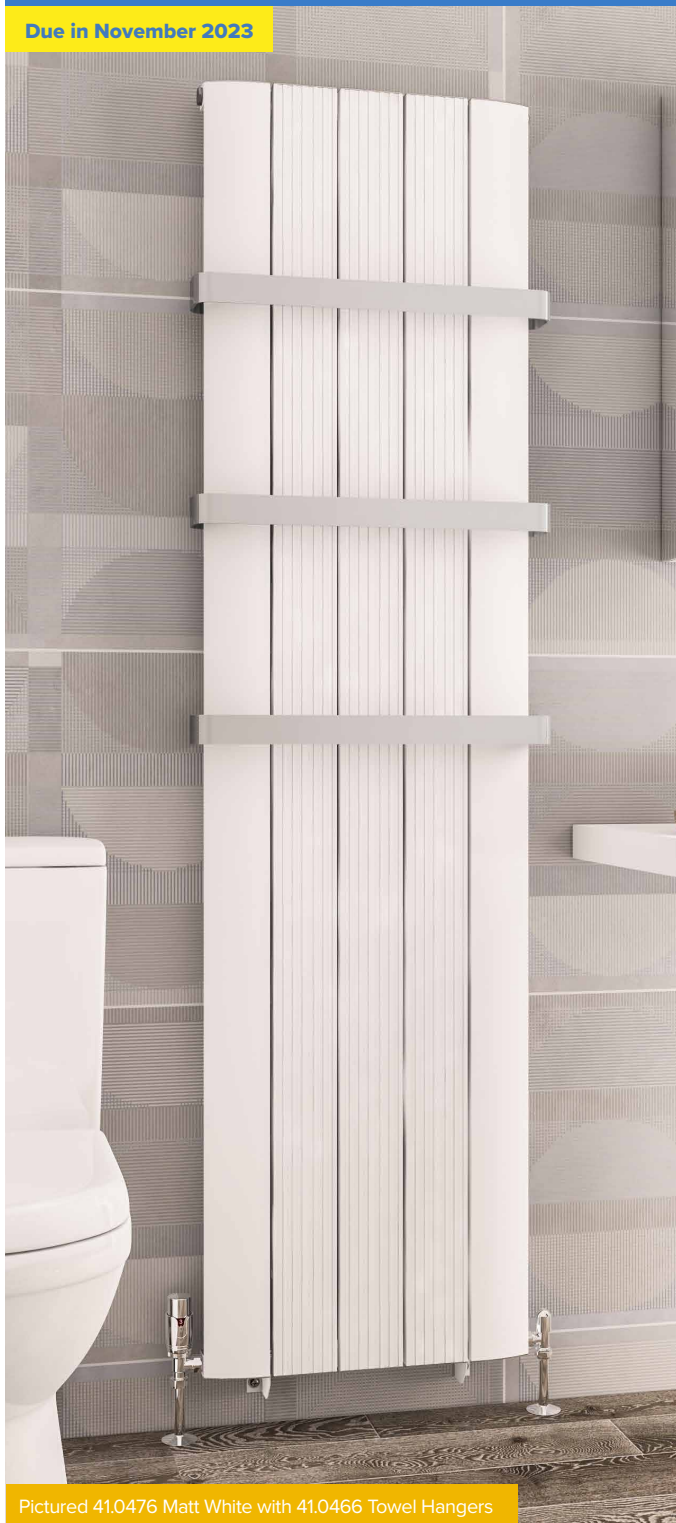

Pictured 41.0476 Matt White with 41.0466 Towel Hangers



Pictured 41.0482 Matt Anthracite

A brand new addition to our range with ridged front panels and curved flat end panels that will stand out in every room, with a choice of towel hangers and your bathroom can also be heated while drying your towels. Available only in vertical sizes and 3 colour options.

### FEATURES

- Excellent heat conductivity and lightweight
  - Only requires a low water volume
  - Heats up very quickly
  - Radiators come with chrome cover caps on top and bottom
  - Not suitable for elements
  - Tested to BS EN 442 standards
  - 5 Year Manufacturer's Warranty\*
- \* With conditions

Technical Tables  
& Drawings  
Page 360-361



Warranty

5  
Year

Heating



### TECHNICAL INFORMATION

All measurements in Height by Width. Heat output based on  $\Delta T60^{\circ}\text{C}$ . For matching valves see pages 301-309. Corrosion inhibitor must be added to the heating system and maintained. Comes with pre-fitted flow diverter, fitted in the middle of the bottom header. For indirect heating systems only. Tappings are the width of the rail and 38mm off the wall. Projection from wall is 76mm.

# Aluminium Range

## TRENT VERTICAL

Due in November 2023

Brushed Brass colour setup

Trent Vertical Aluminium Radiators - Matt White					
Size H x W	Watts	BTU	Code	£ Ex VAT	£ Inc VAT
1800 x 280mm	762	2600	41.0474	220.00	<b>264.00</b>
1800 x 375mm	1017	3470	41.0475	273.00	<b>327.60</b>
1800 x 470mm	1271	4337	41.0476	329.00	<b>394.80</b>
1800 x 565mm	1525	5203	41.0477	383.00	<b>459.60</b>
1800 x 660mm	1779	6070	41.0478	426.00	<b>511.20</b>

Trent Vertical Aluminium Radiators - Matt Anthracite					
Size H x W	Watts	BTU	Code	£ Ex VAT	£ Inc VAT
1800 x 280mm	762	2600	41.0479	220.00	<b>264.00</b>
1800 x 375mm	1017	3470	41.0480	273.00	<b>327.60</b>
1800 x 470mm	1271	4337	41.0481	329.00	<b>394.80</b>
1800 x 565mm	1525	5203	41.0482	383.00	<b>459.60</b>
1800 x 660mm	1779	6070	41.0483	426.00	<b>511.20</b>

Trent Vertical Aluminium Radiators - Matt Black					
Size H x W	Watts	BTU	Code	£ Ex VAT	£ Inc VAT
1800 x 280mm	762	2600	41.0484	220.00	<b>264.00</b>
1800 x 375mm	1017	3470	41.0485	273.00	<b>327.60</b>
1800 x 470mm	1271	4337	41.0486	329.00	<b>394.80</b>
1800 x 565mm	1525	5203	41.0487	383.00	<b>459.60</b>
1800 x 660mm	1779	6070	41.0488	426.00	<b>511.20</b>

Prices include radiator and wall fixing sets, valves and accessories extra.



### Trent Cover Cap Sets - Un-Brushed Brass

Description	Code	£ Ex VAT	£ Inc VAT
Cover Cap Set 280mm	41.0724	9.00	<b>10.80</b>
Cover Cap Set 375mm	41.0725	11.00	<b>13.20</b>
Cover Cap Set 470mm	41.0726	13.00	<b>15.60</b>
Cover Cap Set 565mm	41.0727	15.00	<b>18.00</b>
Cover Cap Set 660mm	41.0728	18.00	<b>21.60</b>

Cover cap sets only include cover caps for the top or bottom of the radiator.



Pictured 41.0485 Matt Black with 41.0470 Towel Hangers and 41.0725 Cover Caps x 2

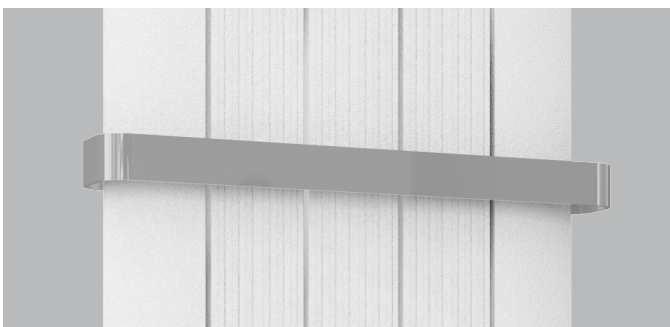

### Towel Hanger - Mirror Polished Premium

Description	Code	£ Ex VAT	£ Inc VAT
Towel Hanger 280mm	41.0464	53.00	<b>63.60</b>
Towel Hanger 375mm	41.0465	58.00	<b>69.60</b>
Towel Hanger 470mm	41.0466	63.00	<b>75.60</b>
Towel Hanger 565mm	41.0467	69.00	<b>82.80</b>
Towel Hanger 660mm	41.0468	74.00	<b>88.80</b>



### Towel Hanger - Brushed Brass

Description	Code	£ Ex VAT	£ Inc VAT
Towel Hanger 280mm	41.0469	53.00	<b>63.60</b>
Towel Hanger 375mm	41.0470	55.00	<b>66.00</b>
Towel Hanger 470mm	41.0471	58.00	<b>69.60</b>
Towel Hanger 565mm	41.0472	62.00	<b>74.40</b>
Towel Hanger 660mm	41.0473	66.00	<b>79.20</b>

# Aluminium Range

## ADDINGTON ALUMINIUM TYPE 10 - GLOSS WHITE



Pictured 86.0372 Gloss White with 91.0113 Towel Hanger



Pictured 86.0360 Gloss White with 91.0082 Towel Hanger



Warranty  
**5**  
Year

Heating  

All Electric  

Dual-Fuel  

Pictured 86.0358 Gloss White

Bar Dimensions (mm)  
Vertical Bars 70 x 11mm

# Aluminium Range

## ADDINGTON ALUMINIUM TYPE 10 - GLOSS WHITE

A luxurious flat panelled radiator range with stunning clean lines which will be the focus of any room is now available also in aluminium. Available in horizontal or vertical sizes and different heights. Stunning towel hangers will complement the vertical design allowing room for your towels.

### FEATURES

- Excellent heat conductivity and lightweight
- Only requires a low water volume
- Heats up very quickly
- Tested to BS EN 442 standards
- 5 Year Manufacturer's Warranty\*
- Can be single or dual fuel, or all electric
- Radiators come with cover caps on top and bottom, the same colour as the radiator

\* With conditions

### Technical Tables & Drawings

Page 366-367



### 500mm Height

#### Addington Aluminium Type 10 Radiators - Gloss White

Size H x W	Watts	BTU	Element Output	Element Type	Code	£ Ex VAT	£ Inc VAT
500 x 514mm	443	1512	150W	A	86.0348	301.00	361.20
500 x 588mm	507	1728	150W	A	86.0349	331.00	397.20

### 600mm Height

#### Addington Aluminium Type 10 Radiators - Gloss White

Size H x W	Watts	BTU	Element Output	Element Type	Code	£ Ex VAT	£ Inc VAT
600 x 292mm	315	1074	150W	A	86.0350	223.00	267.60
600 x 366mm	393	1342	150W	A	86.0351	258.00	309.60
600 x 440mm	472	1610	150W	A	86.0352	291.00	349.20
600 x 514mm	551	1879	300W	A	86.0353	326.00	391.20
600 x 588mm	629	2147	300W	A	86.0354	361.00	433.20
600 x 662mm	708	2416	300W	A	86.0355	395.00	474.00
600 x 810mm	865	2952	300W	A	86.0356	462.00	554.40
600 x 1032mm	1101	3758	600W	A	86.0357	569.00	682.80
600 x 1180mm	1259	4294	600W	A	86.0358	636.00	763.20
600 x 1254mm	1337	4563	600W	A	86.0359	666.00	799.20

### 800mm Height

#### Addington Aluminium Type10 Radiators - Gloss White

Size H x W	Watts	BTU	Element Output	Element Type	Code	£ Ex VAT	£ Inc VAT
800 x 514mm	709	2420	300W	A	86.0360	375.00	450.00
800 x 588mm	811	2766	300W	A	86.0361	416.00	499.20

### 1000mm Height

#### Addington Aluminium Type 10 Radiators - Gloss White

Size H x W	Watts	BTU	Element Output	Element Type	Code	£ Ex VAT	£ Inc VAT
1000 x 514mm	862	2940	300W	A	86.0362	427.00	512.40
1000 x 588mm	985	3360	300W	A	86.0363	474.00	568.80

### 1200mm Height

#### Addington Aluminium Type 10 Radiators - Gloss White

Size H x W	Watts	BTU	Element Output	Element Type	Code	£ Ex VAT	£ Inc VAT
1200 x 514mm	1010	3446	300W	A	86.0364	477.00	572.40
1200 x 588mm	1154	3938	600W	A	86.0365	532.00	638.40

### 1400mm Height

#### Addington Aluminium Type 10 Radiators - Gloss White

Size H x W	Watts	BTU	Element Output	Element Type	Code	£ Ex VAT	£ Inc VAT
1400 x 514mm	1154	3937	600W	A	86.0366	527.00	632.40
1400 x 588mm	1319	4499	600W	A	86.0367	587.00	704.40

### 1800mm Height

#### Addington Aluminium Type 10 Radiators - Gloss White

Size H x W	Watts	BTU	Element Output	Element Type	Code	£ Ex VAT	£ Inc VAT
1800 x 292mm	816	2786	600W	A	86.0368	396.00	475.20
1800 x 366mm	1021	3482	600W	A	86.0369	472.00	566.40
1800 x 440mm	1225	4179	600W	A	86.0370	543.00	651.60
1800 x 514mm	1429	4875	900W	A	86.0371	617.00	740.40
1800 x 588mm	1633	5572	900W	A	86.0372	686.00	823.20

### Towel Hangers

Page 149



### TECHNICAL INFORMATION

All measurements in Height by Width. Heat output based on  $\Delta T_{60}^{\circ}\text{C}$ . For matching valves see pages 301-309. Corrosion inhibitor must be added to the heating system and maintained. Flow diverter must only be fitted when radiator installed on central heating system. For indirect heating systems only. Tappings are the width of the rail and 45mm off the wall.

For element types see pages 288-300.

For 500 and 600mm Heights : Element can only be installed horizontally on the bottom header. Radiators that are electric only are restricted to the heat output of the elements.



For element types see pages 288-300.

For 800, 1000, 1200, 1400 and 1800mm Heights: Element can be installed vertically on the right-hand or left-hand side on the bottom header. Radiators that are electric only are restricted to the heat output of the elements. For dual fuel installations, element must be installed on flow side.



Single profile construction

### Radiator Valves

Page 301-309

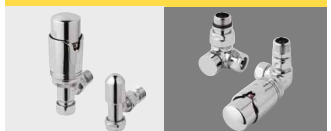

## ADDINGTON ALUMINIUM TYPE10 COVER CAP SETS - CHROME



### Addington Aluminium Type10 Cover Cap Sets - Chrome



Description	Code	£ Ex VAT	£ Inc VAT
Cover Cap Set 292mm	86.0426	34.00	40.80
Cover Cap Set 366mm	86.0427	39.00	46.80
Cover Cap Set 440mm	86.0428	42.00	50.40
Cover Cap Set 514mm	86.0429	49.00	58.80
Cover Cap Set 588mm	86.0430	53.00	63.60
Cover Cap Set 662mm	86.0431	56.00	67.20
Cover Cap Set 810mm	86.0432	67.00	80.40
Cover Cap Set 1032mm	86.0433	81.00	97.20
Cover Cap Set 1180mm	86.0434	91.00	109.20
Cover Cap Set 1254mm	86.0435	96.00	115.20

Cover cap sets only include cover caps for the top of the radiator.

# Aluminium Range

## ADDINGTON ALUMINIUM TYPE 10 - MATT ANTHRACITE



<b>Warranty</b> <b>5</b> Year	<b>Heating</b> 	<b>All Electric</b> 	<b>Dual-Fuel</b> 
-------------------------------------	---	--	---

Pictured 86.0395 Matt Anthracite with 91.0086 Towel Hangers x2



Pictured 86.0379 Matt Anthracite with 91.0093 Towel Hanger



**Bar Dimensions (mm)**

Vertical Bars 70 x 11mm

Pictured 86.0382 Matt Anthracite

# Aluminium Range

## ADDINGTON ALUMINIUM TYPE 10 - MATT ANTHRACITE

A luxurious flat panelled radiator range with stunning clean lines which will be the focus of any room is now available also in aluminium. Available in horizontal or vertical sizes and different heights. Stunning towel hangers will complement the vertical design allowing room for your towels.

### FEATURES

- Excellent heat conductivity and lightweight
- Only requires a low water volume
- Heats up very quickly
- Tested to BS EN 442 standards
- 5 Year Manufacturer's Warranty\*
- Can be single or dual fuel, or all electric
- Radiators come with cover caps on top and bottom, the same colour as the radiator
- \* With conditions

### Technical Tables & Drawings

Page 366-367



### 500mm Height

#### Addington Aluminium Type 10 Radiators - Matt Anthracite

Size H x W	Watts	BTU	Element Output	Element Type	Code	£ Ex VAT	£ Inc VAT
500 x 514mm	443	1512	150W	A	86.0373	301.00	361.20
500 x 588mm	507	1728	150W	A	86.0374	331.00	397.20

### 600mm Height

#### Addington Aluminium Type 10 Radiators - Matt Anthracite

Size H x W	Watts	BTU	Element Output	Element Type	Code	£ Ex VAT	£ Inc VAT
600 x 292mm	315	1074	150W	A	86.0375	223.00	267.60
600 x 366mm	393	1342	150W	A	86.0376	258.00	309.60
600 x 440mm	472	1610	150W	A	86.0377	291.00	349.20
600 x 514mm	551	1879	300W	A	86.0378	326.00	391.20
600 x 588mm	629	2147	300W	A	86.0379	361.00	433.20
600 x 662mm	708	2416	300W	A	86.0380	395.00	474.00
600 x 810mm	865	2952	300W	A	86.0381	462.00	554.40
600 x 1032mm	1101	3758	600W	A	86.0382	569.00	682.80
600 x 1180mm	1259	4294	600W	A	86.0383	636.00	763.20
600 x 1254mm	1337	4563	600W	A	86.0384	666.00	799.20

### 800mm Height

#### Addington Aluminium Type 10 Radiators - Matt Anthracite

Size H x W	Watts	BTU	Element Output	Element Type	Code	£ Ex VAT	£ Inc VAT
800 x 514mm	709	2420	300W	A	86.0385	375.00	450.00
800 x 588mm	811	2766	300W	A	86.0386	416.00	499.20

### 1000mm Height

#### Addington Aluminium Type 10 Radiators - Matt Anthracite

Size H x W	Watts	BTU	Element Output	Element Type	Code	£ Ex VAT	£ Inc VAT
1000 x 514mm	862	2940	300W	A	86.0387	427.00	512.40
1000 x 588mm	985	3360	300W	A	86.0388	474.00	568.80

### 1200mm Height

#### Addington Aluminium Type 10 Radiators - Matt Anthracite

Size H x W	Watts	BTU	Element Output	Element Type	Code	£ Ex VAT	£ Inc VAT
1200 x 514mm	1010	3446	300W	A	86.0389	477.00	572.40
1200 x 588mm	1154	3938	600W	A	86.0390	532.00	638.40

### 1400mm Height

#### Addington Aluminium Type 10 Radiators - Matt Anthracite

Size H x W	Watts	BTU	Element Output	Element Type	Code	£ Ex VAT	£ Inc VAT
1400 x 514mm	1154	3937	600W	A	86.0391	527.00	632.40
1400 x 588mm	1319	4499	600W	A	86.0392	587.00	704.40

### 1800mm Height

#### Addington Aluminium Type 10 Radiators - Matt Anthracite

Size H x W	Watts	BTU	Element Output	Element Type	Code	£ Ex VAT	£ Inc VAT
1800 x 292mm	816	2786	600W	A	86.0393	396.00	475.20
1800 x 366mm	1021	3482	600W	A	86.0394	472.00	566.40
1800 x 440mm	1225	4179	600W	A	86.0395	543.00	651.60
1800 x 514mm	1429	4875	900W	A	86.0396	617.00	740.40
1800 x 588mm	1633	5572	900W	A	86.0397	686.00	823.20

### Towel Hangers

Page 149

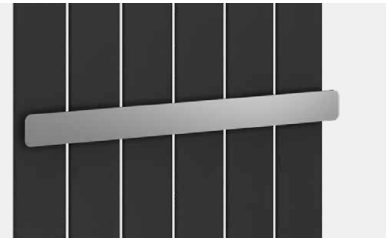

### TECHNICAL INFORMATION

All measurements in Height by Width. Heat output based on  $\Delta T60^{\circ}\text{C}$ . For matching valves see pages 301-309. Corrosion inhibitor must be added to the heating system and maintained. Flow diverter must only be fitted when radiator installed on central heating system. For indirect heating systems only. Tappings are the width of the rail and 45mm off the wall.

For element types see pages 288-300.

For 500 and 600mm Heights : Element can only be installed horizontally on the bottom header. Radiators that are electric only are restricted to the heat output of the elements.



For element types see pages 288-300.

For 800, 1000, 1200, 1400 and 1800mm Heights: Element can be installed vertically on the right-hand or left-hand side on the bottom header. Radiators that are electric only are restricted to the heat output of the elements. For dual fuel installations, element must be installed on flow side.



Single profile construction

### Radiator Valves

Page 301-309



## ADDINGTON ALUMINIUM TYPE 10 COVER CAP SETS - CHROME



### Addington Aluminium Type 10 Cover Cap Sets - Chrome



Description	Code	£ Ex VAT	£ Inc VAT
Cover Cap Set 292mm	86.0426	34.00	40.80
Cover Cap Set 366mm	86.0427	39.00	46.80
Cover Cap Set 440mm	86.0428	42.00	50.40
Cover Cap Set 514mm	86.0429	49.00	58.80
Cover Cap Set 588mm	86.0430	53.00	63.60
Cover Cap Set 662mm	86.0431	56.00	67.20
Cover Cap Set 810mm	86.0432	67.00	80.40
Cover Cap Set 1032mm	86.0433	81.00	97.20
Cover Cap Set 1180mm	86.0434	91.00	109.20
Cover Cap Set 1254mm	86.0435	96.00	115.20

Cover cap sets only include cover caps for the top of the radiator.

# Aluminium Range

## ADDINGTON ALUMINIUM TYPE 20 - GLOSS WHITE



<b>Warranty</b> <b>5</b> Year	<b>Heating</b> 	<b>All Electric</b> 	<b>Dual-Fuel</b> 
-------------------------------------	---	--	---

Pictured 86.0409 Gloss White



Pictured 86.0402 Gloss White

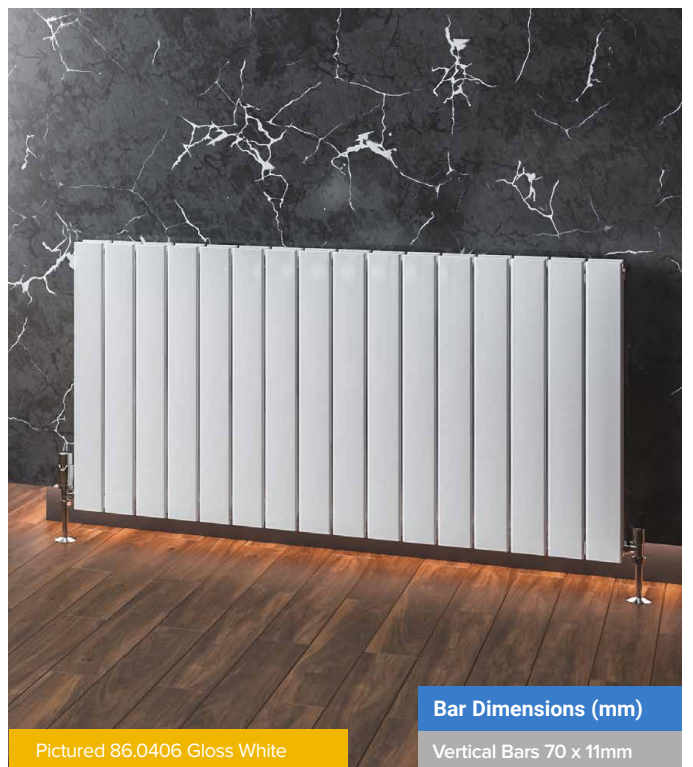

Pictured 86.0406 Gloss White

Bar Dimensions (mm)

Vertical Bars 70 x 11mm



# Aluminium Range

## ADDINGTON ALUMINIUM TYPE 20 - GLOSS WHITE

A luxurious double flat panelled radiator range with stunning clean lines which will be the focus of any room is now available also in aluminium. Available in horizontal or vertical sizes and different heights.

### FEATURES

- Excellent heat conductivity and lightweight
- Only requires a low water volume
- Heats up very quickly
- Tested to BS EN 442 standards
- 5 Year Manufacturer's Warranty\*
- Can be single or dual fuel, or all electric
- Radiators come with cover caps on top and bottom, the same colour as the radiator
- \* With conditions

### Technical Tables & Drawings

Page 366-367



### 600mm Height

#### Addington Aluminium Type 20 Radiators - Gloss White

Size H x W	Watts	BTU	Element Output	Element Type	Code	£ Ex VAT	£ Inc VAT
600 x 292mm	442	1509	150W	A	86.0398	283.00	339.60
600 x 366mm	553	1887	300W	A	86.0399	329.00	394.80
600 x 440mm	664	2264	300W	A	86.0400	374.00	448.80
600 x 514mm	774	2641	300W	A	86.0401	424.00	508.80
600 x 588mm	885	3019	300W	A	86.0402	472.00	566.40
600 x 662mm	995	3396	300W	A	86.0403	527.00	632.40
600 x 810mm	1216	4151	600W	A	86.0404	622.00	746.40
600 x 1032mm	1548	5283	600W	A	86.0405	767.00	920.40
600 x 1180mm	1769	6038	900W	A	86.0406	864.00	1036.80
600 x 1254mm	1880	6415	900W	A	86.0407	915.00	1098.00

### 1800mm Height

#### Addington Aluminium Type 20 Radiators - Gloss White

Size H x W	Watts	BTU	Element Output	Element Type	Code	£ Ex VAT	£ Inc VAT
1800 x 366mm	1435	4896	600W	A	86.0408	680.00	816.00
1800 x 440mm	1722	5875	900W	A	86.0409	808.00	969.60
1800 x 514mm	2009	6854	900W	A	86.0410	947.00	1136.40
1800 x 588mm	2296	7834	900W	A	86.0411	1074.00	1288.80



Double profile construction

### Multi-Purpose Towel Hangers

Page 312



### TECHNICAL INFORMATION

All measurements in Height by Width. Heat output based on  $\Delta T 60^{\circ}\text{C}$ . For matching valves see pages 301-309. Corrosion inhibitor must be added to the heating system and maintained. Flow diverter must only be fitted when radiator installed on central heating system. For indirect heating systems only. Tappings are the width of the rail and 65mm off the wall.

For element types see pages 288-300.

For 600mm Heights : Element can only be installed horizontally on the bottom header. Radiators that are electric only are restricted to the heat output of the elements.



For element types see pages 288-300.

For 1800mm Heights: Element can be installed vertically on the right-hand or left-hand side on the bottom header. Radiators that are electric only are restricted to the heat output of the elements. For dual fuel installations, element must be installed on flow side.



### Radiator Valves

Page 301-309



## ADDINGTON ALUMINIUM TYPE 20 COVER CAP SETS - CHROME



### Addington Aluminium Type 20 Cover Cap Sets - Chrome

Description	Code	£ Ex VAT	£ Inc VAT
Cover Cap Set 292mm	86.0436	53.00	63.60
Cover Cap Set 366mm	86.0437	62.00	74.40
Cover Cap Set 440mm	86.0438	74.00	88.80
Cover Cap Set 514mm	86.0439	81.00	97.20
Cover Cap Set 588mm	86.0440	91.00	109.20
Cover Cap Set 662mm	86.0441	101.00	121.20
Cover Cap Set 810mm	86.0442	121.00	145.20
Cover Cap Set 1032mm	86.0443	149.00	178.80
Cover Cap Set 1180mm	86.0444	167.00	200.40
Cover Cap Set 1254mm	86.0445	156.00	187.20

Cover cap sets only include cover caps for the top of the radiator.

# Aluminium Range

## ADDINGTON ALUMINIUM TYPE 20 - MATT ANTHRACITE



Pictured 86.0425 Matt Anthracite

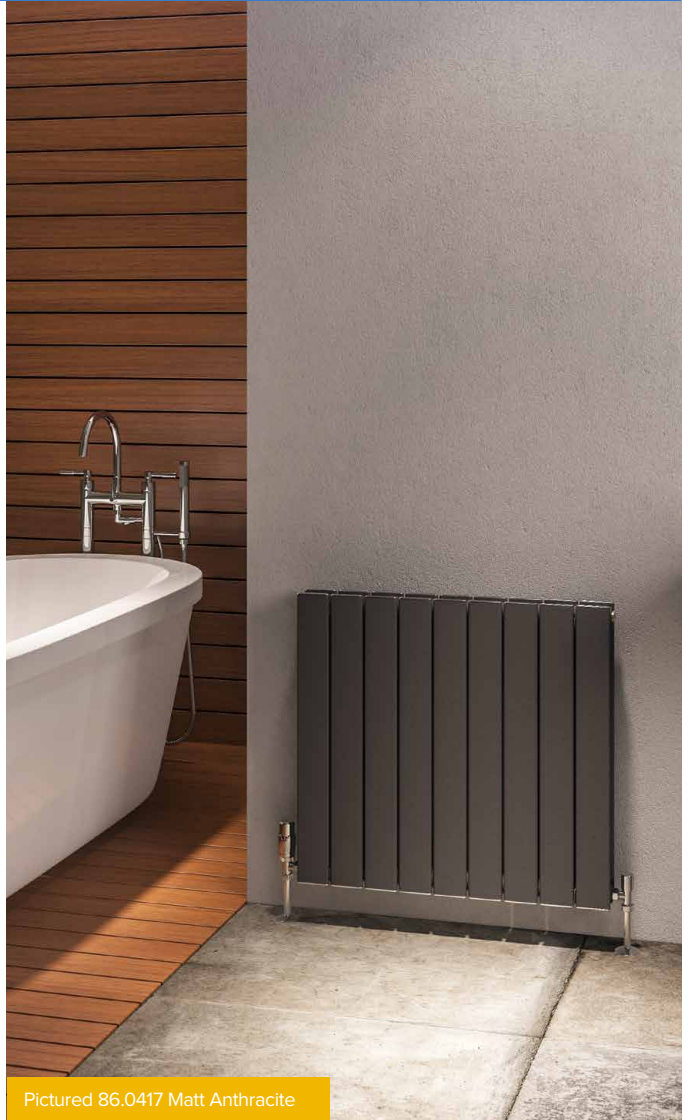

Pictured 86.0417 Matt Anthracite

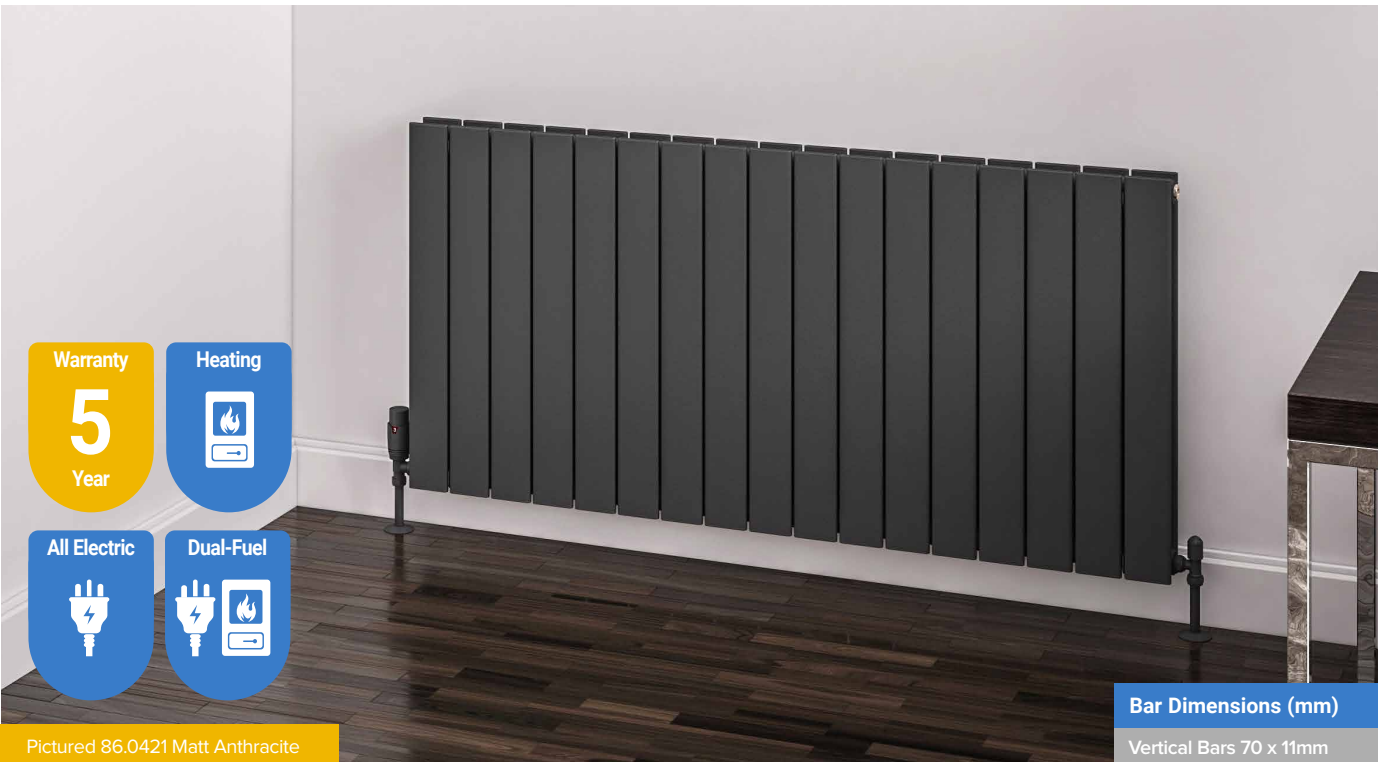

Warranty  
**5**  
Year

Heating  

All Electric  

Dual-Fuel  

Pictured 86.0421 Matt Anthracite

Bar Dimensions (mm)

Vertical Bars 70 x 11mm

# Aluminium Range

## ADDINGTON ALUMINIUM TYPE 20 - MATT ANTHRACITE

A luxurious double flat panelled radiator range with stunning clean lines which will be the focus of any room is now available also in aluminium. Available in horizontal or vertical sizes and different heights.

### FEATURES

- Excellent heat conductivity and lightweight
  - Only requires a low water volume
  - Heats up very quickly
  - Tested to BS EN 442 standards
  - 5 Year Manufacturer's Warranty\*
  - Can be single or dual fuel, or all electric
  - Radiators come with cover caps on top and bottom, the same colour as the radiator
- \* With conditions

### Technical Tables & Drawings

Page 366-367



### 600mm Height

#### Addington Aluminium Type 20 Radiators - Matt Anthracite

Size H x W	Watts	BTU	Element Output	Element Type	Code	£ Ex VAT	£ Inc VAT
600 x 292mm	442	1509	150W	A	86.0412	283.00	<b>339.60</b>
600 x 366mm	553	1887	300W	A	86.0413	329.00	<b>394.80</b>
600 x 440mm	664	2264	300W	A	86.0414	374.00	<b>448.80</b>
600 x 514mm	774	2641	300W	A	86.0415	424.00	<b>508.80</b>
600 x 588mm	885	3019	300W	A	86.0416	472.00	<b>566.40</b>
600 x 662mm	995	3396	300W	A	86.0417	527.00	<b>632.40</b>
600 x 810mm	1216	4151	600W	A	86.0418	622.00	<b>746.40</b>
600 x 1032mm	1548	5283	600W	A	86.0419	767.00	<b>920.40</b>
600 x 1180mm	1769	6038	900W	A	86.0420	864.00	<b>1036.80</b>
600 x 1254mm	1880	6415	900W	A	86.0421	915.00	<b>1098.00</b>

### 1800mm Height

#### Addington Aluminium Type 20 Radiators - Matt Anthracite

Size H x W	Watts	BTU	Element Output	Element Type	Code	£ Ex VAT	£ Inc VAT
1800 x 366mm	1435	4896	600W	A	86.0422	680.00	<b>816.00</b>
1800 x 440mm	1722	5875	900W	A	86.0423	808.00	<b>969.60</b>
1800 x 514mm	2009	6854	900W	A	86.0424	947.00	<b>1136.40</b>
1800 x 588mm	2296	7834	900W	A	86.0425	1074.00	<b>1288.80</b>



Double profile construction

### Multi-Purpose Towel Hangers

Page 312



### TECHNICAL INFORMATION

All measurements in Height by Width. Heat output based on  $\Delta T60^{\circ}\text{C}$ . For matching valves see pages 301-309. Corrosion inhibitor must be added to the heating system and maintained. Flow diverter must only be fitted when radiator installed on central heating system. For indirect heating systems only. Tappings are the width of the rail and 65mm off the wall.

For element types  
see pages 288-300.

For 600mm Heights :  
Element can only be installed  
horizontally on the bottom header.  
**Radiators that are electric only are  
restricted to the heat output  
of the elements.**



For element types  
see pages 288-300.

For 1800mm Heights: Element can be  
installed vertically on the right-hand or left-  
hand side on the bottom header. **Radiators  
that are electric only are restricted to the  
heat output of the elements.** For dual fuel  
installations, element must be installed on  
flow side.



### Radiator Valves

Page 301-309



## ADDINGTON ALUMINIUM TYPE 20 COVER CAP SETS - CHROME



### Addington Aluminium Type 20 Cover Cap Sets - Chrome

Description	Code	£ Ex VAT	£ Inc VAT
Cover Cap Set 292mm	86.0436	<b>53.00</b>	<b>63.60</b>
Cover Cap Set 366mm	86.0437	<b>62.00</b>	<b>74.40</b>
Cover Cap Set 440mm	86.0438	<b>74.00</b>	<b>88.80</b>
Cover Cap Set 514mm	86.0439	<b>81.00</b>	<b>97.20</b>
Cover Cap Set 588mm	86.0440	<b>91.00</b>	<b>109.20</b>
Cover Cap Set 662mm	86.0441	<b>101.00</b>	<b>121.20</b>
Cover Cap Set 810mm	86.0442	<b>121.00</b>	<b>145.20</b>
Cover Cap Set 1032mm	86.0443	<b>149.00</b>	<b>178.80</b>
Cover Cap Set 1180mm	86.0444	<b>167.00</b>	<b>200.40</b>
Cover Cap Set 1254mm	86.0445	<b>156.00</b>	<b>187.20</b>

Cover cap sets only include cover caps for the top of the radiator.

# Aluminium Range

## CHARLTON VERTICAL



Pictured 89.0128 Matt White with 89.0134 Towel Hangers x3

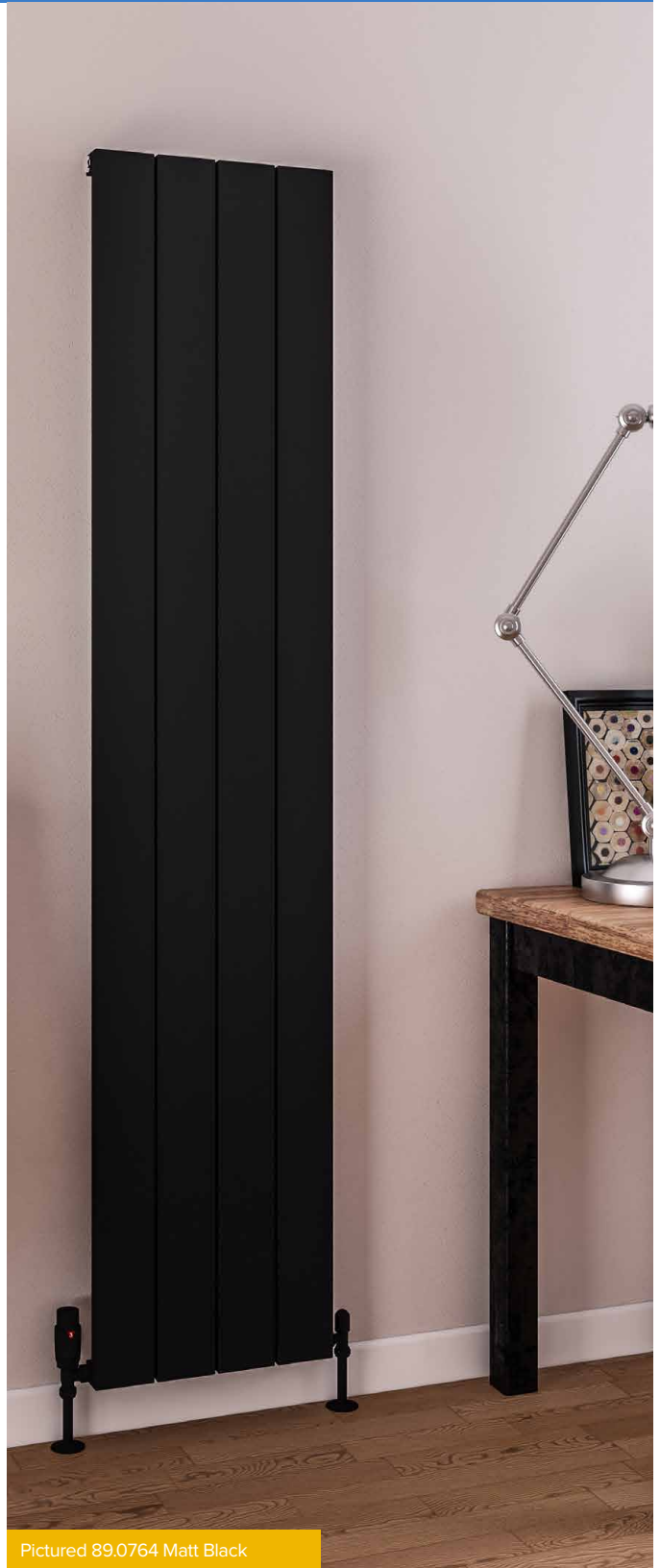

Pictured 89.0764 Matt Black

A contemporary versatile radiator style, that come in a variety of sizes and three finishes, with an optional extra of stylish towel hangers.

All Electric

Dual-Fuel

Warranty

**5**

Year

Heating

### FEATURES

- Excellent heat conductivity and lightweight
- Only requires a low water volume
- Heats up very quickly
- Radiators come with cover caps on top and bottom, same as radiator colour.
- Can be single, dual fuel or all electric
- Tested to BS EN 442 standards
- 5 Year Manufacturer's Warranty\*
- \* With conditions

### Technical Tables & Drawings

Page 362-363



# Aluminium Range

## CHARLTON VERTICAL



Matt White

Matt Anthracite

Matt Black

### Charlton Vertical Aluminium Radiators - Matt White

Size H x W	Watts	BTU	Element Output	Element Type	Code	£ Ex VAT	£ Inc VAT
600 x 280mm	305	1041	150W	A, A+, F, G	89.0758	182.00	218.40
1200 x 280mm	585	1997	300W	A, A+, F, G	89.0925	251.00	301.20
1200 x 375mm	775	2645	300W	A, A+, F, G	89.0926	323.00	387.60
1200 x 470mm	963	3286	450W	A, A+, F, G	89.0927	395.00	474.00
1200 x 565mm	1150	3924	600W	A, A+, F, G	89.0928	472.00	566.40
1800 x 280mm	844	2880	450W	A, A+, F, G	89.0128	307.00	368.40
1800 x 375mm	1119	3819	600W	A, A+, F, G	89.0130	397.00	476.40
1800 x 470mm	1391	4747	750W	A, A+, F, G	89.0132	479.00	574.80
1800 x 565mm	1661	5668	1000W	A, A+, F, G	89.0759	595.00	714.00

### Charlton Vertical Aluminium Radiators - Matt Anthracite

Size H x W	Watts	BTU	Element Output	Element Type	Code	£ Ex VAT	£ Inc VAT
600 x 280mm	305	1041	150W	A, A+, F, G	89.0760	182.00	218.40
1200 x 280mm	585	1997	300W	A, A+, F, G	89.0958	251.00	301.20
1200 x 375mm	775	2645	300W	A, A+, F, G	89.0959	323.00	387.60
1200 x 470mm	963	3286	450W	A, A+, F, G	89.0960	395.00	474.00
1200 x 565mm	1150	3924	600W	A, A+, F, G	89.0961	472.00	566.40
1800 x 280mm	844	2880	450W	A, A+, F, G	89.0129	307.00	368.40
1800 x 375mm	1119	3819	600W	A, A+, F, G	89.0131	397.00	476.40
1800 x 470mm	1391	4747	750W	A, A+, F, G	89.0133	479.00	574.80
1800 x 565mm	1661	5668	1000W	A, A+, F, G	89.0761	595.00	714.00

### Charlton Vertical Aluminium Radiators - Matt Black

Size H x W	Watts	BTU	Element Output	Element Type	Code	£ Ex VAT	£ Inc VAT
600 x 280mm	305	1041	150W	A, A+, F, G	89.0762	182.00	218.40
1200 x 280mm	585	1997	300W	A, A+, F, G	89.0979	251.00	301.20
1200 x 375mm	775	2645	300W	A, A+, F, G	89.0980	323.00	387.60
1200 x 470mm	963	3286	450W	A, A+, F, G	89.0981	395.00	474.00
1200 x 565mm	1150	3924	600W	A, A+, F, G	89.0982	472.00	566.40
1800 x 280mm	844	2880	450W	A, A+, F, G	89.0763	307.00	368.40
1800 x 375mm	1119	3819	600W	A, A+, F, G	89.0764	397.00	476.40
1800 x 470mm	1391	4747	750W	A, A+, F, G	89.0765	479.00	574.80
1800 x 565mm	1661	5668	1000W	A, A+, F, G	89.0766	595.00	714.00

Prices include radiator and wall fixing sets, valves and accessories extra.

### TECHNICAL INFORMATION

All measurements in Height by Width. Heat output based on  $\Delta T60^{\circ}\text{C}$ . For matching valves see pages 301-309. Corrosion inhibitor must be added to the heating system and maintained. Flow diverter must only be fitted when radiator installed on central heating system. For indirect heating systems only. Tappings are the width of the rail and 33 or 53mm off the wall.



Pictured 89.0960 Matt Anthracite with 89.0182 Towel Hangers x2



### Charlton Cover Cap Sets - Chrome

Description	Code	£ Ex VAT	£ Inc VAT
Cover Cap Set 280mm	89.0165	18.00	21.60
Cover Cap Set 375mm	89.0166	21.00	25.20
Cover Cap Set 470mm	89.0167	23.00	27.60
Cover Cap Set 565mm	89.0837	28.00	33.60

Cover cap sets only include cover caps for the top of the radiator.

For element types see pages 288-300.

Element can only be installed vertically on the right-hand side on the bottom header. Radiators that are electric only are restricted to the heat output of the elements. Element size can be increased to full capacity of rail if using element type F or G. For dual fuel installations, element must be installed on flow side.

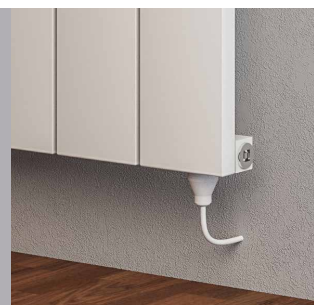

### Round Vent Caps

Page 313



# Aluminium Range

## CHARLTON HORIZONTAL



Pictured 89.0751 Matt Anthracite

A contemporary versatile radiator style, that come in three finishes, with an optional extra of stylish towel hangers.

### Charlton Horizontal Aluminium Radiators - Matt White

Size H x W	Watts	BTU	Element Output	Element Type	Code	£ Ex VAT	£ Inc VAT
600 x 470mm	503	1717	300W	A, A+, C, H	89.0743	252.00	<b>302.40</b>
600 x 660mm	697	2379	450W	A, A+, C, H	89.0744	332.00	<b>398.40</b>
600 x 850mm	890	3037	600W	A, A+, C, H	89.0745	415.00	<b>498.00</b>
600 x 1040mm	1081	3689	750W	A, A+, C, H	89.0746	493.00	<b>591.60</b>
600 x 1230mm	1271	4337	900W	A, A+, C, H	89.0747	580.00	<b>696.00</b>
600 x 1420mm	1460	4982	900W	A, A+, C, H	89.0929	679.00	<b>814.80</b>

### Charlton Horizontal Aluminium Radiators - Matt Anthracite

Size H x W	Watts	BTU	Element Output	Element Type	Code	£ Ex VAT	£ Inc VAT
600 x 470mm	503	1717	300W	A, A+, C, H	89.0748	252.00	<b>302.40</b>
600 x 660mm	697	2379	450W	A, A+, C, H	89.0749	332.00	<b>398.40</b>
600 x 850mm	890	3037	600W	A, A+, C, H	89.0750	415.00	<b>498.00</b>
600 x 1040mm	1081	3689	750W	A, A+, C, H	89.0751	493.00	<b>591.60</b>
600 x 1230mm	1271	4337	900W	A, A+, C, H	89.0752	580.00	<b>696.00</b>
600 x 1420mm	1460	4982	900W	A, A+, C, H	89.0962	679.00	<b>814.80</b>

### Charlton Horizontal Aluminium Radiators - Matt Black

Size H x W	Watts	BTU	Element Output	Element Type	Code	£ Ex VAT	£ Inc VAT
600 x 470mm	503	1717	300W	A, A+, C, H	89.0753	252.00	<b>302.40</b>
600 x 660mm	697	2379	450W	A, A+, C, H	89.0754	332.00	<b>398.40</b>
600 x 850mm	890	3037	600W	A, A+, C, H	89.0755	415.00	<b>498.00</b>
600 x 1040mm	1081	3689	750W	A, A+, C, H	89.0756	493.00	<b>591.60</b>
600 x 1230mm	1271	4337	900W	A, A+, C, H	89.0757	580.00	<b>696.00</b>
600 x 1420mm	1460	4982	900W	A, A+, C, H	89.0983	679.00	<b>814.80</b>

Warranty

**5**  
Year

Heating

All Electric

Dual-Fuel

For element types see pages 288-300.

Element can only be installed horizontally on the bottom header. Radiators that are electric only are restricted to the heat output of the elements (Type C&H up to 900 watts).



### FEATURES

- Excellent heat conductivity and lightweight
  - Only requires a low water volume
  - Heats up very quickly
  - Radiators come with cover caps on top and bottom, same as radiator colour.
  - Can be single, dual fuel or all electric
  - Tested to BS EN 442 standards
  - 5 Year Manufacturer's Warranty\*
- \* With conditions

Technical Tables & Drawings  
Page 362-363



### TECHNICAL INFORMATION

All measurements in Height by Width. Heat output based on  $\Delta T60^{\circ}C$ . For matching valves see pages 301-309. Corrosion inhibitor must be added to the heating system and maintained. Flow diverter must only be fitted when radiator installed on central heating system. For indirect heating systems only. Tappings are the width of the rail and 33 or 53mm off the wall.



### Charlton Cover Cap Sets - Chrome

Description	Code	£ Ex VAT	£ Inc VAT
Cover Cap Set 470mm	89.0167	23.00	<b>27.60</b>
Cover Cap Set 660mm	89.0838	33.00	<b>39.60</b>
Cover Cap Set 850mm	89.0839	40.00	<b>48.00</b>
Cover Cap Set 1040mm	89.0840	47.00	<b>56.40</b>
Cover Cap Set 1230mm	89.0841	56.00	<b>67.20</b>
Cover Cap Set 1420mm	89.1404	61.00	<b>73.20</b>

Cover cap sets only include cover caps for the top of the radiator.

Round Vent Caps  
Page 313



# Aluminium Range

## CHARLTON STANDARD TOWEL HANGERS



Towel Hanger - Matt White			
Size	Code	£ Ex VAT	£ Inc VAT
280mm	89.0177	62.00	<b>74.40</b>
375mm	89.0178	66.00	<b>79.20</b>
470mm	89.0179	74.00	<b>88.80</b>
565mm	86.0333	78.00	<b>93.60</b>



Towel Hanger - Matt Anthracite			
Size	Code	£ Ex VAT	£ Inc VAT
280mm	89.0180	62.00	<b>74.40</b>
375mm	89.0181	66.00	<b>79.20</b>
470mm	89.0182	74.00	<b>88.80</b>
565mm	86.0334	78.00	<b>93.60</b>

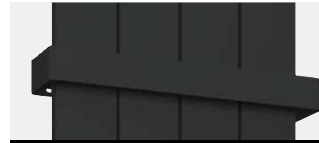

Towel Hanger - Matt Black			
Size	Code	£ Ex VAT	£ Inc VAT
280mm	89.0183	62.00	<b>74.40</b>
375mm	89.0184	66.00	<b>79.20</b>
470mm	89.0185	74.00	<b>88.80</b>
565mm	86.0335	78.00	<b>93.60</b>



Towel Hanger - Chrome			
Size	Code	£ Ex VAT	£ Inc VAT
280mm	89.0134	53.00	<b>63.60</b>
375mm	89.0135	56.00	<b>67.20</b>
470mm	89.0136	65.00	<b>78.00</b>
565mm	86.0336	72.00	<b>86.40</b>

### TECHNICAL INFORMATION

Material: **Steel (Premium: Stainless Steel - Grade 304)**

1200mm radiators come with 2 pre-drilled towel hanger locations with a maximum of 2 towel hangers and 1800mm height radiators come with 3 pre-drilled towel hanger locations with a maximum of 3 towel hangers - all widths; 280, 375, 470 and 565mm. 600mm height radiators come with 1 pre-drilled towel hanger location, with a maximum of 1 towel hanger - 280mm width. The Charlton Standard Towel Hangers will add approx 8mm width on each side once fitted to the radiator.

600mm height x 470mm width radiator can have one towel hanger.

**Can be fitted after installation only on high adjustment bracket fitting.**

**Due in November 2023**



Towel Hanger - Brushed Brass			
Size	Code	£ Ex VAT	£ Inc VAT
280mm	41.0616	56.00	<b>67.20</b>
375mm	41.0617	63.00	<b>75.60</b>
470mm	41.0618	72.00	<b>86.40</b>
565mm	41.0619	76.00	<b>91.20</b>



Towel Hanger - Mirror Polished Premium			
Size	Code	£ Ex VAT	£ Inc VAT
280mm	86.0198	73.00	<b>87.60</b>
375mm	86.0199	80.00	<b>96.00</b>
470mm	86.0200	87.00	<b>104.40</b>
565mm	86.0337	93.00	<b>111.60</b>

## CHARLTON FLAT STYLE TOWEL HANGERS

### SINGLE FLAT STYLE



Towel Hanger - Matt White			
Size	Code	£ Ex VAT	£ Inc VAT
280mm	89.0283	72.00	<b>86.40</b>
375mm	89.0284	79.00	<b>94.80</b>
470mm	89.0285	89.00	<b>106.80</b>
565mm	91.0163	95.00	<b>114.00</b>
660mm	89.0286	100.00	<b>120.00</b>
850mm	89.0287	112.00	<b>134.40</b>

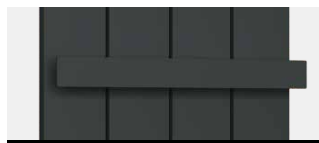

Towel Hanger - Matt Anthracite			
Size	Code	£ Ex VAT	£ Inc VAT
280mm	89.0288	72.00	<b>86.40</b>
375mm	89.0289	79.00	<b>94.80</b>
470mm	89.0290	89.00	<b>106.80</b>
565mm	91.0164	95.00	<b>114.00</b>
660mm	89.0291	100.00	<b>120.00</b>
850mm	89.0292	112.00	<b>134.40</b>

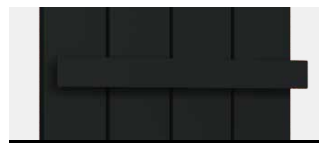

Towel Hanger - Matt Black			
Size	Code	£ Ex VAT	£ Inc VAT
280mm	89.0293	72.00	<b>86.40</b>
375mm	89.0294	79.00	<b>94.80</b>
470mm	89.0295	89.00	<b>106.80</b>
565mm	91.0165	95.00	<b>114.00</b>
660mm	89.0296	100.00	<b>120.00</b>
850mm	89.0297	112.00	<b>134.40</b>



Towel Hanger - Chrome			
Size	Code	£ Ex VAT	£ Inc VAT
280mm	91.0094	98.00	<b>117.60</b>
375mm	91.0095	100.00	<b>120.00</b>
470mm	91.0096	102.00	<b>122.40</b>
565mm	91.0166	103.00	<b>123.60</b>
660mm	91.0097	108.00	<b>129.60</b>
850mm	91.0098	115.00	<b>138.00</b>

### DOUBLE FLAT STYLE



Towel Hanger - Matt White			
Size	Code	£ Ex VAT	£ Inc VAT
280mm	89.0369	88.00	<b>105.60</b>
375mm	89.0370	92.00	<b>110.40</b>
470mm	89.0371	103.00	<b>123.60</b>
565mm	91.0167	114.00	<b>136.80</b>
660mm	89.0372	121.00	<b>145.20</b>
850mm	89.0373	135.00	<b>162.00</b>

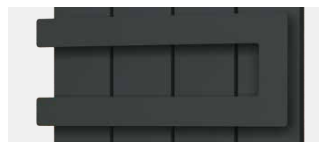

Towel Hanger - Matt Anthracite			
Size	Code	£ Ex VAT	£ Inc VAT
280mm	89.0374	88.00	<b>105.60</b>
375mm	89.0375	92.00	<b>110.40</b>
470mm	89.0376	103.00	<b>123.60</b>
565mm	91.0168	114.00	<b>136.80</b>
660mm	89.0377	121.00	<b>145.20</b>
850mm	89.0378	135.00	<b>162.00</b>

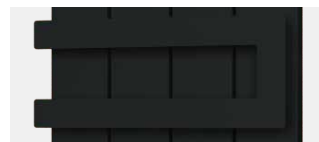

Towel Hanger - Matt Black			
Size	Code	£ Ex VAT	£ Inc VAT
280mm	89.0379	88.00	<b>105.60</b>
375mm	89.0380	92.00	<b>110.40</b>
470mm	89.0381	103.00	<b>123.60</b>
565mm	91.0169	114.00	<b>136.80</b>
660mm	89.0382	121.00	<b>145.20</b>
850mm	89.0383	135.00	<b>162.00</b>



Towel Hanger - Chrome			
Size	Code	£ Ex VAT	£ Inc VAT
280mm	91.0114	124.00	<b>148.80</b>
375mm	91.0115	130.00	<b>156.00</b>
470mm	91.0116	132.00	<b>158.40</b>
565mm	91.0170	138.00	<b>165.60</b>
660mm	91.0117	142.00	<b>170.40</b>
850mm	91.0118	154.00	<b>184.80</b>

### TECHNICAL INFORMATION

Material: **Steel**

#### Vertical and Horizontal Radiators:

Flat & Double Flat Style Hangers are compatible with both Vertical and Horizontal radiators. (Depending on the radiators and hangers width)

**Must be fitted before installation!**

Hanger Fitting Widths  
96/191/286/381/476/666mm



Hanger Fitting Widths  
96/191/286/381/476/666mm



# Aluminium Range

## WITHINGTON VERTICAL





Pictured 89.0142 Matt Anthracite with 86.0079 Towel Hangers x3 & 89.0170 Cover Caps x2



Pictured 89.0139 Matt White with 101.0058 Towel Hanger

An elegant aluminium radiator with clean lines which will be the centre of attention in any room. Towel hangers and chrome caps are available as an additional extras.

<p>Warranty</p> <p><b>5</b></p> <p>Year</p>	<p>Heating</p> 	<p>All Electric</p> 	<p>Dual-Fuel</p> 
---	--	---	--

### FEATURES

- Excellent heat conductivity and lightweight
- Heats up very quickly
- Only requires a low water volume
- Radiators come with cover caps on top and bottom, same as radiator colour. Matt Cobalt Blue radiators come with Chrome Cover Caps
- Can be single, dual fuel or all electric
- Tested to BS EN 442 standards
- 5 Year Manufacturer's Warranty\*
- \* With conditions

### Technical Tables & Drawings

Page 364-365





# Aluminium Range

## WITHINGTON VERTICAL

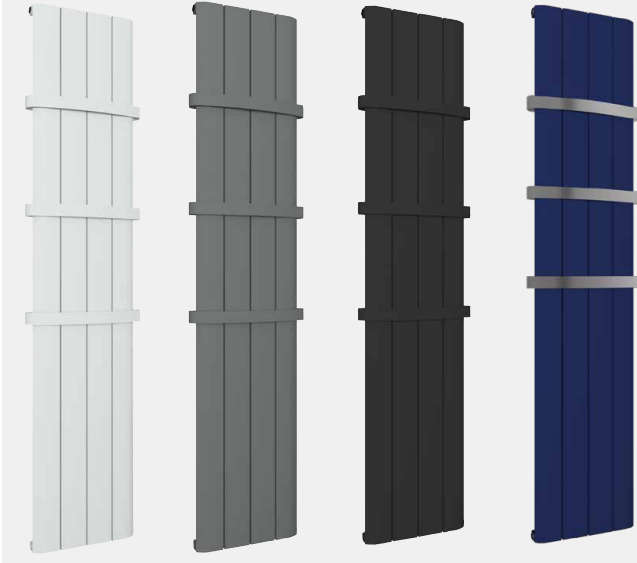

Matt White

Matt Anthracite

Matt Black

Matt Cobalt Blue

### Withington Aluminium Radiators - Matt White

Size H x W	Watts	BTU	Element Output	Element Type	Code	£ Ex VAT	£ Inc VAT
600 x 280mm	305	1041	150W	A, A+, F, G	89.0782	182.00	<b>218.40</b>
1200 x 280mm	559	1908	300W	A, A+, F, G	89.0930	251.00	<b>301.20</b>
1200 x 375mm	742	2532	300W	A, A+, F, G	89.0931	323.00	<b>387.60</b>
1200 x 470mm	922	3146	450W	A, A+, F, G	89.0932	395.00	<b>474.00</b>
1200 x 565mm	1101	3757	600W	A, A+, F, G	89.0933	472.00	<b>566.40</b>
1800 x 280mm	812	2771	450W	A, A+, F, G	89.0137	307.00	<b>368.40</b>
1800 x 375mm	1076	3672	600W	A, A+, F, G	89.0139	397.00	<b>476.40</b>
1800 x 470mm	1338	4566	750W	A, A+, F, G	89.0141	479.00	<b>574.80</b>
1800 x 565mm	1598	5453	1000W	A, A+, F, G	89.0783	595.00	<b>714.00</b>

### Withington Aluminium Radiators - Matt Anthracite

Size H x W	Watts	BTU	Element Output	Element Type	Code	£ Ex VAT	£ Inc VAT
600 x 280mm	305	1041	150W	A, A+, F, G	89.0784	182.00	<b>218.40</b>
1200 x 280mm	559	1908	300W	A, A+, F, G	89.0963	251.00	<b>301.20</b>
1200 x 375mm	742	2532	300W	A, A+, F, G	89.0964	323.00	<b>387.60</b>
1200 x 470mm	922	3146	450W	A, A+, F, G	89.0965	395.00	<b>474.00</b>
1200 x 565mm	1101	3757	600W	A, A+, F, G	89.0966	472.00	<b>566.40</b>
1800 x 280mm	812	2771	450W	A, A+, F, G	89.0138	307.00	<b>368.40</b>
1800 x 375mm	1076	3672	600W	A, A+, F, G	89.0140	397.00	<b>476.40</b>
1800 x 470mm	1338	4566	750W	A, A+, F, G	89.0142	479.00	<b>574.80</b>
1800 x 565mm	1598	5453	1000W	A, A+, F, G	89.0785	595.00	<b>714.00</b>

### Withington Aluminium Radiators - Matt Black

Size H x W	Watts	BTU	Element Output	Element Type	Code	£ Ex VAT	£ Inc VAT
600 x 280mm	305	1041	150W	A, A+, F, G	89.0786	182.00	<b>218.40</b>
1200 x 280mm	559	1908	300W	A, A+, F, G	89.0984	251.00	<b>301.20</b>
1200 x 375mm	742	2532	300W	A, A+, F, G	89.0985	323.00	<b>387.60</b>
1200 x 470mm	922	3146	450W	A, A+, F, G	89.0986	395.00	<b>474.00</b>
1200 x 565mm	1101	3757	600W	A, A+, F, G	89.0987	472.00	<b>566.40</b>
1800 x 280mm	812	2771	450W	A, A+, F, G	89.0787	307.00	<b>368.40</b>
1800 x 375mm	1076	3672	600W	A, A+, F, G	89.0788	397.00	<b>476.40</b>
1800 x 470mm	1338	4566	750W	A, A+, F, G	89.0789	479.00	<b>574.80</b>
1800 x 565mm	1598	5453	1000W	A, A+, F, G	89.0790	595.00	<b>714.00</b>

### Withington Aluminium Radiators - Matt Cobalt Blue

Size H x W	Watts	BTU	Element Output	Element Type	Code	£ Ex VAT	£ Inc VAT
1800 x 280mm	812	2771	450W	A, A+, F, G	89.1608	307.00	<b>368.40</b>
1800 x 375mm	1076	3672	600W	A, A+, F, G	89.1609	397.00	<b>476.40</b>
1800 x 470mm	1338	4566	750W	A, A+, F, G	89.1610	479.00	<b>574.80</b>

Prices include radiator and wall fixing sets, valves and accessories extra.



Pictured 89.0987 Matt Black

### TECHNICAL INFORMATION

All measurements in Height by Width. Heat output based on  $\Delta T60^{\circ}\text{C}$ . For matching valves see pages 301-309. Corrosion inhibitor must be added to the heating system and maintained. Flow diverter must only be fitted when radiator installed on central heating system. For indirect heating systems only. Tappings are the width of the rail and 33 or 53mm off the wall.



### Withington Cover Cap Sets - Chrome

Description	Code	£ Ex VAT	£ Inc VAT
Cover Cap Set 280mm	89.0168	18.00	<b>21.60</b>
Cover Cap Set 375mm	89.0169	21.00	<b>25.20</b>
Cover Cap Set 470mm	89.0170	23.00	<b>27.60</b>
Cover Cap Set 565mm	89.0842	28.00	<b>33.60</b>

Cover Caps Chrome: The cover cap set only includes cover caps for the top or the bottom of the radiator.

### Round Vent Caps

Page 313



For element types see pages 288-300.

Element can only be installed vertically on the right-hand side on the bottom header. Radiators that are electric only are restricted to the heat output of the elements. Element size can be increased to full capacity of rail if using element type F or G. For dual fuel installations, element must be installed on flow side.

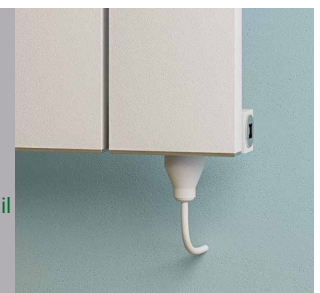

# Aluminium Range

## WITHINGTON HORIZONTAL

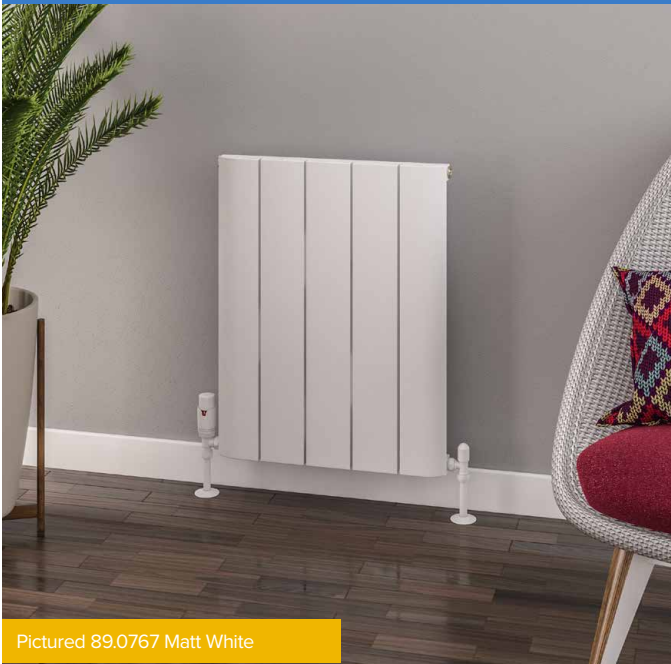

Pictured 89.0767 Matt White



Pictured 89.1612 Matt Cobalt Blue

A contemporary versatile radiator style, that come in four finishes, with an optional extra of stylish towel hangers.

### Withington Horizontal Aluminium Radiators - Matt White

Size H x W	Watts	BTU	Element Output	Element Type	Code	£ Ex VAT	£ Inc VAT
600 x 470mm	502	1713	300W	A, A+, C, H	89.0767	252.00	302.40
600 x 660mm	697	2379	450W	A, A+, C, H	89.0768	332.00	398.40
600 x 850mm	889	3034	600W	A, A+, C, H	89.0769	415.00	498.00
600 x 1040mm	1080	3685	750W	A, A+, C, H	89.0770	493.00	591.60
600 x 1230mm	1270	4334	900W	A, A+, C, H	89.0771	580.00	696.00
600 x 1420mm	1459	4979	900W	A, A+, C, H	89.0934	679.00	814.80

### Withington Horizontal Aluminium Radiators - Matt Anthracite

Size H x W	Watts	BTU	Element Output	Element Type	Code	£ Ex VAT	£ Inc VAT
600 x 470mm	502	1713	300W	A, A+, C, H	89.0772	252.00	302.40
600 x 660mm	697	2379	450W	A, A+, C, H	89.0773	332.00	398.40
600 x 850mm	889	3034	600W	A, A+, C, H	89.0774	415.00	498.00
600 x 1040mm	1080	3685	750W	A, A+, C, H	89.0775	493.00	591.60
600 x 1230mm	1270	4334	900W	A, A+, C, H	89.0776	580.00	696.00
600 x 1420mm	1459	4979	900W	A, A+, C, H	89.0967	679.00	814.80

### Withington Horizontal Aluminium Radiators - Matt Black

Size H x W	Watts	BTU	Element Output	Element Type	Code	£ Ex VAT	£ Inc VAT
600 x 470mm	502	1713	300W	A, A+, C, H	89.0777	252.00	302.40
600 x 660mm	697	2379	450W	A, A+, C, H	89.0778	332.00	398.40
600 x 850mm	889	3034	600W	A, A+, C, H	89.0779	415.00	498.00
600 x 1040mm	1080	3685	750W	A, A+, C, H	89.0780	493.00	591.60
600 x 1230mm	1270	4334	900W	A, A+, C, H	89.0781	580.00	696.00
600 x 1420mm	1459	4979	900W	A, A+, C, H	89.0988	679.00	814.80

### Withington Horizontal Aluminium Radiators - Matt Cobalt Blue

Size H x W	Watts	BTU	Element Output	Element Type	Code	£ Ex VAT	£ Inc VAT
600 x 470mm	502	1713	300W	A, A+, C, H	89.1611	252.00	302.40
600 x 660mm	697	2379	450W	A, A+, C, H	89.1612	332.00	398.40
600 x 850mm	889	3034	600W	A, A+, C, H	89.1613	415.00	498.00
600 x 1040mm	1080	3685	750W	A, A+, C, H	89.1614	493.00	591.60
600 x 1230mm	1270	4334	900W	A, A+, C, H	89.1615	580.00	696.00

Prices include radiator and wall fixing sets, valves and accessories extra.

For element types see pages 288-300.

Element can only be installed horizontally on the bottom header. Radiators that are electric only are restricted to the heat output of the elements (Type C&H up to 900 watts).



5
Year

Heating

All Electric

Dual-Fuel

### FEATURES

- Excellent heat conductivity and lightweight
  - Heats up very quickly
  - Only requires a low water volume
  - Radiators come with cover caps on top and bottom, same as radiator colour. Matt Cobalt Blue radiators come with Chrome Cover Caps
  - Can be single, dual fuel or all electric
  - Tested to BS EN 442 standards
  - 5 Year Manufacturer's Warranty\*
- \* With conditions

### Technical Tables & Drawings

Page 364-365



### TECHNICAL INFORMATION

All measurements in Height by Width. Heat output based on  $\Delta T60^{\circ}\text{C}$ . For matching valves see pages 301-309. Corrosion inhibitor must be added to the heating system and maintained. Flow diverter must only be fitted when radiator installed on central heating system. For indirect heating systems only. Tappings are the width of the rail and 33 or 53mm off the wall.



### Withington Cover Cap Sets - Chrome

Description	Code	£ Ex VAT	£ Inc VAT
Cover Cap Set 470mm	89.0170	23.00	27.60
Cover Cap Set 660mm	89.0843	33.00	39.60
Cover Cap Set 850mm	89.0844	40.00	48.00
Cover Cap Set 1040mm	89.0845	47.00	56.40
Cover Cap Set 1230mm	89.0846	56.00	67.20
Cover Cap Set 1420mm	89.1405	61.00	73.20

Cover Caps Chrome: The cover cap set only includes cover caps for the top or the bottom of the radiator.

### Round Vent Caps

Page 313



# Aluminium Range

## WITHINGTON STANDARD TOWEL HANGERS



Towel Hanger - Matt White			
Size	Code	£ Ex VAT	£ Inc VAT
280mm	89.0186	62.00	<b>74.40</b>
375mm	89.0187	66.00	<b>79.20</b>
470mm	89.0188	74.00	<b>88.80</b>
565mm	86.0338	78.00	<b>93.60</b>

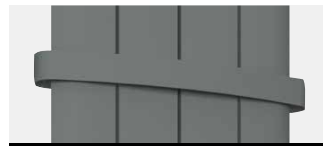

Towel Hanger - Matt Anthracite			
Size	Code	£ Ex VAT	£ Inc VAT
280mm	89.0189	62.00	<b>74.40</b>
375mm	89.0190	66.00	<b>79.20</b>
470mm	89.0191	74.00	<b>88.80</b>
565mm	86.0339	78.00	<b>93.60</b>

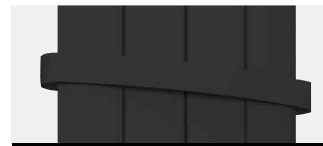

Towel Hanger - Matt Black			
Size	Code	£ Ex VAT	£ Inc VAT
280mm	89.0192	62.00	<b>74.40</b>
375mm	89.0193	66.00	<b>79.20</b>
470mm	89.0194	74.00	<b>88.80</b>
565mm	86.0340	78.00	<b>93.60</b>



Towel Hanger - Chrome			
Size	Code	£ Ex VAT	£ Inc VAT
280mm	86.0077	53.00	<b>63.60</b>
375mm	86.0078	62.00	<b>74.40</b>
470mm	86.0079	69.00	<b>82.80</b>
565mm	86.0341	72.00	<b>86.40</b>



Towel Hanger - Mirror Polished Premium			
Size	Code	£ Ex VAT	£ Inc VAT
280mm	86.0201	73.00	<b>87.60</b>
375mm	86.0202	80.00	<b>96.00</b>
470mm	86.0203	87.00	<b>104.40</b>
565mm	86.0342	93.00	<b>111.60</b>



Towel Hanger - Brushed Brass			
Size	Code	£ Ex VAT	£ Inc VAT
280mm	41.0612	59.00	<b>70.80</b>
375mm	41.0613	68.00	<b>81.60</b>
470mm	41.0614	77.00	<b>92.40</b>
565mm	41.0615	81.00	<b>97.20</b>

Due in November 2023

### TECHNICAL INFORMATION

Material: Steel (Premium: Stainless Steel - Grade 304)

1200mm radiators come with 2 pre-drilled towel hanger locations with a maximum of 2 towel hangers and 1800mm height radiators come with 3 pre-drilled towel hanger locations with a maximum of 3 towel hangers - all widths; 280, 375, 470 and 565mm. 600mm height radiators come with 1 pre-drilled towel hanger location, with a maximum of 1 towel hanger - 280mm width. The Withington Standard Towel Hangers will add approx 8mm width on each side once fitted to the radiator.

600mm height x 470mm width radiator can have one towel hanger.

Can be fitted after installation only on high adjustment bracket fitting.

## WITHINGTON FLAT STYLE TOWEL HANGERS

### SINGLE FLAT STYLE



Towel Hanger - Matt White			
Size	Code	£ Ex VAT	£ Inc VAT
280mm	89.0283	72.00	<b>86.40</b>
375mm	89.0284	79.00	<b>94.80</b>
470mm	89.0285	89.00	<b>106.80</b>
565mm	91.0163	95.00	<b>114.00</b>
660mm	89.0286	100.00	<b>120.00</b>
850mm	89.0287	112.00	<b>134.40</b>

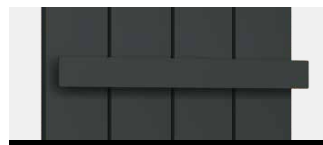

Towel Hanger - Matt Anthracite			
Size	Code	£ Ex VAT	£ Inc VAT
280mm	89.0288	72.00	<b>86.40</b>
375mm	89.0289	79.00	<b>94.80</b>
470mm	89.0290	89.00	<b>106.80</b>
565mm	91.0164	95.00	<b>114.00</b>
660mm	89.0291	100.00	<b>120.00</b>
850mm	89.0292	112.00	<b>134.40</b>

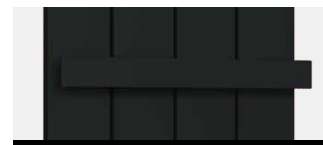

Towel Hanger - Matt Black			
Size	Code	£ Ex VAT	£ Inc VAT
280mm	89.0293	72.00	<b>86.40</b>
375mm	89.0294	79.00	<b>94.80</b>
470mm	89.0295	89.00	<b>106.80</b>
565mm	91.0165	95.00	<b>114.00</b>
660mm	89.0296	100.00	<b>120.00</b>
850mm	89.0297	112.00	<b>134.40</b>



Towel Hanger - Chrome			
Size	Code	£ Ex VAT	£ Inc VAT
280mm	91.0094	98.00	<b>117.60</b>
375mm	91.0095	100.00	<b>120.00</b>
470mm	91.0096	102.00	<b>122.40</b>
565mm	91.0166	103.00	<b>123.60</b>
660mm	91.0097	108.00	<b>129.60</b>
850mm	91.0098	115.00	<b>138.00</b>



Towel Hanger - Matt White			
Size	Code	£ Ex VAT	£ Inc VAT
280mm	89.0369	88.00	<b>105.60</b>
375mm	89.0370	92.00	<b>110.40</b>
470mm	89.0371	103.00	<b>123.60</b>
565mm	91.0167	114.00	<b>136.80</b>
660mm	89.0372	121.00	<b>145.20</b>
850mm	89.0373	135.00	<b>162.00</b>

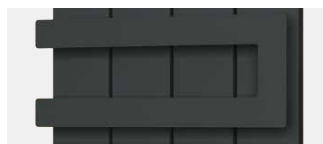

Towel Hanger - Matt Anthracite			
Size	Code	£ Ex VAT	£ Inc VAT
280mm	89.0374	88.00	<b>105.60</b>
375mm	89.0375	92.00	<b>110.40</b>
470mm	89.0376	103.00	<b>123.60</b>
565mm	91.0168	114.00	<b>136.80</b>
660mm	89.0377	121.00	<b>145.20</b>
850mm	89.0378	135.00	<b>162.00</b>

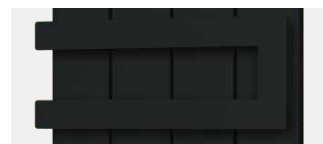

Towel Hanger - Matt Black			
Size	Code	£ Ex VAT	£ Inc VAT
280mm	89.0379	88.00	<b>105.60</b>
375mm	89.0380	92.00	<b>110.40</b>
470mm	89.0381	103.00	<b>123.60</b>
565mm	91.0169	114.00	<b>136.80</b>
660mm	89.0382	121.00	<b>145.20</b>
850mm	89.0383	135.00	<b>162.00</b>



Towel Hanger - Chrome			
Size	Code	£ Ex VAT	£ Inc VAT
280mm	91.0114	124.00	<b>148.80</b>
375mm	91.0115	130.00	<b>156.00</b>
470mm	91.0116	132.00	<b>158.40</b>
565mm	91.0170	138.00	<b>165.60</b>
660mm	91.0117	142.00	<b>170.40</b>
850mm	91.0118	154.00	<b>184.80</b>

### TECHNICAL INFORMATION

Material: Steel

#### Vertical and Horizontal Radiators:

Flat & Double Flat Style Hangers are compatible with both Vertical and Horizontal radiators. (Depending on the radiators and hangers width)

**Must be fitted before installation!**

Hanger Fitting Widths  
96/191/286/381/476/666mm



Hanger Fitting Widths  
96/191/286/381/476/666mm



# Aluminium Range

## MALMESBURY VERTICAL



An aluminium radiator range available in both Vertical and Horizontal designs in Matt White, Matt Anthracite, Matt Cappuccino or Matt Grey finishes. Optional extras include chrome cover caps and towel hangers.

### FEATURES

- Excellent heat conductivity and lightweight
- Only requires a low water volume
- Heats up very quickly
- Radiators come with cover caps on top and bottom, same as radiator colour
- Can be single, dual fuel or all electric
- Tested to BS EN 442 standards
- 5 Year Manufacturer's Warranty\*
- \* With conditions



Technical Tables  
& Drawings  
Page 364-365



Warranty  
**5**  
Year

Heating

All Electric

Dual-Fuel

Pictured 89.0148 Matt White with 89.0883L Multi-Purpose Towel Hanger (See page 726)

Pictured 89.0279 Matt Grey with 89.0301 Towel Hangers

# Aluminium Range

## MALMESBURY VERTICAL

### Malmesbury Vertical Aluminium Radiators - Matt White

Size H x W	Watts	BTU	Element Output	Element Type	Code	£ Ex VAT	£ Inc VAT
1200 x 185mm	375	1280	150W	A, A+, F, G	89.0935	187.00	224.40
1200 x 280mm	554	1891	300W	A, A+, F, G	89.0936	266.00	319.20
1200 x 375mm	730	2491	300W	A, A+, F, G	89.0937	343.00	411.60
1200 x 470mm	903	3082	450W	A, A+, F, G	89.0938	418.00	501.60
1200 x 565mm	1074	3665	600W	A, A+, F, G	89.0939	500.00	600.00
1800 x 185mm	544	1857	300W	A, A+, F, G	89.0277	231.00	277.20
1800 x 280mm	804	2744	450W	A, A+, F, G	89.0146	327.00	392.40
1800 x 375mm	1060	3617	600W	A, A+, F, G	89.0148	416.00	499.20
1800 x 470mm	1311	4474	750W	A, A+, F, G	89.0150	509.00	610.80
1800 x 565mm	1560	5323	1000W	A, A+, F, G	89.0739	613.00	735.60

### Malmesbury Vertical Aluminium Radiators - Matt Grey

Size H x W	Watts	BTU	Element Output	Element Type	Code	£ Ex VAT	£ Inc VAT
1200 x 185mm	375	1280	150W	A, A+, F, G	89.0946	187.00	224.40
1200 x 280mm	554	1891	300W	A, A+, F, G	89.0947	266.00	319.20
1200 x 375mm	730	2491	300W	A, A+, F, G	89.0948	343.00	411.60
1200 x 470mm	903	3082	450W	A, A+, F, G	89.0949	418.00	501.60
1200 x 565mm	1074	3665	600W	A, A+, F, G	89.0950	500.00	600.00
1800 x 185mm	544	1857	300W	A, A+, F, G	89.0279	231.00	277.20
1800 x 280mm	804	2744	450W	A, A+, F, G	89.0280	327.00	392.40
1800 x 375mm	1060	3617	600W	A, A+, F, G	89.0281	416.00	499.20
1800 x 470mm	1311	4474	750W	A, A+, F, G	89.0282	509.00	610.80
1800 x 565mm	1560	5323	1000W	A, A+, F, G	89.0740	613.00	735.60

### Malmesbury Vertical Aluminium Radiators - Matt Anthracite

Size H x W	Watts	BTU	Element Output	Element Type	Code	£ Ex VAT	£ Inc VAT
1200 x 185mm	375	1280	150W	A, A+, F, G	89.0968	187.00	224.40
1200 x 280mm	554	1891	300W	A, A+, F, G	89.0969	266.00	319.20
1200 x 375mm	730	2491	300W	A, A+, F, G	89.0970	343.00	411.60
1200 x 470mm	903	3082	450W	A, A+, F, G	89.0971	418.00	501.60
1200 x 565mm	1074	3665	600W	A, A+, F, G	89.0972	500.00	600.00
1800 x 185mm	544	1857	300W	A, A+, F, G	89.0278	231.00	277.20
1800 x 280mm	804	2744	450W	A, A+, F, G	89.0147	327.00	392.40
1800 x 375mm	1060	3617	600W	A, A+, F, G	89.0149	416.00	499.20
1800 x 470mm	1311	4474	750W	A, A+, F, G	89.0151	509.00	610.80
1800 x 565mm	1560	5323	1000W	A, A+, F, G	89.0742	613.00	735.60

### Malmesbury Vertical Aluminium Radiators - Matt Cappuccino

Size H x W	Watts	BTU	Element Output	Element Type	Code	£ Ex VAT	£ Inc VAT
1200 x 185mm	375	1280	150W	A, A+, F, G	89.0952	187.00	224.40
1200 x 280mm	554	1891	300W	A, A+, F, G	89.0953	266.00	319.20
1200 x 375mm	730	2491	300W	A, A+, F, G	89.0954	343.00	411.60
1200 x 470mm	903	3082	450W	A, A+, F, G	89.0955	418.00	501.60
1200 x 565mm	1074	3665	600W	A, A+, F, G	89.0956	500.00	600.00
1800 x 185mm	544	1857	300W	A, A+, F, G	89.0477	257.00	308.40
1800 x 280mm	804	2744	450W	A, A+, F, G	89.0478	363.00	435.60
1800 x 375mm	1060	3617	600W	A, A+, F, G	89.0479	467.00	560.40
1800 x 470mm	1311	4474	750W	A, A+, F, G	89.0480	571.00	685.20
1800 x 565mm	1560	5323	1000W	A, A+, F, G	89.0741	675.00	810.00

Prices include radiator and wall fixing sets, valves and accessories extra.

### TECHNICAL INFORMATION

All measurements in Height by Width. Heat output based on ▲T60°C. For matching valves see pages 301-309. Corrosion inhibitor must be added to the heating system and maintained. Flow diverter must only be fitted when radiator installed on central heating system. For indirect heating systems only. Tappings are the width of the rail and 33 or 53mm off the wall.

### Round Vent Caps

Page 313



For all Malmesbury Matt White, Matt Anthracite, Matt Cappuccino, Matt Grey & Chrome Towel Hangers, please refer to page 205.



For element types see pages 288-300.

Element can only be installed vertically on the right-hand side on the bottom header. Radiators that are electric only are restricted to the heat output of the elements. Element size can be increased to full capacity of rail if using element type F or G. For dual fuel installations, element must be installed on flow side.



### Malmesbury Cover Caps - Chrome

Description	Code	£ Ex VAT	£ Inc VAT
Cover Cap Set 185mm	89.0422	19.00	22.80
Cover Cap Set 280mm	89.0171	19.00	22.80
Cover Cap Set 375mm	89.0172	21.00	25.20
Cover Cap Set 470mm	89.0173	24.00	28.80
Cover Cap Set 565mm	89.0174	28.00	33.60

Cover Caps Chrome The cover cap set only includes cover caps for the top or the bottom of the radiator.

# Aluminium Range

## MALMESBURY HORIZONTAL

Warranty

5

Year

Heating

All Electric

Dual-Fuel



Pictured 89.0425 Matt White

An aluminium radiator range available in both vertical and horizontal designs in matt white, matt anthracite, matt cappuccino or matt grey finishes. Optional extras include chrome cover caps and towel hangers.

### 500mm Height

#### Malmesbury Horizontal Aluminium Radiators - Matt White

Size H x W	Watts	BTU	Element Output	Element Type	Code	£ Ex VAT	£ Inc VAT
500 x 375mm	340	1161	150W	A, A+, C, H	89.0432	195.00	234.00
500 x 470mm	421	1437	150W	A, A+, C, H	89.0433	242.00	290.40
500 x 565mm	500	1706	300W	A, A+, C, H	89.0434	285.00	342.00

#### Malmesbury Horizontal Aluminium Radiators - Matt Grey

Size H x W	Watts	BTU	Element Output	Element Type	Code	£ Ex VAT	£ Inc VAT
500 x 375mm	340	1161	150W	A, A+, C, H	89.0435	195.00	234.00
500 x 470mm	421	1437	150W	A, A+, C, H	89.0436	242.00	290.40
500 x 565mm	500	1706	300W	A, A+, C, H	89.0437	285.00	342.00

#### Malmesbury Horizontal Aluminium Radiators - Matt Anthracite

Size H x W	Watts	BTU	Element Output	Element Type	Code	£ Ex VAT	£ Inc VAT
500 x 375mm	340	1161	150W	A, A+, C, H	89.0438	195.00	234.00
500 x 470mm	421	1437	150W	A, A+, C, H	89.0439	242.00	290.40
500 x 565mm	500	1706	300W	A, A+, C, H	89.0440	285.00	342.00

### FEATURES

- Excellent heat conductivity and lightweight
  - Only requires a low water volume
  - Heats up very quickly
  - Radiators come with cover caps on top and bottom, same as radiator colour.
  - Can be single, dual fuel or all electric
  - Tested to BS EN 442 standards
  - 5 Year Manufacturer's Warranty\*
- \* With conditions

### Technical Tables & Drawings

Page 364-365



### TECHNICAL INFORMATION

All measurements in Height by Width. Heat output based on  $\Delta T60^{\circ}C$ . For matching valves see pages 301-309. Corrosion inhibitor must be added to the heating system and maintained. Flow diverter must only be fitted when radiator installed on central heating system. For indirect heating systems only. Tappings are the width of the rail and 33 or 53mm off the wall.

### 600mm Height

#### Malmesbury Horizontal Aluminium Radiators - Matt White

Size H x W	Watts	BTU	Element Output	Element Type	Code	£ Ex VAT	£ Inc VAT
600 x 375mm	397	1355	150W	A, A+, C, H	89.0152	210.00	252.00
600 x 470mm	491	1676	300W	A, A+, C, H	89.0154	261.00	313.20
600 x 565mm	585	1997	300W	A, A+, C, H	89.0156	307.00	368.40
600 x 850mm	859	2931	450W	A, A+, C, H	89.0423	436.00	523.20
600 x 1040mm	1039	3546	600W	A, A+, C, H	89.0424	530.00	636.00
600 x 1230mm	1217	4153	750W	A, A+, C, H	89.0425	627.00	752.40
600 x 1420mm	1394	4757	900W	A, A+, C, H	89.0940	780.00	936.00

#### Malmesbury Horizontal Aluminium Radiators - Matt Grey

Size H x W	Watts	BTU	Element Output	Element Type	Code	£ Ex VAT	£ Inc VAT
600 x 375mm	397	1355	150W	A, A+, C, H	89.0274	210.00	252.00
600 x 470mm	491	1676	300W	A, A+, C, H	89.0275	261.00	313.20
600 x 565mm	585	1997	300W	A, A+, C, H	89.0276	307.00	368.40
600 x 850mm	859	2931	450W	A, A+, C, H	89.0426	436.00	523.20
600 x 1040mm	1039	3546	600W	A, A+, C, H	89.0427	530.00	636.00
600 x 1230mm	1217	4153	750W	A, A+, C, H	89.0428	627.00	752.40
600 x 1420mm	1394	4757	900W	A, A+, C, H	89.0951	780.00	936.00

#### Malmesbury Horizontal Aluminium Radiators - Matt Anthracite

Size H x W	Watts	BTU	Element Output	Element Type	Code	£ Ex VAT	£ Inc VAT
600 x 375mm	397	1355	150W	A, A+, C, H	89.0153	210.00	252.00
600 x 470mm	491	1676	300W	A, A+, C, H	89.0155	261.00	313.20
600 x 565mm	585	1997	300W	A, A+, C, H	89.0157	307.00	368.40
600 x 850mm	859	2931	450W	A, A+, C, H	89.0429	436.00	523.20
600 x 1040mm	1039	3546	600W	A, A+, C, H	89.0430	530.00	636.00
600 x 1230mm	1217	4153	750W	A, A+, C, H	89.0431	627.00	752.40
600 x 1420mm	1394	4757	900W	A, A+, C, H	89.0973	780.00	936.00

#### Malmesbury Horizontal Aluminium Radiators - Matt Cappuccino

Size H x W	Watts	BTU	Element Output	Element Type	Code	£ Ex VAT	£ Inc VAT
600 x 375mm	397	1355	150W	A, A+, C, H	89.0481	237.00	284.40
600 x 470mm	491	1676	300W	A, A+, C, H	89.0482	294.00	352.80
600 x 565mm	585	1997	300W	A, A+, C, H	89.0483	344.00	412.80
600 x 850mm	859	2931	450W	A, A+, C, H	89.0484	513.00	615.60
600 x 1040mm	1039	3546	600W	A, A+, C, H	89.0485	623.00	747.60
600 x 1230mm	1217	4153	750W	A, A+, C, H	89.0486	738.00	885.60
600 x 1420mm	1394	4757	900W	A, A+, C, H	89.0957	780.00	936.00



#### Malmesbury Cover Caps - Chrome

Description	Code	£ Ex VAT	£ Inc VAT
Cover Cap Set 375mm	89.0172	21.00	25.20
Cover Cap Set 470mm	89.0173	24.00	28.80
Cover Cap Set 565mm	89.0174	28.00	33.60
Cover Cap Set 850mm	89.0497	37.00	44.40
Cover Cap Set 1040mm	89.0498	44.00	52.80
Cover Cap Set 1230mm	89.0499	50.00	60.00
Cover Cap Set 1420mm	89.1406	55.00	66.00

Cover Caps Chrome The cover cap set only includes cover caps for the top or the bottom of the radiator.

For element types see pages 288-300.

Element can only be installed horizontally on the bottom header. Radiators that are electric only are restricted to the heat output of the elements (Type C&H can be increased up to full capacity of 900 watts).



# Aluminium Range

## MALMESBURY STANDARD TOWEL HANGERS



Towel Hanger - Matt White			
Size	Code	£ Ex VAT	£ Inc VAT
185mm	89.0298	47.00	<b>56.40</b>
280mm	89.0215	56.00	<b>67.20</b>
375mm	89.0207	63.00	<b>75.60</b>
470mm	89.0208	72.00	<b>86.40</b>
565mm	89.0209	76.00	<b>91.20</b>



Towel Hanger - Matt Grey			
Size	Code	£ Ex VAT	£ Inc VAT
185mm	89.0300	47.00	<b>56.40</b>
280mm	89.0302	56.00	<b>67.20</b>
375mm	89.0303	63.00	<b>75.60</b>
470mm	89.0304	72.00	<b>86.40</b>
565mm	89.0305	76.00	<b>91.20</b>



Towel Hanger - Matt Anthracite			
Size	Code	£ Ex VAT	£ Inc VAT
185mm	89.0299	47.00	<b>56.40</b>
280mm	89.0216	56.00	<b>67.20</b>
375mm	89.0210	63.00	<b>75.60</b>
470mm	89.0211	72.00	<b>86.40</b>
565mm	89.0212	76.00	<b>91.20</b>

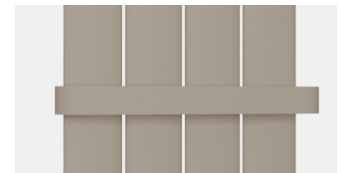

Towel Hanger - Matt Cappuccino			
Size	Code	£ Ex VAT	£ Inc VAT
185mm	89.0487	47.00	<b>56.40</b>
280mm	89.0488	56.00	<b>67.20</b>
375mm	89.0489	63.00	<b>75.60</b>
470mm	89.0490	72.00	<b>86.40</b>
565mm	89.0491	76.00	<b>91.20</b>



Towel Hanger - Chrome			
Size	Code	£ Ex VAT	£ Inc VAT
185mm	89.0301	47.00	<b>56.40</b>
280mm	89.0158	53.00	<b>63.60</b>
375mm	89.0159	56.00	<b>67.20</b>
470mm	89.0160	65.00	<b>78.00</b>
565mm	89.0176	70.00	<b>84.00</b>



### TECHNICAL INFORMATION

#### Vertical Radiators:

1200mm radiators come with 2 pre-drilled towel hanger locations with a maximum of 2 towel hangers and 1800mm height radiators come with 3 pre-drilled towel hanger locations with a maximum of 3 towel hangers - all widths; 185, 280, 375, 470 and 565mm. The standard towel hangers are only compatible with the Vertical Radiators.

**Can be fitted after installation only on high adjustment bracket fitting.**

Material: Steel

#### Horizontal Radiators:

500mm & 600mm height radiators come with 1 pre-drilled towel hanger location, with a maximum of 1 towel hanger - (only 375, 470 and 565mm widths).

Standard towel hanger can be fitted.

**Can be fitted after installation only on high adjustment bracket fitting.**

The Malmesbury Standard Towel Hangers will add approx 22mm width on each side once fitted to the radiator.

## MALMESBURY FLAT STYLE TOWEL HANGERS

### SINGLE FLAT STYLE



Towel Hanger - Matt White			
Size	Code	£ Ex VAT	£ Inc VAT
280mm	89.0306	83.00	<b>99.60</b>
375mm	89.0307	89.00	<b>106.80</b>
470mm	89.0308	92.00	<b>110.40</b>
565mm	89.0309	116.00	<b>139.20</b>



Towel Hanger - Matt Grey			
Size	Code	£ Ex VAT	£ Inc VAT
280mm	89.0314	83.00	<b>99.60</b>
375mm	89.0315	89.00	<b>106.80</b>
470mm	89.0316	92.00	<b>110.40</b>
565mm	89.0317	116.00	<b>139.20</b>



Towel Hanger - Matt Anthracite			
Size	Code	£ Ex VAT	£ Inc VAT
280mm	89.0310	83.00	<b>99.60</b>
375mm	89.0311	89.00	<b>106.80</b>
470mm	89.0312	92.00	<b>110.40</b>
565mm	89.0313	116.00	<b>139.20</b>



Towel Hanger - Matt Cappuccino			
Size	Code	£ Ex VAT	£ Inc VAT
280mm	89.0492	90.00	<b>108.00</b>
375mm	89.0493	98.00	<b>117.60</b>
470mm	89.0494	102.00	<b>122.40</b>
565mm	89.0495	128.00	<b>153.60</b>

### TECHNICAL INFORMATION

#### Vertical and Horizontal Radiators:

Single Flat style hangers are compatible with both Vertical and Horizontal radiators. (Depending on the radiators and hangers width)

**Must be fitted before installation!**

Material: Steel

Hanger Fitting Widths  
96/191/286/476mm



# Aluminium Range

## ROSANO VERTICAL

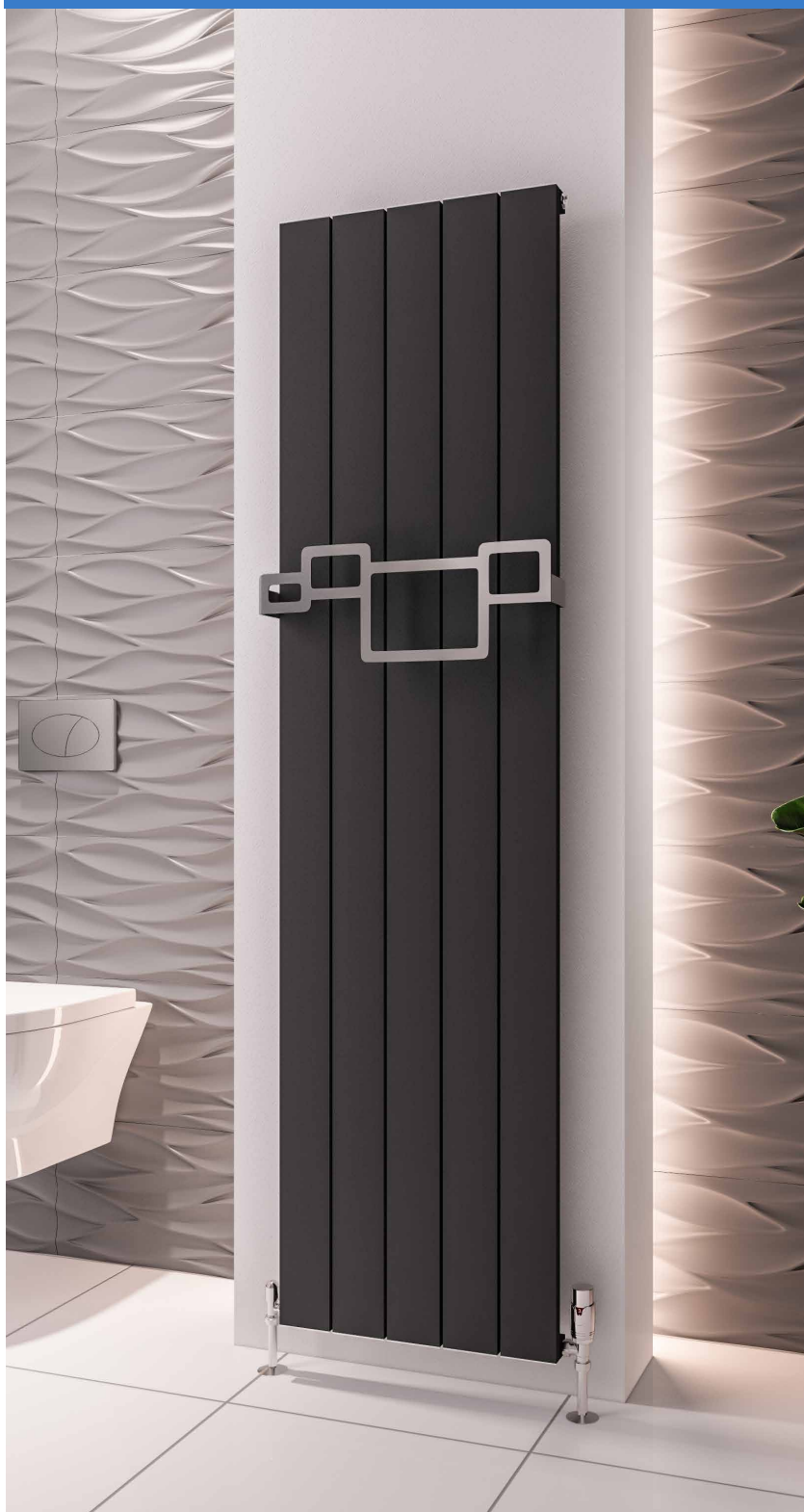

Pictured 86.0008 Matt Anthracite with 101.0085 Towel Hanger x1 & 86.0112 Cover Caps x2 (Side connection valves shown)

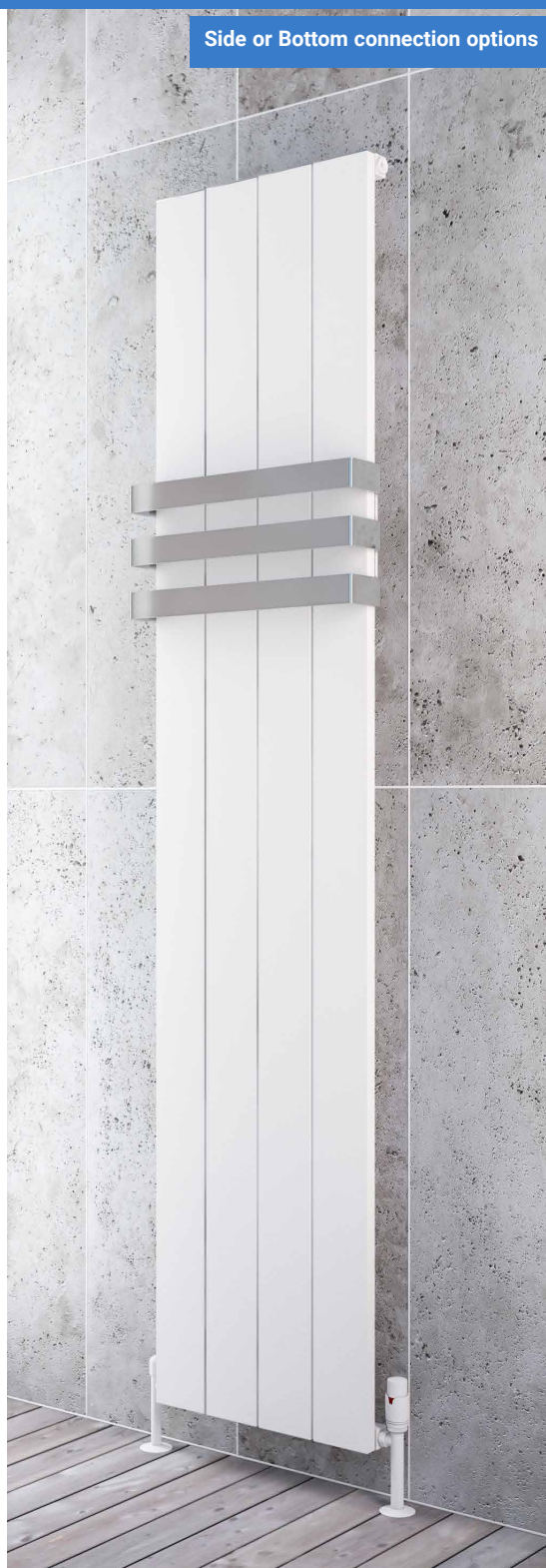

Side or Bottom connection options

Pictured 86.0004 Matt White with 101.0049 Towel Hanger x1 & 86.0112 Cover Caps x2 (Side connection valves shown)

A luxurious flat panelled radiator range with stunning clean lines which will be the focus of any room. Available in a choice of colours and in horizontal or vertical designs. Stunning towel hangers will complement the vertical design allowing room for your towels.

Warranty

**5**

Year

Heating

All Electric

Dual-Fuel

**Technical Tables & Drawings**  
Page 368-369



### TECHNICAL INFORMATION

All measurements in Height by Width. Heat output based on  $\Delta T60^{\circ}\text{C}$ . For matching valves see pages 301-309. Corrosion inhibitor must be added to the heating system and maintained. Flow diverter must only be fitted when radiator installed on central heating system. For indirect heating systems only. **Side connection:** Tappings are the width of the rail and 35 or 55mm off the wall. **Bottom connection:** Tappings are 90mm less than the width of the rail and 35 or 55mm off the wall.



# Aluminium Range

## ROSANO VERTICAL



Matt White

Matt Anthracite

Matt Black

### Rosano Vertical Aluminium Radiators - Matt White

Size H x W	Watts	BTU	Element Output	Element Type	Code	£ Ex VAT	£ Inc VAT
600 x 280mm	316	1078	150W	A, A+	86.0147	223.00	267.60
1800 x 280mm	948	3235	450W	A, A+	86.0001	361.00	433.20
1800 x 375mm	1264	4313	750W	A, A+	86.0004	460.00	552.00
1800 x 470mm	1580	5391	900W	A, A+	86.0007	562.00	674.40
1800 x 565mm	1896	6469	1000W	A, A+	86.0284	682.00	818.40

### Rosano Vertical Aluminium Radiators - Matt Anthracite

Size H x W	Watts	BTU	Element Output	Element Type	Code	£ Ex VAT	£ Inc VAT
600 x 280mm	316	1078	150W	A, A+	86.0148	223.00	267.60
1800 x 280mm	948	3235	450W	A, A+	86.0002	361.00	433.20
1800 x 375mm	1264	4313	750W	A, A+	86.0005	460.00	552.00
1800 x 470mm	1580	5391	900W	A, A+	86.0008	562.00	674.40
1800 x 565mm	1896	6469	1000W	A, A+	86.0285	682.00	818.40

### Rosano Vertical Aluminium Radiators - Matt Black

Size H x W	Watts	BTU	Element Output	Element Type	Code	£ Ex VAT	£ Inc VAT
600 x 280mm	316	1078	150W	A, A+	86.0149	223.00	267.60
1800 x 280mm	948	3235	450W	A, A+	86.0003	361.00	433.20
1800 x 375mm	1264	4313	750W	A, A+	86.0006	460.00	552.00
1800 x 470mm	1580	5391	900W	A, A+	86.0009	562.00	674.40
1800 x 565mm	1896	6469	1000W	A, A+	86.0286	682.00	818.40

Prices include radiator and wall fixing sets, valves and accessories extra.

### FEATURES

- Excellent heat conductivity and lightweight
- Only requires a low water volume
- Heats up very quickly
- Side or bottom connection options (only on vertical sizes)
- Tested to BS EN 442 standards
- 5 Year Manufacturer's Warranty\*
- Can be single or dual fuel, or all electric
- Radiators come with cover caps on top and bottom, the same colour as the radiator

\* With conditions

For element types see pages 288-300.

Element can be installed vertically on the right-hand side or left-hand side on the bottom header. Radiators that are electric only are restricted to the heat output of the elements. For dual fuel installations, element must be installed on flow side.



Pictured 86.0005 Matt Anthracite with 86.0026 Towel Hangers (bottom connection valves shown)



For all Rosano Matt White, Matt Anthracite, Matt Black, Chrome and Premium Towel Hangers, please refer to page 210-211.



### Rosano Cover Cap Sets - Chrome

Description	Code	£ Ex VAT	£ Inc VAT
Cover Cap Set 280mm	86.0111	28.00	33.60
Cover Cap Set 375mm	86.0112	34.00	40.80
Cover Cap Set 470mm	86.0113	38.00	45.60
Cover Cap Set 565mm	86.0309	46.00	55.20

Cover cap sets only include cover caps for the top of the radiator.

### Multi-Purpose Towel Hangers

Page 312



# Aluminium Range

## ROSANO HORIZONTAL

Pictured 86.0020 Matt Anthracite

Pictured 86.0021 Matt Black

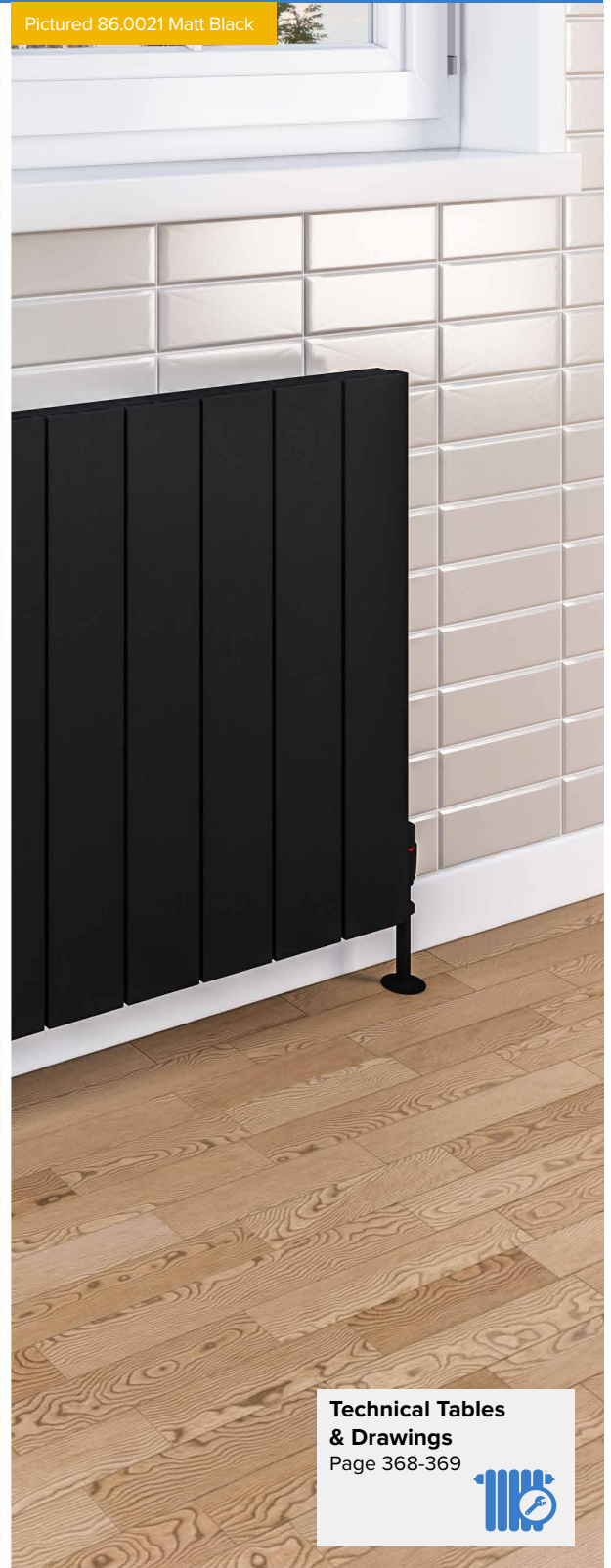
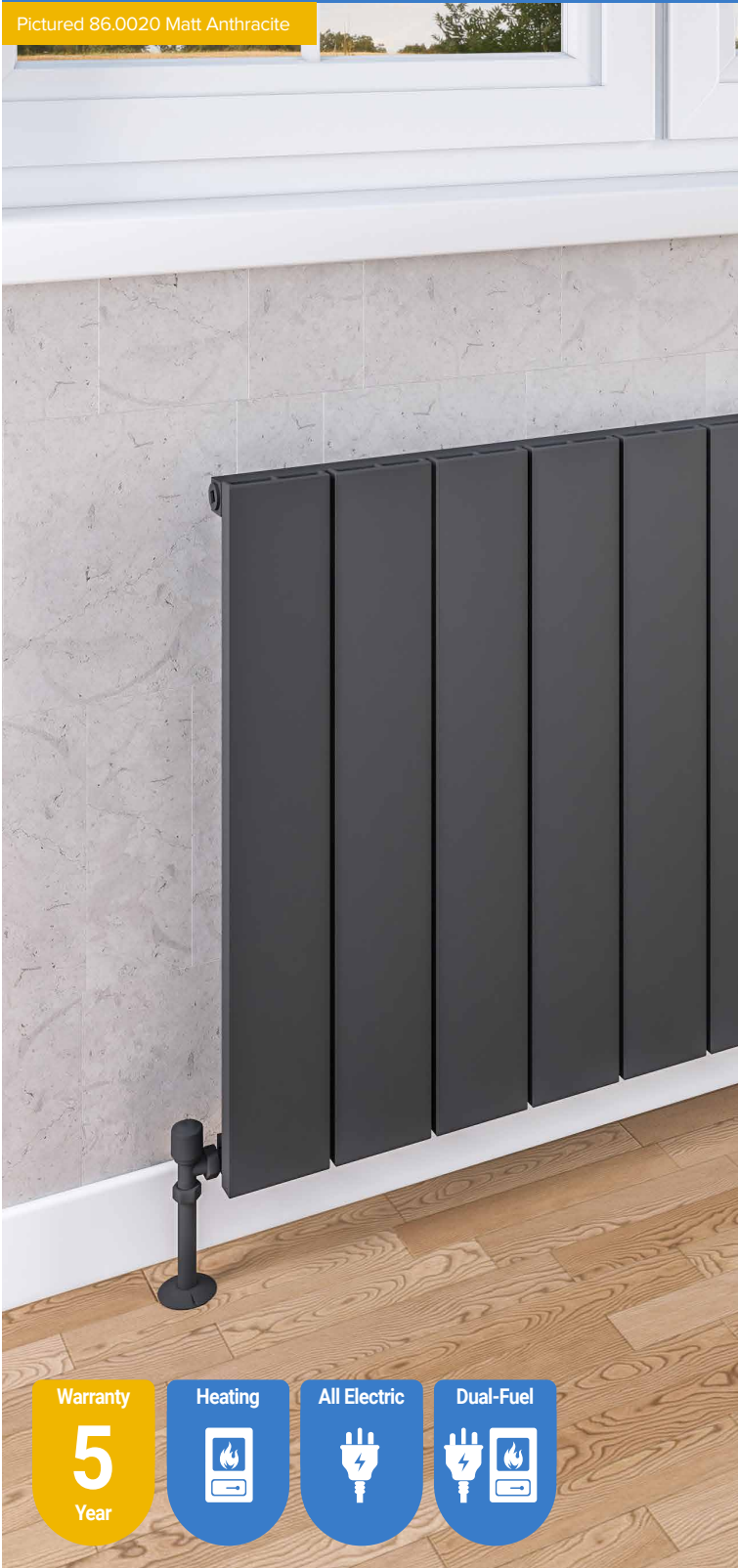



- Warranty

**5**

Year
- Heating

- All Electric

- Dual-Fuel



**Technical Tables  
& Drawings**  
Page 368-369



A luxurious flat panelled radiator range with stunning clean lines which will be the focus of any room. Available in a choice of colours and in horizontal or vertical designs.

### TECHNICAL INFORMATION

All measurements in Height by Width. Heat output based on  $\Delta T60^{\circ}\text{C}$ . For matching valves see pages 301-309. Corrosion inhibitor must be added to the heating system and maintained. Flow diverter must only be fitted when radiator installed on central heating system. For indirect heating systems only. Tappings are the width of the rail and 35 or 55mm off the wall.

### Radiator Valves

Page 301-309



# Aluminium Range

## ROSANO HORIZONTAL

Pictured 86.0016 Matt White with 89.0372 Towel Hanger



### Rosano Horizontal Aluminium Radiators - Matt White

Size H x W	Watts	BTU	Element Output	Element Type	Code	£ Ex VAT	£ Inc VAT
600 x 470mm	555	1894	300W	A, A+, C, H	86.0010	288.00	<b>345.60</b>
600 x 660mm	777	2651	450W	A, A+, C, H	86.0013	382.00	<b>458.40</b>
600 x 850mm	999	3409	600W	A, A+, C, H	86.0016	472.00	<b>566.40</b>
600 x 1040mm	1221	4166	750W	A, A+, C, H	86.0019	566.00	<b>679.20</b>
600 x 1230mm	1443	4924	900W	A, A+, C, H	86.0022	657.00	<b>788.40</b>

### Rosano Horizontal Aluminium Radiators - Matt Anthracite

Size H x W	Watts	BTU	Element Output	Element Type	Code	£ Ex VAT	£ Inc VAT
600 x 470mm	555	1894	300W	A, A+, C, H	86.0011	288.00	<b>345.60</b>
600 x 660mm	777	2651	450W	A, A+, C, H	86.0014	382.00	<b>458.40</b>
600 x 850mm	999	3409	600W	A, A+, C, H	86.0017	472.00	<b>566.40</b>
600 x 1040mm	1221	4166	750W	A, A+, C, H	86.0020	566.00	<b>679.20</b>
600 x 1230mm	1443	4924	900W	A, A+, C, H	86.0023	657.00	<b>788.40</b>

### Rosano Horizontal Aluminium Radiators - Matt Black

Size H x W	Watts	BTU	Element Output	Element Type	Code	£ Ex VAT	£ Inc VAT
600 x 470mm	555	1894	300W	A, A+, C, H	86.0012	288.00	<b>345.60</b>
600 x 660mm	777	2651	450W	A, A+, C, H	86.0015	382.00	<b>458.40</b>
600 x 850mm	999	3409	600W	A, A+, C, H	86.0018	472.00	<b>566.40</b>
600 x 1040mm	1221	4166	750W	A, A+, C, H	86.0021	566.00	<b>679.20</b>
600 x 1230mm	1443	4924	900W	A, A+, C, H	86.0024	657.00	<b>788.40</b>

Prices include radiator and wall fixing sets, valves and accessories extra.

#### FEATURES

- Excellent heat conductivity and lightweight
- Only requires a low water volume
- Heats up very quickly
- Tested to BS EN 442 standards
- 5 Year Manufacturer's Warranty\*
- Can be single or dual fuel, or all electric
- Radiators come with cover caps on top and bottom, the same colour as the radiator

\* With conditions

For element types see pages 288-300.

Element can only be installed horizontally on the bottom header. Radiators that are electric only are restricted to the heat output of the elements (Type C&H up to 900 watts).



#### Matt White

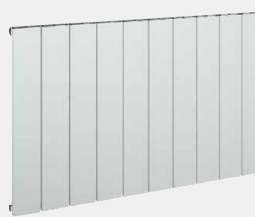

#### Matt Anthracite

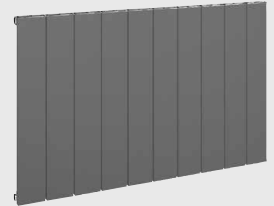

#### Matt Black

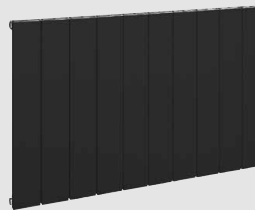

For all Rosano Matt White, Matt Anthracite, Matt Black, Chrome and Premium Towel Hangers, please refer to page 210-211.



#### Rosano Cover Cap Sets - Chrome

Description	Code	£ Ex VAT	£ Inc VAT
Cover Cap Set 470mm	86.0113	38.00	<b>45.60</b>
Cover Cap Set 660mm	86.0114	50.00	<b>60.00</b>
Cover Cap Set 850mm	86.0115	60.00	<b>72.00</b>
Cover Cap Set 1040mm	86.0116	70.00	<b>84.00</b>
Cover Cap Set 1230mm	86.0117	83.00	<b>99.60</b>

Cover cap sets only include cover caps for the top of the radiator.

# Aluminium Range

## ROSANO STANDARD TOWEL HANGERS



Towel Hanger - Matt White			
Size	Code	£ Ex VAT	£ Inc VAT
280mm	89.0177	62.00	<b>74.40</b>
375mm	89.0178	66.00	<b>79.20</b>
470mm	89.0179	74.00	<b>88.80</b>
565mm	86.0333	78.00	<b>93.60</b>



Towel Hanger - Matt Anthracite			
Size	Code	£ Ex VAT	£ Inc VAT
280mm	89.0180	62.00	<b>74.40</b>
375mm	89.0181	66.00	<b>79.20</b>
470mm	89.0182	74.00	<b>88.80</b>
565mm	86.0334	78.00	<b>93.60</b>

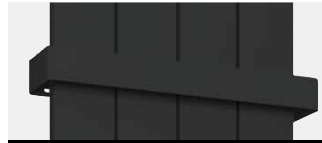

Towel Hanger - Matt Black			
Size	Code	£ Ex VAT	£ Inc VAT
280mm	89.0183	62.00	<b>74.40</b>
375mm	89.0184	66.00	<b>79.20</b>
470mm	89.0185	74.00	<b>88.80</b>
565mm	86.0335	78.00	<b>93.60</b>



Towel Hanger - Chrome			
Size	Code	£ Ex VAT	£ Inc VAT
280mm	86.0025	53.00	<b>63.60</b>
375mm	86.0026	62.00	<b>74.40</b>
470mm	86.0027	69.00	<b>82.80</b>
565mm	86.0336	72.00	<b>86.40</b>

### TECHNICAL INFORMATION

Material: **Steel (Premium: Stainless Steel - Grade 304)**

1800mm height radiators come with 3 pre-drilled towel hanger locations with a maximum of 3 towel hangers - all widths; 280, 375, 470 and 565mm. 600mm height radiators come with 1 pre-drilled towel hanger location, with a maximum of 1 towel hanger - 280mm width. The Rosano Standard Towel Hangers will add approx 8mm width on each side once fitted to the radiator.

600mm height x 470mm width radiator can have one towel hanger.

Can be fitted after installation only on high adjustment bracket fitting.

Due in November 2023



Towel Hanger - Brushed Brass			
Size	Code	£ Ex VAT	£ Inc VAT
280mm	41.0616	56.00	<b>67.20</b>
375mm	41.0617	63.00	<b>75.60</b>
470mm	41.0618	72.00	<b>86.40</b>
565mm	41.0619	76.00	<b>91.20</b>



Towel Hanger - Mirror Polished Premium			
Size	Code	£ Ex VAT	£ Inc VAT
280mm	86.0198	73.00	<b>87.60</b>
375mm	86.0199	80.00	<b>96.00</b>
470mm	86.0200	87.00	<b>104.40</b>
565mm	86.0337	93.00	<b>111.60</b>

## ROSANO FLAT STYLE TOWEL HANGERS

### SINGLE FLAT STYLE



Towel Hanger - Matt White			
Size	Code	£ Ex VAT	£ Inc VAT
280mm	89.0283	72.00	<b>86.40</b>
375mm	89.0284	79.00	<b>94.80</b>
470mm	89.0285	89.00	<b>106.80</b>
565mm	91.0163	95.00	<b>114.00</b>
660mm	89.0286	100.00	<b>120.00</b>
850mm	89.0287	112.00	<b>134.40</b>

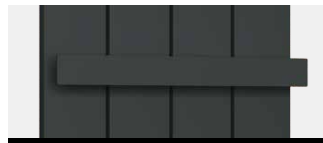

Towel Hanger - Matt Anthracite			
Size	Code	£ Ex VAT	£ Inc VAT
280mm	89.0288	72.00	<b>86.40</b>
375mm	89.0289	79.00	<b>94.80</b>
470mm	89.0290	89.00	<b>106.80</b>
565mm	91.0164	95.00	<b>114.00</b>
660mm	89.0291	100.00	<b>120.00</b>
850mm	89.0292	112.00	<b>134.40</b>

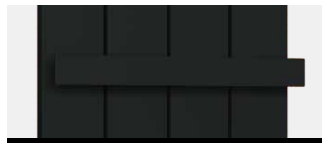

Towel Hanger - Matt Black			
Size	Code	£ Ex VAT	£ Inc VAT
280mm	89.0293	72.00	<b>86.40</b>
375mm	89.0294	79.00	<b>94.80</b>
470mm	89.0295	89.00	<b>106.80</b>
565mm	91.0165	95.00	<b>114.00</b>
660mm	89.0296	100.00	<b>120.00</b>
850mm	89.0297	112.00	<b>134.40</b>



Towel Hanger - Chrome			
Size	Code	£ Ex VAT	£ Inc VAT
280mm	91.0094	98.00	<b>117.60</b>
375mm	91.0095	100.00	<b>120.00</b>
470mm	91.0096	102.00	<b>122.40</b>
565mm	91.0166	103.00	<b>123.60</b>
660mm	91.0097	108.00	<b>129.60</b>
850mm	91.0098	115.00	<b>138.00</b>

### DOUBLE FLAT STYLE



Towel Hanger - Matt White			
Size	Code	£ Ex VAT	£ Inc VAT
280mm	89.0369	88.00	<b>105.60</b>
375mm	89.0370	92.00	<b>110.40</b>
470mm	89.0371	103.00	<b>123.60</b>
565mm	91.0167	114.00	<b>136.80</b>
660mm	89.0372	121.00	<b>145.20</b>
850mm	89.0373	135.00	<b>162.00</b>

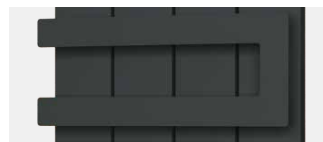

Towel Hanger - Matt Anthracite			
Size	Code	£ Ex VAT	£ Inc VAT
280mm	89.0374	88.00	<b>105.60</b>
375mm	89.0375	92.00	<b>110.40</b>
470mm	89.0376	103.00	<b>123.60</b>
565mm	91.0168	114.00	<b>136.80</b>
660mm	89.0377	121.00	<b>145.20</b>
850mm	89.0378	135.00	<b>162.00</b>

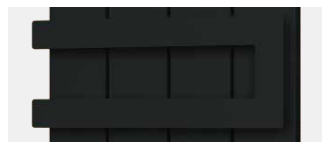

Towel Hanger - Matt Black			
Size	Code	£ Ex VAT	£ Inc VAT
280mm	89.0379	88.00	<b>105.60</b>
375mm	89.0380	92.00	<b>110.40</b>
470mm	89.0381	103.00	<b>123.60</b>
565mm	91.0169	114.00	<b>136.80</b>
660mm	89.0382	121.00	<b>145.20</b>
850mm	89.0383	135.00	<b>162.00</b>



Towel Hanger - Chrome			
Size	Code	£ Ex VAT	£ Inc VAT
280mm	91.0114	124.00	<b>148.80</b>
375mm	91.0115	130.00	<b>156.00</b>
470mm	91.0116	132.00	<b>158.40</b>
565mm	91.0170	138.00	<b>165.60</b>
660mm	91.0117	142.00	<b>170.40</b>
850mm	91.0118	154.00	<b>184.80</b>

### TECHNICAL INFORMATION

Material: **Steel**

#### Vertical and Horizontal Radiators:

Flat & Double Flat Style Hangers are compatible with both Vertical and Horizontal radiators. (Depending on the radiators and hangers width)

Must be fitted before installation!

Hanger Fitting Widths  
96/191/286/381/476/666mm



Hanger Fitting Widths  
96/191/286/381/476/666mm

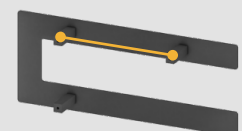

# Aluminium Range

## ROSANO FLAT TRIPLE TOWEL HANGER

### Brushed Stainless Steel



### Polished Stainless Steel



#### Flat Triple Hanger - Brushed Stainless Steel

Size	Code	£ Ex VAT	£ Inc VAT
280mm	101.0048	240.00	<b>288.00</b>
375mm	101.0049	261.00	<b>313.20</b>
470mm	101.0050	299.00	<b>358.80</b>
565mm	101.0064	335.00	<b>402.00</b>

#### Flat Triple Hanger - Polished Stainless Steel

Size	Code	£ Ex VAT	£ Inc VAT
280mm	101.0054	240.00	<b>288.00</b>
375mm	101.0055	261.00	<b>313.20</b>
470mm	101.0056	299.00	<b>358.80</b>
565mm	101.0065	335.00	<b>402.00</b>

## ROSANO CURVED TRIPLE TOWEL HANGER

### Brushed Stainless Steel



### Polished Stainless Steel



#### Curved Triple Hanger - Brushed Stainless Steel

Size	Code	£ Ex VAT	£ Inc VAT
280mm	101.0051	240.00	<b>288.00</b>
375mm	101.0052	261.00	<b>313.20</b>
470mm	101.0053	299.00	<b>358.80</b>
565mm	101.0066	335.00	<b>402.00</b>

#### Curved Triple Hanger - Polished Stainless Steel

Size	Code	£ Ex VAT	£ Inc VAT
280mm	101.0057	240.00	<b>288.00</b>
375mm	101.0058	261.00	<b>313.20</b>
470mm	101.0059	299.00	<b>358.80</b>
565mm	101.0067	335.00	<b>402.00</b>

Material: **Stainless Steel - Grade 304**

### TECHNICAL INFORMATION

#### Vertical Radiators:

1800mm height radiators comes with 3 pre-drilled towel hanger locations. 600mm height radiators come with 1 pre-drilled towel hanger location. The flat triple & curved triple towel hangers are only compatible with the Vertical Radiators and can be fitted to the pre-drilled holes on 1800mm & 600mm height radiators. **Can be fitted after installation only on high adjustment bracket fitting.**

#### Horizontal Radiators:

The flat triple & curved triple towel hangers are not suitable for horizontal radiators.

## ROSANO DESIGNER TOWEL HANGERS

### Square Style



#### Square Towel Hanger - Matt White

Size	Code	£ Ex VAT	£ Inc VAT
375mm	101.0075	72.00	<b>86.40</b>
470mm	101.0076	79.00	<b>94.80</b>
565mm	101.0077	92.00	<b>110.40</b>

#### Square Towel Hanger - Matt Anthracite

Size	Code	£ Ex VAT	£ Inc VAT
375mm	101.0078	72.00	<b>86.40</b>
470mm	101.0079	79.00	<b>94.80</b>
565mm	101.0080	92.00	<b>110.40</b>

#### Square Towel Hanger - Matt Black

Size	Code	£ Ex VAT	£ Inc VAT
375mm	101.0081	72.00	<b>86.40</b>
470mm	101.0082	79.00	<b>94.80</b>
565mm	101.0083	92.00	<b>110.40</b>

#### Square Towel Hanger - Chrome

Size	Code	£ Ex VAT	£ Inc VAT
375mm	101.0084	83.00	<b>99.60</b>
470mm	101.0085	96.00	<b>115.20</b>
565mm	101.0086	112.00	<b>134.40</b>

### Triangle Style



#### Triangle Towel Hanger - Matt White

Size	Code	£ Ex VAT	£ Inc VAT
375mm	101.0087	74.00	<b>88.80</b>
470mm	101.0088	83.00	<b>99.60</b>
565mm	101.0089	97.00	<b>116.40</b>

#### Triangle Towel Hanger - Matt Anthracite

Size	Code	£ Ex VAT	£ Inc VAT
375mm	101.0090	74.00	<b>88.80</b>
470mm	101.0091	83.00	<b>99.60</b>
565mm	101.0092	97.00	<b>116.40</b>

#### Triangle Towel Hanger - Matt Black

Size	Code	£ Ex VAT	£ Inc VAT
375mm	101.0093	74.00	<b>88.80</b>
470mm	101.0094	83.00	<b>99.60</b>
565mm	101.0095	97.00	<b>116.40</b>

#### Triangle Towel Hanger - Chrome

Size	Code	£ Ex VAT	£ Inc VAT
375mm	101.0096	84.00	<b>100.80</b>
470mm	101.0097	97.00	<b>116.40</b>
565mm	101.0098	115.00	<b>138.00</b>

### Circle Style



#### Circle Towel Hanger - Matt White

Size	Code	£ Ex VAT	£ Inc VAT
375mm	101.0099	78.00	<b>93.60</b>
470mm	101.0100	86.00	<b>103.20</b>
565mm	101.0101	100.00	<b>120.00</b>

#### Circle Towel Hanger - Matt Anthracite

Size	Code	£ Ex VAT	£ Inc VAT
375mm	101.0102	78.00	<b>93.60</b>
470mm	101.0103	86.00	<b>103.20</b>
565mm	101.0104	100.00	<b>120.00</b>

#### Circle Towel Hanger - Matt Black

Size	Code	£ Ex VAT	£ Inc VAT
375mm	101.0105	78.00	<b>93.60</b>
470mm	101.0106	86.00	<b>103.20</b>
565mm	101.0107	100.00	<b>120.00</b>

#### Circle Towel Hanger - Chrome

Size	Code	£ Ex VAT	£ Inc VAT
375mm	101.0108	84.00	<b>100.80</b>
470mm	101.0109	98.00	<b>117.60</b>
565mm	101.0110	116.00	<b>139.20</b>

Material: **Steel**

### TECHNICAL INFORMATION

Square, Triangle and Circle Towel Hangers are only compatible with vertical radiators and can be fitted to one of the three pre-drilled holes on the 1800mm height radiators. Square, Triangle and Circle Towel Hangers will add approx 8mm width on each side once fitted to the radiator. **Can be fitted after installation only on high adjustment bracket fitting.**

# Aluminium Range

## PERETTI VERTICAL

Side or Bottom connection options



Pictured 86.0178 Polished Aluminium with 86.0078 Towel Hangers (side connection valves shown)



Pictured 86.0060 Matt Black with 101.0109 Towel Hanger x1 (bottom connection valves shown)

A refined version of the designer flat panelled radiators with a curve to the end two panels. This radiator will add a touch of sophistication creating an impact in any room. Available in both vertical and horizontal designs as well as four different colours for maximum choice. Stunning towel hangers will complement the vertical design allowing room for your towels.

### FEATURES

- Excellent heat conductivity and lightweight
- Only requires a low water volume
- Heats up very quickly
- Side or bottom connection options (only on vertical sizes)
- Tested to BS EN 442 standards
- 5 Year Manufacturer's Warranty\*
- Can be single or dual fuel, or all electric
- Radiators come with cover caps on top and bottom, the same colour as the radiator

\* With conditions

### Technical Tables & Drawings

Page 368-369



<p>Warranty</p> <p><b>5</b></p> <p>Year</p>	<p>Heating</p>	<p>All Electric</p>	<p>Dual-Fuel</p>
---	----------------	---------------------	------------------

For all Peretti Matt White, Matt Anthracite, Matt Black, Chrome and Premium Towel Hangers, please refer to page 216-217.



### TECHNICAL INFORMATION

All measurements in Height by Width. Heat output based on  $\Delta T60^{\circ}\text{C}$ . For matching valves see pages 301-309. Corrosion inhibitor must be added to the heating system and maintained. Flow diverter must only be fitted when radiator installed on central heating system. For indirect heating systems only. **Side connection:** Tappings are the width of the rail and 35 or 55mm off the wall. **Bottom connection:** Tappings are 90mm less than the width of the rail and 35 or 55mm off the wall.

# Aluminium Range

## PERETTI VERTICAL



Matt White    Matt Anthracite    Matt Black    Polished

### Peretti Vertical Aluminium Radiators - Matt White

Size H x W	Watts	BTU	Element Output	Element Type	Code	£ Ex VAT	£ Inc VAT
600 x 280mm	316	1078	150W	A, A+	86.0150	223.00	<b>267.60</b>
1800 x 280mm	948	3235	450W	A, A+	86.0053	361.00	<b>433.20</b>
1800 x 375mm	1264	4313	750W	A, A+	86.0056	460.00	<b>552.00</b>
1800 x 470mm	1580	5391	900W	A, A+	86.0059	562.00	<b>674.40</b>
1800 x 565mm	1896	6469	1000W	A, A+	86.0287	682.00	<b>818.40</b>

### Peretti Vertical Aluminium Radiators - Matt Anthracite

Size H x W	Watts	BTU	Element Output	Element Type	Code	£ Ex VAT	£ Inc VAT
600 x 280mm	316	1078	150W	A, A+	86.0151	223.00	<b>267.60</b>
1800 x 280mm	948	3235	450W	A, A+	86.0054	361.00	<b>433.20</b>
1800 x 375mm	1264	4313	750W	A, A+	86.0057	460.00	<b>552.00</b>
1800 x 470mm	1580	5391	900W	A, A+	86.0060	562.00	<b>674.40</b>
1800 x 565mm	1896	6469	1000W	A, A+	86.0288	682.00	<b>818.40</b>

### Peretti Vertical Aluminium Radiators - Matt Black

Size H x W	Watts	BTU	Element Output	Element Type	Code	£ Ex VAT	£ Inc VAT
600 x 280mm	316	1078	150W	A, A+	86.0152	223.00	<b>267.60</b>
1800 x 280mm	948	3235	450W	A, A+	86.0055	361.00	<b>433.20</b>
1800 x 375mm	1264	4313	750W	A, A+	86.0058	460.00	<b>552.00</b>
1800 x 470mm	1580	5391	900W	A, A+	86.0061	562.00	<b>674.40</b>
1800 x 565mm	1896	6469	1000W	A, A+	86.0289	682.00	<b>818.40</b>

### Peretti Vertical Aluminium Radiators - Polished Aluminium

Size H x W	Watts	BTU	Element Output	Element Type	Code	£ Ex VAT	£ Inc VAT
600 x 280mm	307	1046	150W	A, A+	86.0176	243.00	<b>291.60</b>
1800 x 280mm	920	3138	450W	A, A+	86.0177	424.00	<b>508.80</b>
1800 x 375mm	1226	4184	750W	A, A+	86.0178	543.00	<b>651.60</b>
1800 x 470mm	1533	5229	900W	A, A+	86.0179	663.00	<b>795.60</b>
1800 x 565mm	1839	6275	1000W	A, A+	86.0290	767.00	<b>920.40</b>

Prices include radiator and wall fixing sets, valves and accessories extra.

For element types see pages 288-300.

Element can be installed vertically on the right-hand side or left-hand side on the bottom header. Radiators that are electric only are restricted to the heat output of the elements. For dual fuel installations, element must be installed on flow side.



Pictured 86.0056 Matt White (side connection valves shown)



### Peretti Cover Cap Sets - Chrome

Description	Code	£ Ex VAT	£ Inc VAT
Cover Cap Set 280mm	86.0125	28.00	<b>33.60</b>
Cover Cap Set 375mm	86.0126	34.00	<b>40.80</b>
Cover Cap Set 470mm	86.0113	38.00	<b>45.60</b>
Cover Cap Set 565mm	86.0310	46.00	<b>55.20</b>

Cover cap sets only include cover caps for the top of the radiator.

### Multi-Purpose Towel Hangers

Page 312





# Aluminium Range

## PERETTI HORIZONTAL

Pictured 86.0183 Polished Aluminium with 91.0117 Towel Hanger



Warranty <b>5</b> Year	Heating 	All Electric 	Dual-Fuel 
------------------------------	--	---	--

**Technical Tables & Drawings**  
 Page 368-369



A refined version of the designer flat panelled radiators with a curve to the end two panels. This radiator will add a touch of sophistication creating an impact in any room. Available in both vertical and horizontal designs as well as four different colours for maximum choice. Stunning towel hangers will complement the vertical design allowing room for your towels.

**FEATURES**

- Excellent heat conductivity and lightweight
  - Only requires a low water volume
  - Heats up very quickly
  - Tested to BS EN 442 standards
  - 5 Year Manufacturer's Warranty\*
  - Can be single or dual fuel, or all electric
  - Radiators come with cover caps on top and bottom, the same colour as the radiator
- \* With conditions

**TECHNICAL INFORMATION**

All measurements in Height by Width. Heat output based on  $\Delta T60^{\circ}C$ . For matching valves see pages 301-309. Corrosion inhibitor must be added to the heating system and maintained. Flow diverter must only be fitted when radiator installed on central heating system. For indirect heating systems only. Tappings are the width of the rail and 35 or 55mm off the wall.

For all Peretti Matt White, Matt Anthracite, Matt Black, Chrome and Premium Towel Hangers, please refer to page 216-217.



**Radiator Valves**  
 Page 301-309

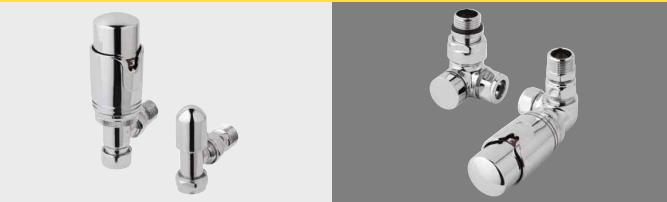



# Aluminium Range

## PERETTI HORIZONTAL

Pictured 86.0069 Matt Anthracite with 89.0290 Towel Hanger



### Peretti Horizontal Aluminium Radiators - Matt White

Size H x W	Watts	BTU	Element Output	Element Type	Code	£ Ex VAT	£ Inc VAT
600 x 470mm	555	1894	300W	A, A+, C, H	86.0062	288.00	345.60
600 x 660mm	777	2651	450W	A, A+, C, H	86.0065	382.00	458.40
600 x 850mm	999	3409	600W	A, A+, C, H	86.0068	472.00	566.40
600 x 1040mm	1221	4166	750W	A, A+, C, H	86.0071	566.00	679.20
600 x 1230mm	1443	4924	900W	A, A+, C, H	86.0074	658.00	789.60

### Peretti Horizontal Aluminium Radiators - Matt Anthracite

Size H x W	Watts	BTU	Element Output	Element Type	Code	£ Ex VAT	£ Inc VAT
600 x 470mm	555	1894	300W	A, A+, C, H	86.0063	281.00	337.20
600 x 660mm	777	2651	450W	A, A+, C, H	86.0066	382.00	458.40
600 x 850mm	999	3409	600W	A, A+, C, H	86.0069	472.00	566.40
600 x 1040mm	1221	4166	750W	A, A+, C, H	86.0072	566.00	679.20
600 x 1230mm	1443	4924	900W	A, A+, C, H	86.0075	658.00	789.60

### Peretti Horizontal Aluminium Radiators - Matt Black

Size H x W	Watts	BTU	Element Output	Element Type	Code	£ Ex VAT	£ Inc VAT
600 x 470mm	555	1894	300W	A, A+, C, H	86.0064	288.00	345.60
600 x 660mm	777	2651	450W	A, A+, C, H	86.0067	382.00	458.40
600 x 850mm	999	3409	600W	A, A+, C, H	86.0070	472.00	566.40
600 x 1040mm	1221	4166	750W	A, A+, C, H	86.0073	566.00	679.20
600 x 1230mm	1443	4924	900W	A, A+, C, H	86.0076	658.00	789.60

### Peretti Horizontal Aluminium Radiators - Polished Aluminium

Size H x W	Watts	BTU	Element Output	Element Type	Code	£ Ex VAT	£ Inc VAT
600 x 470mm	538	1837	300W	A, A+, C, H	86.0180	341.00	409.20
600 x 660mm	754	2571	450W	A, A+, C, H	86.0181	451.00	541.20
600 x 850mm	969	3307	600W	A, A+, C, H	86.0182	558.00	669.60
600 x 1040mm	1184	4041	750W	A, A+, C, H	86.0183	666.00	799.20
600 x 1230mm	1400	4776	900W	A, A+, C, H	86.0184	776.00	931.20

Prices include radiator and wall fixing sets, valves and accessories extra.

For element types  
see pages 288-300.

Element can only be installed horizontally on the bottom header. Radiators that are electric only are restricted to the heat output of the elements (Type C&H up to 900 watts).



#### Matt White



#### Matt Anthracite

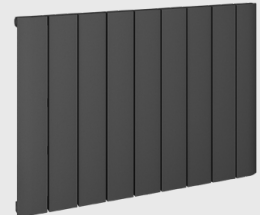

#### Matt Black

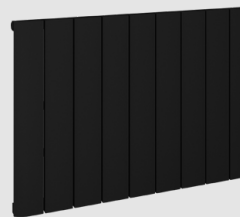

#### Polished Aluminium



### Peretti Cover Cap Sets - Chrome

Description	Code	£ Ex VAT	£ Inc VAT
Cover Cap Set 470mm	86.0127	38.00	45.60
Cover Cap Set 660mm	86.0128	50.00	60.00
Cover Cap Set 850mm	86.0129	60.00	72.00
Cover Cap Set 1040mm	86.0130	76.00	91.20
Cover Cap Set 1230mm	86.0131	83.00	99.60

Cover cap sets only include cover caps for the top of the radiator.

# Aluminium Range

## PERETTI STANDARD TOWEL HANGERS



Towel Hanger - Matt White			
Size	Code	£ Ex VAT	£ Inc VAT
280mm	89.0186	62.00	<b>74.40</b>
375mm	89.0187	66.00	<b>79.20</b>
470mm	89.0188	74.00	<b>88.80</b>
565mm	86.0338	78.00	<b>93.60</b>



Towel Hanger - Matt Anthracite			
Size	Code	£ Ex VAT	£ Inc VAT
280mm	89.0189	62.00	<b>74.40</b>
375mm	89.0190	66.00	<b>79.20</b>
470mm	89.0191	74.00	<b>88.80</b>
565mm	86.0339	78.00	<b>93.60</b>



Towel Hanger - Matt Black			
Size	Code	£ Ex VAT	£ Inc VAT
280mm	89.0192	62.00	<b>74.40</b>
375mm	89.0193	66.00	<b>79.20</b>
470mm	89.0194	74.00	<b>88.80</b>
565mm	86.0340	78.00	<b>93.60</b>



Towel Hanger - Chrome			
Size	Code	£ Ex VAT	£ Inc VAT
280mm	86.0077	53.00	<b>63.60</b>
375mm	86.0078	62.00	<b>74.40</b>
470mm	86.0079	69.00	<b>82.80</b>
565mm	86.0341	72.00	<b>86.40</b>

### TECHNICAL INFORMATION

Material: **Steel (Premium: Stainless Steel - Grade 304)**

1800mm height radiators come with 3 pre-drilled towel hanger locations with a maximum of 3 towel hangers - all widths; 280, 375, 470 and 565mm. 600mm height radiators come with 1 pre-drilled towel hanger location, with a maximum of 1 towel hanger - 280mm width. The Peretti Standard Towel Hangers will add approx 8mm width on each side once fitted to the radiator.

600mm height x 470mm width radiator can have one towel hanger.

**Can be fitted after installation only on high adjustment bracket fitting.**

**Due in November 2023**



Towel Hanger - Brushed Brass			
Size	Code	£ Ex VAT	£ Inc VAT
280mm	41.0612	59.00	<b>70.80</b>
375mm	41.0613	68.00	<b>81.60</b>
470mm	41.0614	77.00	<b>92.40</b>
565mm	41.0615	81.00	<b>97.20</b>



Towel Hanger - Mirror Polished Premium			
Size	Code	£ Ex VAT	£ Inc VAT
280mm	86.0201	73.00	<b>87.60</b>
375mm	86.0202	80.00	<b>96.00</b>
470mm	86.0203	87.00	<b>104.40</b>
565mm	86.0342	93.00	<b>111.60</b>

## PERETTI FLAT STYLE TOWEL HANGERS

### SINGLE FLAT STYLE



Towel Hanger - Matt White			
Size	Code	£ Ex VAT	£ Inc VAT
280mm	89.0283	72.00	<b>86.40</b>
375mm	89.0284	79.00	<b>94.80</b>
470mm	89.0285	89.00	<b>106.80</b>
565mm	91.0163	95.00	<b>114.00</b>
660mm	89.0286	100.00	<b>120.00</b>
850mm	89.0287	112.00	<b>134.40</b>

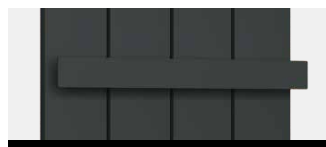

Towel Hanger - Matt Anthracite			
Size	Code	£ Ex VAT	£ Inc VAT
280mm	89.0288	72.00	<b>86.40</b>
375mm	89.0289	79.00	<b>94.80</b>
470mm	89.0290	89.00	<b>106.80</b>
565mm	91.0164	95.00	<b>114.00</b>
660mm	89.0291	100.00	<b>120.00</b>
850mm	89.0292	112.00	<b>134.40</b>

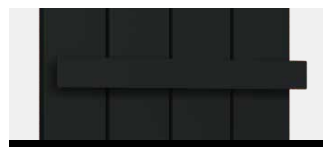

Towel Hanger - Matt Black			
Size	Code	£ Ex VAT	£ Inc VAT
280mm	89.0293	72.00	<b>86.40</b>
375mm	89.0294	79.00	<b>94.80</b>
470mm	89.0295	89.00	<b>106.80</b>
565mm	91.0165	95.00	<b>114.00</b>
660mm	89.0296	100.00	<b>120.00</b>
850mm	89.0297	112.00	<b>134.40</b>



Towel Hanger - Chrome			
Size	Code	£ Ex VAT	£ Inc VAT
280mm	91.0094	98.00	<b>117.60</b>
375mm	91.0095	100.00	<b>120.00</b>
470mm	91.0096	102.00	<b>122.40</b>
565mm	91.0166	103.00	<b>123.60</b>
660mm	91.0097	108.00	<b>129.60</b>
850mm	91.0098	115.00	<b>138.00</b>

### DOUBLE FLAT STYLE



Towel Hanger - Matt White			
Size	Code	£ Ex VAT	£ Inc VAT
280mm	89.0369	88.00	<b>105.60</b>
375mm	89.0370	92.00	<b>110.40</b>
470mm	89.0371	103.00	<b>123.60</b>
565mm	91.0167	114.00	<b>136.80</b>
660mm	89.0372	121.00	<b>145.20</b>
850mm	89.0373	135.00	<b>162.00</b>

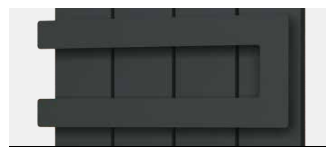

Towel Hanger - Matt Anthracite			
Size	Code	£ Ex VAT	£ Inc VAT
280mm	89.0374	88.00	<b>105.60</b>
375mm	89.0375	92.00	<b>110.40</b>
470mm	89.0376	103.00	<b>123.60</b>
565mm	91.0168	114.00	<b>136.80</b>
660mm	89.0377	121.00	<b>145.20</b>
850mm	89.0378	135.00	<b>162.00</b>

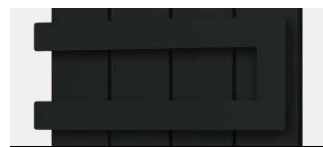

Towel Hanger - Matt Black			
Size	Code	£ Ex VAT	£ Inc VAT
280mm	89.0379	88.00	<b>105.60</b>
375mm	89.0380	92.00	<b>110.40</b>
470mm	89.0381	103.00	<b>123.60</b>
565mm	91.0169	114.00	<b>136.80</b>
660mm	89.0382	121.00	<b>145.20</b>
850mm	89.0383	135.00	<b>162.00</b>



Towel Hanger - Chrome			
Size	Code	£ Ex VAT	£ Inc VAT
280mm	91.0114	124.00	<b>148.80</b>
375mm	91.0115	130.00	<b>156.00</b>
470mm	91.0116	132.00	<b>158.40</b>
565mm	91.0170	138.00	<b>165.60</b>
660mm	91.0117	142.00	<b>170.40</b>
850mm	91.0118	154.00	<b>184.80</b>

### TECHNICAL INFORMATION

Material: **Steel**

#### Vertical and Horizontal Radiators:

Flat & Double Flat Style Hangers are compatible with both Vertical and Horizontal radiators. (Depending on the radiators and hangers width)

**Must be fitted before installation!**



# Aluminium Range

## PERETTI FLAT TRIPLE TOWEL HANGER

### Brushed Stainless Steel



### Polished Stainless Steel



#### Flat Triple Hanger - Brushed Stainless Steel

Size	Code	£ Ex VAT	£ Inc VAT
280mm	101.0048	240.00	<b>288.00</b>
375mm	101.0049	261.00	<b>313.20</b>
470mm	101.0050	299.00	<b>358.80</b>
565mm	101.0064	335.00	<b>402.00</b>

#### Flat Triple Hanger - Polished Stainless Steel

Size	Code	£ Ex VAT	£ Inc VAT
280mm	101.0054	240.00	<b>288.00</b>
375mm	101.0055	261.00	<b>313.20</b>
470mm	101.0056	299.00	<b>358.80</b>
565mm	101.0065	335.00	<b>402.00</b>

## PERETTI CURVED TRIPLE TOWEL HANGER

### Brushed Stainless Steel



### Polished Stainless Steel



#### Curved Triple Hanger - Brushed Stainless Steel

Size	Code	£ Ex VAT	£ Inc VAT
280mm	101.0051	240.00	<b>288.00</b>
375mm	101.0052	261.00	<b>313.20</b>
470mm	101.0053	299.00	<b>358.80</b>
565mm	101.0066	335.00	<b>402.00</b>

#### Curved Triple Hanger - Polished Stainless Steel

Size	Code	£ Ex VAT	£ Inc VAT
280mm	101.0057	240.00	<b>288.00</b>
375mm	101.0058	261.00	<b>313.20</b>
470mm	101.0059	299.00	<b>358.80</b>
565mm	101.0067	335.00	<b>402.00</b>

Material: **Stainless Steel - Grade 304**

### TECHNICAL INFORMATION

#### Vertical Radiators:

1800mm height radiators comes with 3 pre-drilled towel hanger locations. 600mm height radiators come with 1 pre-drilled towel hanger location. The flat triple & curved triple towel hangers are only compatible with the Vertical Radiators and can be fitted to the pre-drilled holes on 1800mm & 600mm height radiators. **Can be fitted after installation only on high adjustment bracket fitting.**

#### Horizontal Radiators:

The flat triple & curved triple towel hangers are not suitable for horizontal radiators.

## PERETTI DESIGNER TOWEL HANGERS

### Square Style



#### Square Towel Hanger - Matt White

Size	Code	£ Ex VAT	£ Inc VAT
375mm	101.0075	72.00	<b>86.40</b>
470mm	101.0076	79.00	<b>94.80</b>
565mm	101.0077	92.00	<b>110.40</b>

#### Square Towel Hanger - Matt Anthracite

Size	Code	£ Ex VAT	£ Inc VAT
375mm	101.0078	72.00	<b>86.40</b>
470mm	101.0079	79.00	<b>94.80</b>
565mm	101.0080	92.00	<b>110.40</b>

#### Square Towel Hanger - Matt Black

Size	Code	£ Ex VAT	£ Inc VAT
375mm	101.0081	72.00	<b>86.40</b>
470mm	101.0082	79.00	<b>94.80</b>
565mm	101.0083	92.00	<b>110.40</b>

#### Square Towel Hanger - Chrome

Size	Code	£ Ex VAT	£ Inc VAT
375mm	101.0084	83.00	<b>99.60</b>
470mm	101.0085	96.00	<b>115.20</b>
565mm	101.0086	112.00	<b>134.40</b>

### Triangle Style



#### Triangle Towel Hanger - Matt White

Size	Code	£ Ex VAT	£ Inc VAT
375mm	101.0087	74.00	<b>88.80</b>
470mm	101.0088	83.00	<b>99.60</b>
565mm	101.0089	97.00	<b>116.40</b>

#### Triangle Towel Hanger - Matt Anthracite

Size	Code	£ Ex VAT	£ Inc VAT
375mm	101.0090	74.00	<b>88.80</b>
470mm	101.0091	83.00	<b>99.60</b>
565mm	101.0092	97.00	<b>116.40</b>

#### Triangle Towel Hanger - Matt Black

Size	Code	£ Ex VAT	£ Inc VAT
375mm	101.0093	74.00	<b>88.80</b>
470mm	101.0094	83.00	<b>99.60</b>
565mm	101.0095	97.00	<b>116.40</b>

#### Triangle Towel Hanger - Chrome

Size	Code	£ Ex VAT	£ Inc VAT
375mm	101.0096	84.00	<b>100.80</b>
470mm	101.0097	97.00	<b>116.40</b>
565mm	101.0098	115.00	<b>138.00</b>

### Circle Style



#### Circle Towel Hanger - Matt White

Size	Code	£ Ex VAT	£ Inc VAT
375mm	101.0099	78.00	<b>93.60</b>
470mm	101.0100	86.00	<b>103.20</b>
565mm	101.0101	100.00	<b>120.00</b>

#### Circle Towel Hanger - Matt Anthracite

Size	Code	£ Ex VAT	£ Inc VAT
375mm	101.0102	78.00	<b>93.60</b>
470mm	101.0103	86.00	<b>103.20</b>
565mm	101.0104	100.00	<b>120.00</b>

#### Circle Towel Hanger - Matt Black

Size	Code	£ Ex VAT	£ Inc VAT
375mm	101.0105	78.00	<b>93.60</b>
470mm	101.0106	86.00	<b>103.20</b>
565mm	101.0107	100.00	<b>120.00</b>

#### Circle Towel Hanger - Chrome

Size	Code	£ Ex VAT	£ Inc VAT
375mm	101.0108	84.00	<b>100.80</b>
470mm	101.0109	98.00	<b>117.60</b>
565mm	101.0110	116.00	<b>139.20</b>

Material: **Steel**

### TECHNICAL INFORMATION

Square, Triangle and Circle Towel Hangers are only compatible with vertical radiators and can be fitted to one of the three pre-drilled holes on the 1800mm height radiators. Square, Triangle and Circle Towel Hangers will add approx 8mm width on each side once fitted to the radiator. **Can be fitted after installation only on high adjustment bracket fitting.**

# Aluminium Range

## SANDHURST VERTICAL

Side or Bottom connection options

**Technical Tables  
& Drawings**  
Page 370-371



An aluminium radiator with elliptical vertical panels that will take everyone's attention. Vertical model is available in 3 different colours, 3 width and 1 height options. This radiator is capable of heating up very quickly, thanks to being constructed in aluminium.

### Sandhurst Vertical Aluminium Radiators - Matt White

Size H x W	Watts	BTU	Element Output	Element Type	Code	£ Ex VAT	£ Inc VAT
1800 x 275mm	901	3074	450W	A, A+	86.0270	335.00	402.00
1800 x 415mm	1351	4611	750W	A, A+	86.0271	468.00	561.60
1800 x 485mm	1577	5380	900W	A, A+	86.0272	531.00	637.20

### Sandhurst Vertical Aluminium Radiators - Matt Anthracite

Size H x W	Watts	BTU	Element Output	Element Type	Code	£ Ex VAT	£ Inc VAT
1800 x 275mm	901	3074	450W	A, A+	86.0278	335.00	402.00
1800 x 415mm	1351	4611	750W	A, A+	86.0279	468.00	561.60
1800 x 485mm	1577	5380	900W	A, A+	86.0280	531.00	637.20

### Sandhurst Vertical Aluminium Radiators - Polished Aluminium

Size H x W	Watts	BTU	Element Output	Element Type	Code	£ Ex VAT	£ Inc VAT
1800 x 275mm	901	3074	450W	A, A+	86.0281	377.00	452.40
1800 x 415mm	1351	4611	750W	A, A+	86.0282	525.00	630.00
1800 x 485mm	1577	5380	900W	A, A+	86.0283	599.00	718.80

Prices include radiator and wall fixing sets, valves and accessories extra.

#### FEATURES

- Excellent heat conductivity and lightweight
- Only requires a low water volume
- Heats up very quickly
- Side or bottom connection options
- Radiators come with cover caps on top and bottom, same as radiator colour
- Tested to BS EN 442 standards
- 5 Year Manufacturer's Warranty\*
- Can be single or dual fuel, or all electric
- \* With conditions

#### TECHNICAL INFORMATION

All measurements in Height by Width. Heat output based on  $\Delta T60^{\circ}\text{C}$ . For matching valves see pages 301-309. Corrosion inhibitor must be added to the heating system and maintained. Flow diverter must only be fitted when radiator installed on central heating system. For indirect heating systems only. **Side connection:** Tappings are the width of the rail and approx 65mm off the wall. **Bottom connection:** Tappings are 65mm less than the width of the rail and approx 65mm off the wall.

Warranty

5  
Year

Heating



All Electric



Dual-Fuel



For element types  
see pages 288-300.

Element can be installed vertically on the right-hand side or left-hand side on the bottom header. Radiators that are electric only are restricted to the heat output of the elements. For dual fuel installations, element must be installed on flow side.



### Sandhurst Cover Cap Sets - Chrome

Description	Code	£ Ex VAT	£ Inc VAT
Cover Cap Set 275mm	86.0302	29.00	34.80
Cover Cap Set 415mm	86.0303	38.00	45.60
Cover Cap Set 485mm	86.0304	40.00	48.00

Cover cap sets only include cover caps for the top of the radiator.



Pictured 86.0279 Matt Anthracite with 86.0331 x3 Towel Hangers (side connection valves shown)

# Aluminium Range

## SANDHURST VERTICAL

Technical Tables  
& Drawings  
Page 370-371

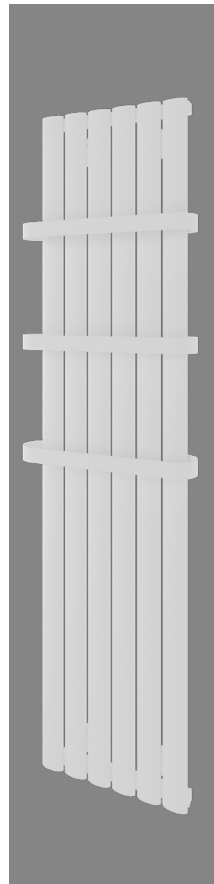

Matt White

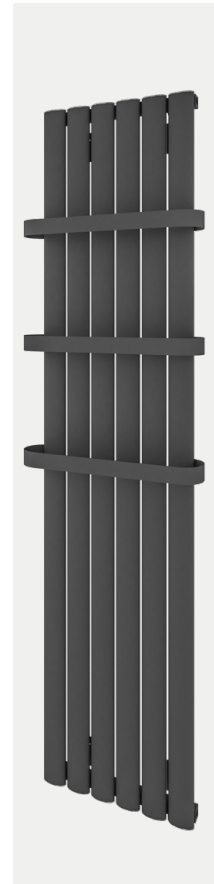

Matt Anthracite



Polished

## SANDHURST - STANDARD TOWEL HANGERS

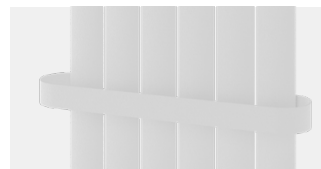

Towel Hanger - Matt White				
Size	Code	£ Ex VAT	£ Inc VAT	
275mm	86.0324	50.00	60.00	
415mm	86.0325	57.00	68.40	
485mm	86.0326	65.00	78.00	



Towel Hanger - Matt Anthracite				
Size	Code	£ Ex VAT	£ Inc VAT	
275mm	86.0327	50.00	60.00	
415mm	86.0328	57.00	68.40	
485mm	86.0329	65.00	78.00	

### TECHNICAL INFORMATION

Material: **Steel**

#### Vertical Radiators:

1800mm height radiators comes with 3 pre-drilled towel hanger locations, with a maximum of 3 towel hangers - all widths; 275, 415 and 485mm. The standard towel hangers are only compatible with the Vertical Radiators. The Sandhurst Standard Towel Hangers will add approx 42mm width on each side once fitted to the radiator.

**Must be fitted before installation!**



Towel Hanger - Chrome				
Size	Code	£ Ex VAT	£ Inc VAT	
275mm	86.0330	50.00	60.00	
415mm	86.0331	57.00	68.40	
485mm	86.0332	65.00	78.00	

Pictured 86.0283 Polished Aluminium with 86.0332 x3 Towel Hangers (bottom connection valves shown)

# Aluminium Range

## SANDHURST HORIZONTAL

Warranty

# 5

Year

Heating



All Electric



Dual-Fuel

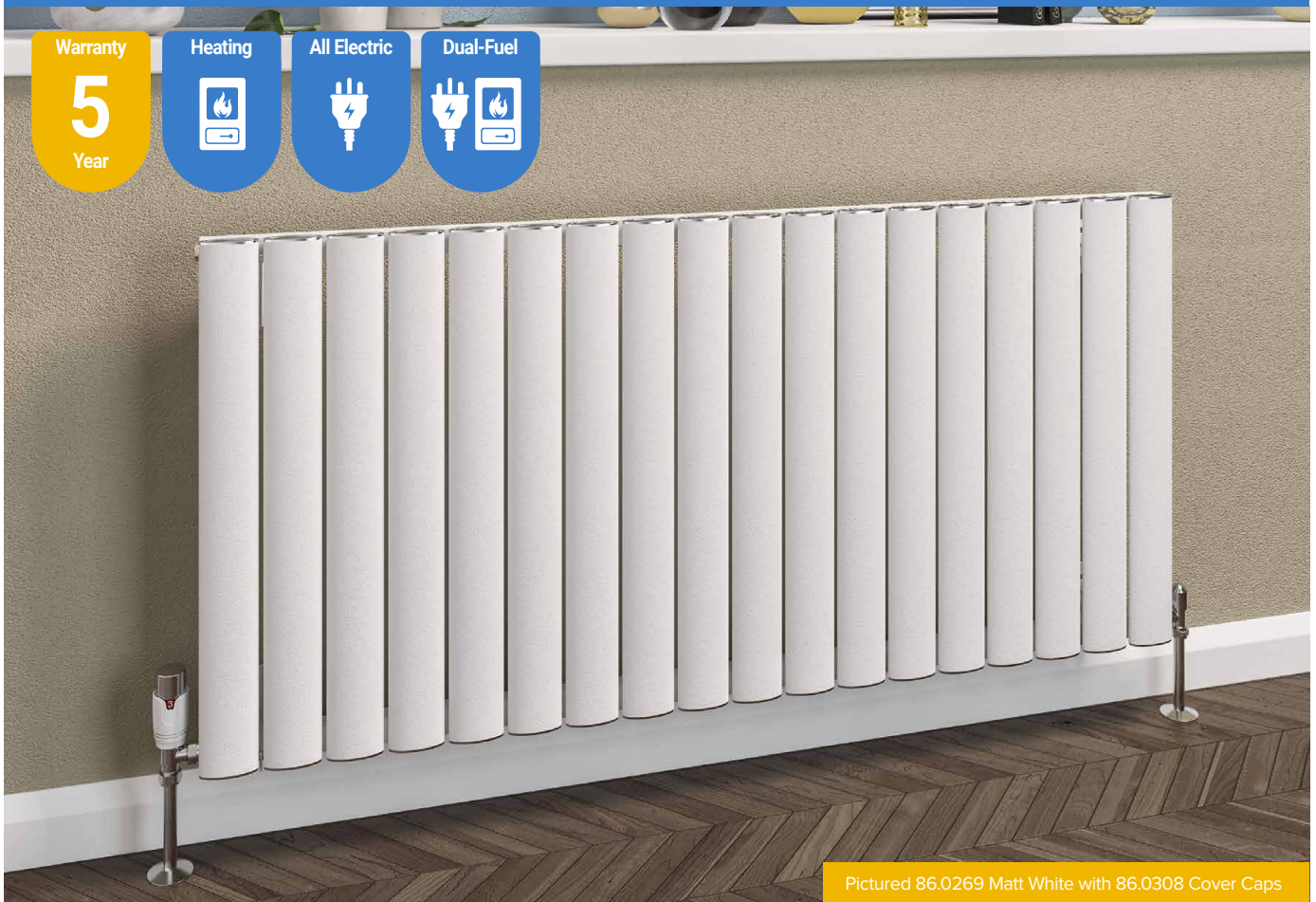

Pictured 86.0269 Matt White with 86.0308 Cover Caps

An aluminium radiator with elliptical vertical panels that will take everyone's attention. Horizontal model is available in 2 different colours, 5 width and 1 Height options. This radiator is capable of heating up very quickly, thanks to being constructed in aluminium.

### Sandhurst Horizontal Aluminium Radiators - Matt White

Size H x W	Watts	BTU	Element Output	Element Type	Code	£ Ex VAT	£ Inc VAT
600 x 485mm	526	1793	300W	A, A+	86.0265	271.00	<b>325.20</b>
600 x 625mm	676	2306	450W	A, A+	86.0266	326.00	<b>391.20</b>
600 x 835mm	901	3074	450W	A, A+	86.0267	410.00	<b>492.00</b>
600 x 1045mm	1126	3843	600W	A, A+	86.0268	493.00	<b>591.60</b>
600 x 1255mm	1351	4611	750W	A, A+	86.0269	580.00	<b>696.00</b>

### Sandhurst Horizontal Aluminium Radiators - Matt Anthracite

Size H x W	Watts	BTU	Element Output	Element Type	Code	£ Ex VAT	£ Inc VAT
600 x 485mm	526	1793	300W	A, A+	86.0273	271.00	<b>325.20</b>
600 x 625mm	676	2306	450W	A, A+	86.0274	326.00	<b>391.20</b>
600 x 835mm	901	3074	450W	A, A+	86.0275	410.00	<b>492.00</b>
600 x 1045mm	1126	3843	600W	A, A+	86.0276	493.00	<b>591.60</b>
600 x 1255mm	1351	4611	750W	A, A+	86.0277	580.00	<b>696.00</b>

Prices include radiator and wall fixing sets, valves and accessories extra.

### FEATURES

- Excellent heat conductivity and lightweight
- Only requires a low water volume
- Heats up very quickly
- Radiators come with cover caps on top and bottom, same as radiator colour
- Tested to BS EN 442 standards
- 5 Year Manufacturer's Warranty\*
- Can be single or dual fuel, or all electric
- \* With conditions

Technical Tables  
& Drawings  
Page 370-371



### Sandhurst Cover Cap Sets - Chrome

Description	Code	£ Ex VAT	£ Inc VAT
Cover Cap Set 485mm	86.0304	40.00	<b>48.00</b>
Cover Cap Set 625mm	86.0305	49.00	<b>58.80</b>
Cover Cap Set 835mm	86.0306	60.00	<b>72.00</b>
Cover Cap Set 1045mm	86.0307	69.00	<b>82.80</b>
Cover Cap Set 1255mm	86.0308	81.00	<b>97.20</b>

Cover cap sets only include cover caps for the top of the radiator.

For element types  
see pages 288-300.

Element can only be installed horizontally on the bottom header. Radiators that are electric only are restricted to the heat output of the elements.



### TOWEL HANGERS

#### Horizontal Radiators:

Horizontal radiators do not have holes for Standard Towel Hangers. Standard Towel Hangers can not be fitted.

### TECHNICAL INFORMATION

All measurements in Height by Width. Heat output based on  $\Delta T60^{\circ}\text{C}$ . For matching valves see pages 301-309. Corrosion inhibitor must be added to the heating system and maintained. Flow diverter must only be fitted when radiator installed on central heating system. For indirect heating systems only. Tappings are the width of the rail and approx. 65mm off the wall.

# Aluminium Range

## BERKELEY

Matt White



Pictured 89.0712 Matt White

Matt Grey



Pictured 89.0722 Matt Grey

Matt Anthracite



Pictured 89.0732 Matt Anthracite

Warranty

5  
Year

Heating



### Berkeley Aluminium Radiator - Matt White

Size H x W	Watts	BTU	Element Output	Element Type	Code	£ Ex VAT	£ Inc VAT
603 x 600mm	425	1451	N/A	N/A	89.0711	150.00	<b>180.00</b>
603 x 800mm	558	1904	N/A	N/A	89.0712	197.00	<b>236.40</b>
603 x 1000mm	690	2355	N/A	N/A	89.0713	247.00	<b>296.40</b>
603 x 1200mm	820	2798	N/A	N/A	89.0714	296.00	<b>355.20</b>
603 x 1400mm	949	3238	N/A	N/A	89.0715	344.00	<b>412.80</b>
603 x 1600mm	1077	3675	N/A	N/A	89.0716	391.00	<b>469.20</b>
603 x 1800mm	1204	4109	N/A	N/A	89.0717	441.00	<b>529.20</b>
603 x 2000mm	1330	4538	N/A	N/A	89.0718	490.00	<b>588.00</b>

### Berkeley Aluminium Radiator - Matt Grey

Size H x W	Watts	BTU	Element Output	Element Type	Code	£ Ex VAT	£ Inc VAT
603 x 600mm	425	1451	N/A	N/A	89.0719	150.00	<b>180.00</b>
603 x 800mm	558	1904	N/A	N/A	89.0720	197.00	<b>236.40</b>
603 x 1000mm	690	2355	N/A	N/A	89.0721	247.00	<b>296.40</b>
603 x 1200mm	820	2798	N/A	N/A	89.0722	296.00	<b>355.20</b>
603 x 1400mm	949	3238	N/A	N/A	89.0723	344.00	<b>412.80</b>
603 x 1600mm	1077	3675	N/A	N/A	89.0724	391.00	<b>469.20</b>
603 x 1800mm	1204	4109	N/A	N/A	89.0725	441.00	<b>529.20</b>
603 x 2000mm	1330	4538	N/A	N/A	89.0726	490.00	<b>588.00</b>

### Berkeley Aluminium Radiator - Matt Anthracite

Size H x W	Watts	BTU	Element Output	Element Type	Code	£ Ex VAT	£ Inc VAT
603 x 600mm	425	1451	N/A	N/A	89.0727	150.00	<b>180.00</b>
603 x 800mm	558	1904	N/A	N/A	89.0728	197.00	<b>236.40</b>
603 x 1000mm	690	2355	N/A	N/A	89.0729	247.00	<b>296.40</b>
603 x 1200mm	820	2798	N/A	N/A	89.0730	296.00	<b>355.20</b>
603 x 1400mm	949	3238	N/A	N/A	89.0731	344.00	<b>412.80</b>
603 x 1600mm	1077	3675	N/A	N/A	89.0732	391.00	<b>469.20</b>
603 x 1800mm	1204	4109	N/A	N/A	89.0733	441.00	<b>529.20</b>
603 x 2000mm	1330	4538	N/A	N/A	89.0734	490.00	<b>588.00</b>

Horizontally positioned sleek and futuristic panels combined to create the radiator that will create an elegant look in every room it will be installed. When you are bored with the standard, old fashioned single panel radiators, just replace with a brand new Berkeley aluminium radiator, the perfect alternative for single panel radiators.

#### FEATURES

- Perfect alternative for Single Panel (Type11) Radiators
  - Only requires a low water volume
  - Heats up very quickly
  - Tested to BS EN 442 standards
  - 5 Year Manufacturer's Warranty\*
  - Not suitable for elements
- \* With conditions

#### Technical Tables & Drawings

Page 370-371

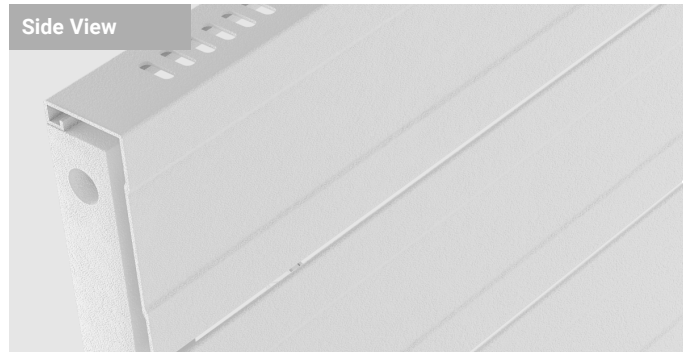

#### TECHNICAL INFORMATION

All measurements in Height by Width. Heat output based on  $\Delta T60^{\circ}\text{C}$ . For matching valves see pages 301-309. Corrosion inhibitor must be added to the heating system and maintained. For indirect heating systems only. Tappings are the width of the rail and approx. 50mm off the wall. Projection from wall 70mm.

# Aluminium Range

## TORDINO VERTICAL



Pictured 89.1208 Matt White with 101.0110 Circle Towel Hanger Chrome

**Round Vent Caps**  
Page 313



Pictured 89.1225 Matt Anthracite with 89.0136 Towel Hangers

An aluminium radiator with front facing curved panels that will add luxury to your desired room, with a choice of towel hangers and your bathroom can also be heated while drying your towels. Available in vertical and horizontal styles and 4 colours options.

### TECHNICAL INFORMATION

All measurements in Height by Width. Heat output based on  $\Delta T60^{\circ}\text{C}$ . For matching valves see pages 301-309. Corrosion inhibitor must be added to the heating system and maintained. Flow diverter must only be fitted when radiator installed on central heating system. For indirect heating systems only. Tappings are the width of the rail and 31 or 51mm off the wall. Projection from wall is 80 or 100mm.

### FEATURES

- Excellent heat conductivity and lightweight
- Only requires a low water volume
- Heats up very quickly
- Radiators come with cover caps on top and bottom, same as radiator colour
- Tested to BS EN 442 standards
- 5 Year Manufacturer's Warranty\*
- Can be single or dual fuel, or all electric
- \* With conditions

**Technical Tables & Drawings**  
Page 370-371



<p>Warranty</p> <p><b>5</b></p> <p>Year</p>	<p>Heating</p>	<p>All Electric</p>	<p>Dual-Fuel</p>
---	----------------	---------------------	------------------

### Radiator Valves

Page 301-309

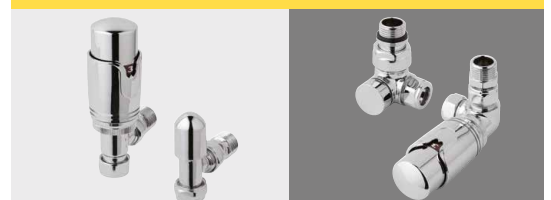



# Aluminium Range

## TORDINO VERTICAL

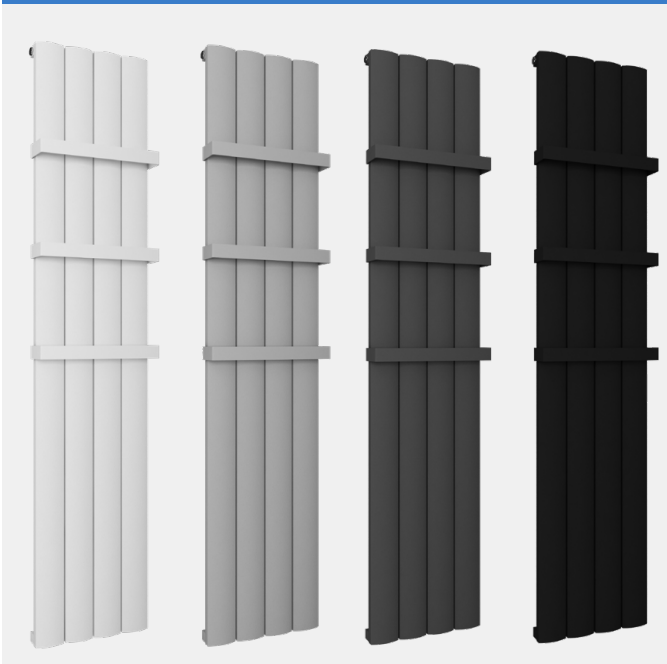

Matt White    Matt Grey    Matt Anthracite    Matt Black

### Tordino Vertical Aluminium Radiators - Matt White

Size H x W	Watts	BTU	Element Output	Element Type	Code	£ Ex VAT	£ Inc VAT
1800 x 280mm	864	2948	450W	A, A+, F, G	89.1205	314.00	<b>376.80</b>
1800 x 375mm	1149	3921	600W	A, A+, F, G	89.1206	403.00	<b>483.60</b>
1800 x 470mm	1432	4886	750W	A, A+, F, G	89.1207	492.00	<b>590.40</b>
1800 x 565mm	1713	5845	1000W	A, A+, F, G	89.1208	590.00	<b>708.00</b>

### Tordino Vertical Aluminium Radiators - Matt Grey

Size H x W	Watts	BTU	Element Output	Element Type	Code	£ Ex VAT	£ Inc VAT
1800 x 280mm	864	2948	450W	A, A+, F, G	89.1214	314.00	<b>376.80</b>
1800 x 375mm	1149	3921	600W	A, A+, F, G	89.1215	403.00	<b>483.60</b>
1800 x 470mm	1432	4886	750W	A, A+, F, G	89.1216	492.00	<b>590.40</b>
1800 x 565mm	1713	5845	1000W	A, A+, F, G	89.1217	590.00	<b>708.00</b>

### Tordino Vertical Aluminium Radiators - Matt Anthracite

Size H x W	Watts	BTU	Element Output	Element Type	Code	£ Ex VAT	£ Inc VAT
1800 x 280mm	864	2948	450W	A, A+, F, G	89.1223	314.00	<b>376.80</b>
1800 x 375mm	1149	3921	600W	A, A+, F, G	89.1224	403.00	<b>483.60</b>
1800 x 470mm	1432	4886	750W	A, A+, F, G	89.1225	492.00	<b>590.40</b>
1800 x 565mm	1713	5845	1000W	A, A+, F, G	89.1226	590.00	<b>708.00</b>

### Tordino Vertical Aluminium Radiators - Matt Black

Size H x W	Watts	BTU	Element Output	Element Type	Code	£ Ex VAT	£ Inc VAT
1800 x 280mm	864	2948	450W	A, A+, F, G	89.1232	314.00	<b>376.80</b>
1800 x 375mm	1149	3921	600W	A, A+, F, G	89.1233	403.00	<b>483.60</b>
1800 x 470mm	1432	4886	750W	A, A+, F, G	89.1234	492.00	<b>590.40</b>
1800 x 565mm	1713	5845	1000W	A, A+, F, G	89.1235	590.00	<b>708.00</b>

Prices include radiator and wall fixing sets, valves and accessories extra.

For all Tordino Matt White, Matt Grey, Matt Anthracite, Matt Black, Chrome and Premium Towel Hangers, please refer to page 225.

For element types see pages 288-300.

Element can only be installed vertically on the right-hand side on the bottom header.

Radiators that are electric only are restricted to the heat output of the elements. Element size can be increased to full capacity of rail if using element type F or G. For dual fuel installations, element must be installed on flow side.



Pictured 89.1215 Matt Grey with 89.0886L Towel Hanger



### Tordino Cover Cap Sets - Chrome

Description	Code	£ Ex VAT	£ Inc VAT
Cover Cap Set 280mm	89.1236	14.00	<b>16.80</b>
Cover Cap Set 375mm	89.1237	16.00	<b>19.20</b>
Cover Cap Set 470mm	89.1238	18.00	<b>21.60</b>
Cover Cap Set 565mm	89.1239	23.00	<b>27.60</b>

Cover cap sets only include cover caps for the top of the radiator.

### Multi-Purpose Towel Hangers

Page 312



# Aluminium Range

## TORDINO HORIZONTAL



Pictured 89.1221 Matt Anthracite



Pictured 89.1212 Matt Grey

### Tordino Horizontal Aluminium Radiators - Matt White

Size H x W	Watts	BTU	Element Output	Element Type	Code	£ Ex VAT	£ Inc VAT
600 x 470mm	520	1775	300W	A, A+, C, H	89.1200	258.00	<b>309.60</b>
600 x 660mm	724	2471	450W	A, A+, C, H	89.1201	339.00	<b>406.80</b>
600 x 850mm	927	3163	600W	A, A+, C, H	89.1202	424.00	<b>508.80</b>
600 x 1040mm	1129	3853	750W	A, A+, C, H	89.1203	502.00	<b>602.40</b>
600 x 1230mm	1329	4535	900W	A, A+, C, H	89.1204	592.00	<b>710.40</b>

### Tordino Horizontal Aluminium Radiators - Matt Grey

Size H x W	Watts	BTU	Element Output	Element Type	Code	£ Ex VAT	£ Inc VAT
600 x 470mm	520	1775	300W	A, A+, C, H	89.1209	258.00	<b>309.60</b>
600 x 660mm	724	2471	450W	A, A+, C, H	89.1210	339.00	<b>406.80</b>
600 x 850mm	927	3163	600W	A, A+, C, H	89.1211	424.00	<b>508.80</b>
600 x 1040mm	1129	3853	750W	A, A+, C, H	89.1212	502.00	<b>602.40</b>
600 x 1230mm	1329	4535	900W	A, A+, C, H	89.1213	592.00	<b>710.40</b>

### Tordino Horizontal Aluminium Radiators - Matt Anthracite

Size H x W	Watts	BTU	Element Output	Element Type	Code	£ Ex VAT	£ Inc VAT
600 x 470mm	520	1775	300W	A, A+, C, H	89.1218	258.00	<b>309.60</b>
600 x 660mm	724	2471	450W	A, A+, C, H	89.1219	339.00	<b>406.80</b>
600 x 850mm	927	3163	600W	A, A+, C, H	89.1220	424.00	<b>508.80</b>
600 x 1040mm	1129	3853	750W	A, A+, C, H	89.1221	502.00	<b>602.40</b>
600 x 1230mm	1329	4535	900W	A, A+, C, H	89.1222	592.00	<b>710.40</b>

### Tordino Horizontal Aluminium Radiators - Matt Black

Size H x W	Watts	BTU	Element Output	Element Type	Code	£ Ex VAT	£ Inc VAT
600 x 470mm	520	1775	300W	A, A+, C, H	89.1227	258.00	<b>309.60</b>
600 x 660mm	724	2471	450W	A, A+, C, H	89.1228	339.00	<b>406.80</b>
600 x 850mm	927	3163	600W	A, A+, C, H	89.1229	424.00	<b>508.80</b>
600 x 1040mm	1129	3853	750W	A, A+, C, H	89.1230	502.00	<b>602.40</b>
600 x 1230mm	1329	4535	900W	A, A+, C, H	89.1231	592.00	<b>710.40</b>

Prices include radiator and wall fixing sets, valves and accessories extra.

For element types see pages 288-300.

Element can only be installed horizontally on the bottom header. Radiators that are electric only are restricted to the heat output of the elements. (Type C&H up to 900 Watts)



#### Warranty

5  
Year

#### Heating



#### All Electric



#### Dual-Fuel



#### FEATURES

- Excellent heat conductivity and lightweight
  - Only requires a low water volume
  - Heats up very quickly
  - Radiators come with cover caps on top and bottom, same as radiator colour
  - Tested to BS EN 442 standards
  - 5 Year Manufacturer's Warranty\*
  - Can be single or dual fuel, or all electric
- \* With conditions

#### Technical Tables & Drawings

Page 372-373



#### TECHNICAL INFORMATION

All measurements in Height by Width. Heat output based on  $\Delta T60^{\circ}\text{C}$ . For matching valves see pages 301-309. Corrosion inhibitor must be added to the heating system and maintained. Flow diverter must only be fitted when radiator installed on central heating system. For indirect heating systems only. Tappings are the width of the rail and 31 or 51mm off the wall. Projection from wall is 80 or 100mm.



#### Tordino Cover Cap Sets - Chrome

Description	Code	£ Ex VAT	£ Inc VAT
Cover Cap Set 470mm	89.1238	18.00	<b>21.60</b>
Cover Cap Set 660mm	89.1240	28.00	<b>33.60</b>
Cover Cap Set 850mm	89.1241	34.00	<b>40.80</b>
Cover Cap Set 1040mm	89.1242	41.00	<b>49.20</b>
Cover Cap Set 1230mm	89.1243	47.00	<b>56.40</b>

Cover cap sets only include cover caps for the top of the radiator.

#### Round Vent Caps

Page 313



# Aluminium Range

## TORDINO STANDARD TOWEL HANGERS



Towel Hanger - Matt White			
Size	Code	£ Ex VAT	£ Inc VAT
280mm	89.0177	62.00	<b>74.40</b>
375mm	89.0178	66.00	<b>79.20</b>
470mm	89.0179	74.00	<b>88.80</b>
565mm	86.0333	78.00	<b>93.60</b>



Towel Hanger - Matt Anthracite			
Size	Code	£ Ex VAT	£ Inc VAT
280mm	89.0180	62.00	<b>74.40</b>
375mm	89.0181	66.00	<b>79.20</b>
470mm	89.0182	74.00	<b>88.80</b>
565mm	86.0334	78.00	<b>93.60</b>

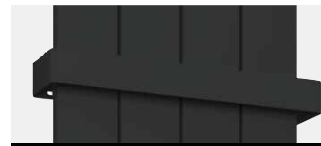

Towel Hanger - Matt Black			
Size	Code	£ Ex VAT	£ Inc VAT
280mm	89.0183	62.00	<b>74.40</b>
375mm	89.0184	66.00	<b>79.20</b>
470mm	89.0185	74.00	<b>88.80</b>
565mm	86.0335	78.00	<b>93.60</b>



Towel Hanger - Chrome			
Size	Code	£ Ex VAT	£ Inc VAT
280mm	89.0134	53.00	<b>63.60</b>
375mm	89.0135	56.00	<b>67.20</b>
470mm	89.0136	65.00	<b>78.00</b>
565mm	86.0336	72.00	<b>86.40</b>

### TECHNICAL INFORMATION

**Material:** Steel (Premium: Stainless Steel - Grade 304)

#### Vertical Radiators:

1800mm height radiators comes with 3 pre-drilled towel hanger locations, with a maximum of 3 towel hangers - all widths; 280, 375, 470 and 565mm. The standard towel hangers are only compatible with the Vertical Radiators.

**Can be fitted after installation only on high adjustment bracket fitting.**

#### Horizontal Radiators:

Don't have holes for Standard Towel Hangers. Standard Towel Hanger can not be fitted. The Tordino Standard Towel Hangers will add approx 8mm width on each side once fitted to the radiator.



Towel Hanger - Matt Grey			
Size	Code	£ Ex VAT	£ Inc VAT
280mm	89.1616	62.00	<b>74.40</b>
375mm	89.1617	66.00	<b>79.20</b>
470mm	89.1618	74.00	<b>88.80</b>
565mm	89.1619	78.00	<b>93.60</b>



Towel Hanger - Mirror Polished Premium			
Size	Code	£ Ex VAT	£ Inc VAT
280mm	86.0198	73.00	<b>87.60</b>
375mm	86.0199	80.00	<b>96.00</b>
470mm	86.0200	87.00	<b>104.40</b>
565mm	86.0337	93.00	<b>111.60</b>

## TORDINO DESIGNER TOWEL HANGERS

### Square Style



Square Towel Hanger - Matt White			
Size	Code	£ Ex VAT	£ Inc VAT
375mm	101.0075	72.00	<b>86.40</b>
470mm	101.0076	79.00	<b>94.80</b>
565mm	101.0077	92.00	<b>110.40</b>

Square Towel Hanger - Matt Anthracite			
Size	Code	£ Ex VAT	£ Inc VAT
375mm	101.0078	72.00	<b>86.40</b>
470mm	101.0079	79.00	<b>94.80</b>
565mm	101.0080	92.00	<b>110.40</b>

Square Towel Hanger - Matt Black			
Size	Code	£ Ex VAT	£ Inc VAT
375mm	101.0081	72.00	<b>86.40</b>
470mm	101.0082	79.00	<b>94.80</b>
565mm	101.0083	92.00	<b>110.40</b>

Square Towel Hanger - Chrome			
Size	Code	£ Ex VAT	£ Inc VAT
375mm	101.0084	83.00	<b>99.60</b>
470mm	101.0085	96.00	<b>115.20</b>
565mm	101.0086	112.00	<b>134.40</b>

### Triangle Style



Triangle Towel Hanger - Matt White			
Size	Code	£ Ex VAT	£ Inc VAT
375mm	101.0087	74.00	<b>88.80</b>
470mm	101.0088	83.00	<b>99.60</b>
565mm	101.0089	97.00	<b>116.40</b>

Triangle Towel Hanger - Matt Anthracite			
Size	Code	£ Ex VAT	£ Inc VAT
375mm	101.0090	74.00	<b>88.80</b>
470mm	101.0091	83.00	<b>99.60</b>
565mm	101.0092	97.00	<b>116.40</b>

Triangle Towel Hanger - Matt Black			
Size	Code	£ Ex VAT	£ Inc VAT
375mm	101.0093	74.00	<b>88.80</b>
470mm	101.0094	83.00	<b>99.60</b>
565mm	101.0095	97.00	<b>116.40</b>

Triangle Towel Hanger - Chrome			
Size	Code	£ Ex VAT	£ Inc VAT
375mm	101.0096	84.00	<b>100.80</b>
470mm	101.0097	97.00	<b>116.40</b>
565mm	101.0098	115.00	<b>138.00</b>

### Circle Style



Circle Towel Hanger - Matt White			
Size	Code	£ Ex VAT	£ Inc VAT
375mm	101.0099	78.00	<b>93.60</b>
470mm	101.0100	86.00	<b>103.20</b>
565mm	101.0101	100.00	<b>120.00</b>

Circle Towel Hanger - Matt Anthracite			
Size	Code	£ Ex VAT	£ Inc VAT
375mm	101.0102	78.00	<b>93.60</b>
470mm	101.0103	86.00	<b>103.20</b>
565mm	101.0104	100.00	<b>120.00</b>

Circle Towel Hanger - Matt Black			
Size	Code	£ Ex VAT	£ Inc VAT
375mm	101.0105	78.00	<b>93.60</b>
470mm	101.0106	86.00	<b>103.20</b>
565mm	101.0107	100.00	<b>120.00</b>

Circle Towel Hanger - Chrome			
Size	Code	£ Ex VAT	£ Inc VAT
375mm	101.0108	84.00	<b>100.80</b>
470mm	101.0109	98.00	<b>117.60</b>
565mm	101.0110	116.00	<b>139.20</b>

### TECHNICAL INFORMATION

**Material:** Steel

Square, Triangle and Circle Towel Hangers are only compatible with vertical radiators and can be fitted to one of the three pre-drilled holes on the 1800mm height radiators. Square, Triangle and Circle Towel Hangers will add approx 8mm width on each side once fitted to the radiator. **Can be fitted after installation only on high adjustment bracket fitting.**

# Aluminium Range

## GUARDIA VERTICAL

High Output



Pictured 86.0032 Matt White with 86.0239 Towel Hanger

A versatile designer radiator which can be fitted to show the flat side or the curved profile of the panels, allowing the radiator to fit into your lifestyle and decor. Available in horizontal and vertical designs this radiator heats up quickly to warm your whole room.

### Guardia Vertical Aluminium Radiators - Matt White

Size H x W	Watts	BTU	Element Output	Element Type	Code	£ Ex VAT	£ Inc VAT
1200 x 280mm	960	3276	N/A	N/A	86.0446	416.00	499.20
1200 x 375mm	1280	4367	N/A	N/A	86.0449	539.00	646.80
1200 x 470mm	1600	5459	N/A	N/A	86.0452	658.00	789.60
1200 x 565mm	1920	6551	N/A	N/A	86.0455	781.00	937.20
1800 x 280mm	1368	4668	N/A	N/A	86.0029	524.00	628.80
1800 x 375mm	1824	6224	N/A	N/A	86.0032	679.00	814.80
1800 x 470mm	2280	7780	N/A	N/A	86.0035	832.00	998.40
1800 x 565mm	2736	9335	N/A	N/A	86.0291	1013.00	1215.60

### Guardia Vertical Aluminium Radiators - Matt Grey

Size H x W	Watts	BTU	Element Output	Element Type	Code	£ Ex VAT	£ Inc VAT
1200 x 280mm	960	3276	N/A	N/A	86.0482	416.00	499.20
1200 x 375mm	1280	4367	N/A	N/A	86.0483	539.00	646.80
1200 x 470mm	1600	5459	N/A	N/A	86.0484	658.00	789.60
1200 x 565mm	1920	6551	N/A	N/A	86.0485	781.00	937.20
1800 x 280mm	1368	4668	N/A	N/A	86.0189	524.00	628.80
1800 x 375mm	1824	6224	N/A	N/A	86.0190	679.00	814.80
1800 x 470mm	2280	7780	N/A	N/A	86.0191	832.00	998.40
1800 x 565mm	2736	9335	N/A	N/A	86.0292	1013.00	1215.60

### Guardia Vertical Aluminium Radiators - Matt Anthracite

Size H x W	Watts	BTU	Element Output	Element Type	Code	£ Ex VAT	£ Inc VAT
1200 x 280mm	960	3276	N/A	N/A	86.0447	416.00	499.20
1200 x 375mm	1280	4367	N/A	N/A	86.0450	539.00	646.80
1200 x 470mm	1600	5459	N/A	N/A	86.0453	658.00	789.60
1200 x 565mm	1920	6551	N/A	N/A	86.0456	781.00	937.20
1800 x 280mm	1368	4668	N/A	N/A	86.0030	524.00	628.80
1800 x 375mm	1824	6224	N/A	N/A	86.0033	679.00	814.80
1800 x 470mm	2280	7780	N/A	N/A	86.0036	832.00	998.40
1800 x 565mm	2736	9335	N/A	N/A	86.0293	1013.00	1215.60

### Guardia Vertical Aluminium Radiators - Matt Black

Size H x W	Watts	BTU	Element Output	Element Type	Code	£ Ex VAT	£ Inc VAT
1200 x 280mm	960	3276	N/A	N/A	86.0448	416.00	499.20
1200 x 375mm	1280	4367	N/A	N/A	86.0451	539.00	646.80
1200 x 470mm	1600	5459	N/A	N/A	86.0454	658.00	789.60
1200 x 565mm	1920	6551	N/A	N/A	86.0457	781.00	937.20
1800 x 280mm	1368	4668	N/A	N/A	86.0031	524.00	628.80
1800 x 375mm	1824	6224	N/A	N/A	86.0034	679.00	814.80
1800 x 470mm	2280	7780	N/A	N/A	86.0037	832.00	998.40
1800 x 565mm	2736	9335	N/A	N/A	86.0294	1013.00	1215.60

Warranty

5

Year

Heating



Technical Tables  
& Drawings  
Page 372-373



### Guardia Cover Cap Sets - Chrome

Description	Code	£ Ex VAT	£ Inc VAT
Cover Cap Set 280mm	86.0118	29.00	34.80
Cover Cap Set 375mm	86.0119	38.00	45.60
Cover Cap Set 470mm	86.0120	41.00	49.20
Cover Cap Set 565mm	86.0311	79.00	94.80

Cover cap sets only include cover caps for the top of the radiator.

# Aluminium Range

## GUARDIA VERTICAL

### FEATURES

- Can be reversed when hanging on the wall
  - Excellent heat conductivity and lightweight
  - Only requires a low water volume
  - Heats up very quickly
  - Radiators come with cover caps on top and bottom, same as radiator colour
  - Tested to BS EN 442 standards
  - 5 Year Manufacturer's Warranty\*
  - Not suitable for elements
- \* With conditions

### TECHNICAL INFORMATION

All measurements in Height by Width. Heat output based on  $\Delta T60^{\circ}C$ . For matching valves see pages 301-309. Corrosion inhibitor must be added to the heating system and maintained. Flow diverter must only be fitted when radiator installed on central heating system. For indirect heating systems only. Tappings are the width of the rail and approx. 65mm off the wall.

Can be reversed when hanging on the wall. Either side can be used as front facing.

Flat Side

Curved Side



Matt White

Matt Grey

Matt Anthracite

Matt Black

## GUARDIA - WALL MOUNTED TOWEL HANGERS



Towel Hanger - Matt White			
Size	Code	£ Ex VAT	£ Inc VAT
280mm	86.0226	83.00	<b>99.60</b>
375mm	86.0227	92.00	<b>110.40</b>
470mm	86.0228	98.00	<b>117.60</b>
565mm	86.0343	109.00	<b>130.80</b>



Towel Hanger - Matt Grey			
Size	Code	£ Ex VAT	£ Inc VAT
280mm	86.0229	83.00	<b>99.60</b>
375mm	86.0230	92.00	<b>110.40</b>
470mm	86.0231	98.00	<b>117.60</b>
565mm	86.0344	109.00	<b>130.80</b>



Towel Hanger - Matt Anthracite			
Size	Code	£ Ex VAT	£ Inc VAT
280mm	86.0232	83.00	<b>99.60</b>
375mm	86.0233	92.00	<b>110.40</b>
470mm	86.0234	98.00	<b>117.60</b>
565mm	86.0345	109.00	<b>130.80</b>



Towel Hanger - Matt Black			
Size	Code	£ Ex VAT	£ Inc VAT
280mm	86.0235	83.00	<b>99.60</b>
375mm	86.0236	92.00	<b>110.40</b>
470mm	86.0237	98.00	<b>117.60</b>
565mm	86.0346	109.00	<b>130.80</b>

### TECHNICAL INFORMATION

Material: **Steel**

#### Vertical Radiators:

- Guardia Towel Hangers must be mounted on the wall. Can be fitted on both flat and curved type of installation.
- Guardia Towel Hangers can be mounted Left Hand or Right Hand of the radiator. Once the towel hanger is mounted on the wall, the radiator must be fitted from the side.
- Total length of each towel hanger is 30mm longer than the width of the radiator, making the radiator's width +30mm on the side they are mounted on. Towel hangers can be mounted at any height vertically on the wall.

**Must be fitted before radiator installation!**

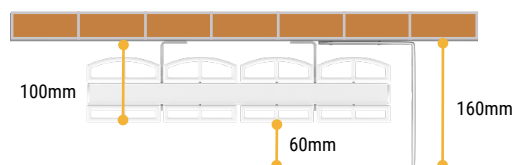
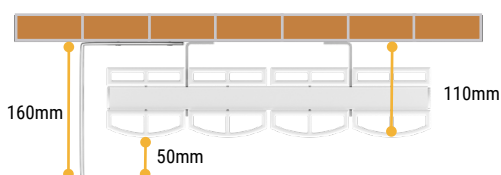

Towel Hanger - Chrome			
Size	Code	£ Ex VAT	£ Inc VAT
280mm	86.0238	87.00	<b>104.40</b>
375mm	86.0239	96.00	<b>115.20</b>
470mm	86.0240	111.00	<b>133.20</b>
565mm	86.0347	118.00	<b>141.60</b>

# Aluminium Range

## GUARDIA HORIZONTAL

Warranty  
**5**  
Year

Heating

All Electric

Dual-Fuel



Curved Side

Pictured 86.0045 Matt Anthracite with Chrome Cover Caps 86.0122 (x2)



Flat Side

Pictured 86.0194 Matt Grey with Chrome Cover Caps 86.0122 (x2)



### Guardia Cover Cap Sets - Chrome

Description	Code	£ Ex VAT	£ Inc VAT
Cover Cap Set 470mm	86.0120	41.00	<b>49.20</b>
Cover Cap Set 660mm	86.0121	55.00	<b>66.00</b>
Cover Cap Set 850mm	86.0122	70.00	<b>84.00</b>
Cover Cap Set 1040mm	86.0123	83.00	<b>99.60</b>
Cover Cap Set 1230mm	86.0124	96.00	<b>115.20</b>
Cover Cap Set 1420mm	86.0175	104.00	<b>124.80</b>

Cover cap sets only include cover caps for the top of the radiator.

For element types see pages 288-300.

Element can only be installed horizontally on the bottom header. When ordering fluid filled rails with elements, please specify the front facing side. The element will be fitted on the right hand side as standard.

Radiators that are electric only are restricted to the heat output of the elements (Type C&H up to 900 watts).



Curved Side

Flat Side

# Aluminium Range

## GUARDIA HORIZONTAL

A versatile designer radiator which can be fitted to show the flat panel side or the curved style of the panels, allowing the radiator to fit into your lifestyle and decor. Available in horizontal and vertical designs this radiator heats up quickly to warm your whole room.

### Guardia Horizontal Aluminium Radiators - Matt White

Size H x W	Watts	BTU	Element Output	Element Type	Code	£ Ex VAT	£ Inc VAT
600 x 470mm	800	2730	450W	A, A+, C, H	86.0038	373.00	447.60
600 x 660mm	1120	3822	600W	A, A+, C, H	86.0041	497.00	596.40
600 x 850mm	1440	4913	750W	A, A+, C, H	86.0044	623.00	747.60
600 x 1040mm	1790	6005	1000W	A, A+, H	86.0047	747.00	896.40
600 x 1230mm	2080	7097	1200W	A, A+	86.0050	873.00	1047.60
600 x 1420mm	2400	8190	1200W	A, A+	86.0170	1020.00	1224.00

### Guardia Horizontal Aluminium Radiators - Matt Grey

Size H x W	Watts	BTU	Element Output	Element Type	Code	£ Ex VAT	£ Inc VAT
600 x 470mm	800	2730	450W	A, A+, C, H	86.0192	373.00	447.60
600 x 660mm	1120	3822	600W	A, A+, C, H	86.0193	497.00	596.40
600 x 850mm	1440	4913	750W	A, A+, C, H	86.0194	623.00	747.60
600 x 1040mm	1790	6005	1000W	A, A+, H	86.0195	747.00	896.40
600 x 1230mm	2080	7097	1200W	A, A+	86.0196	873.00	1047.60
600 x 1420mm	2400	8190	1200W	A, A+	86.0197	1020.00	1224.00

### Guardia Horizontal Aluminium Radiators - Matt Anthracite

Size H x W	Watts	BTU	Element Output	Element Type	Code	£ Ex VAT	£ Inc VAT
600 x 470mm	800	2730	450W	A, A+, C, H	86.0039	373.00	447.60
600 x 660mm	1120	3822	600W	A, A+, C, H	86.0042	497.00	596.40
600 x 850mm	1440	4913	750W	A, A+, C, H	86.0045	623.00	747.60
600 x 1040mm	1790	6005	1000W	A, A+, H	86.0048	747.00	896.40
600 x 1230mm	2080	7097	1200W	A, A+	86.0051	873.00	1047.60
600 x 1420mm	2400	8190	1200W	A, A+	86.0171	1020.00	1224.00

### Guardia Horizontal Aluminium Radiators - Matt Black

Size H x W	Watts	BTU	Element Output	Element Type	Code	£ Ex VAT	£ Inc VAT
600 x 470mm	800	2730	450W	A, A+, C, H	86.0040	373.00	447.60
600 x 660mm	1120	3822	600W	A, A+, C, H	86.0043	497.00	596.40
600 x 850mm	1440	4913	750W	A, A+, C, H	86.0046	623.00	747.60
600 x 1040mm	1790	6005	1000W	A, A+, H	86.0049	747.00	896.40
600 x 1230mm	2080	7097	1200W	A, A+	86.0052	873.00	1047.60
600 x 1420mm	2400	8190	1200W	A, A+	86.0172	1020.00	1224.00

### FEATURES

- Can be reversed when hanging on the wall
  - Excellent heat conductivity and lightweight
  - Only requires a low water volume
  - Heats up very quickly
  - Radiators come with cover caps on top and bottom, same as radiator colour
  - Tested to BS EN 442 standards
  - 5 Year Manufacturer's Warranty\*
- \* With conditions

### Technical Tables & Drawings

Page 372-373



### TECHNICAL INFORMATION

All measurements in Height by Width. Heat output based on  $\Delta T60^{\circ}\text{C}$ . For matching valves see pages 301-309. Corrosion inhibitor must be added to the heating system and maintained. Flow diverter must only be fitted when radiator installed on central heating system. For indirect heating systems only. Tappings are the width of the rail and approx. 65mm off the wall.

### Matt White

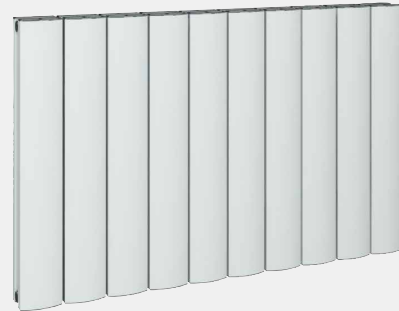

### Matt Grey

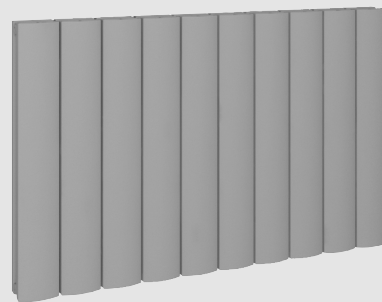

### Matt Anthracite

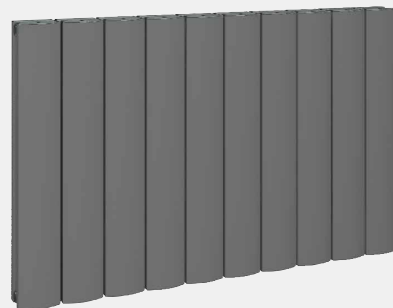

### Matt Black

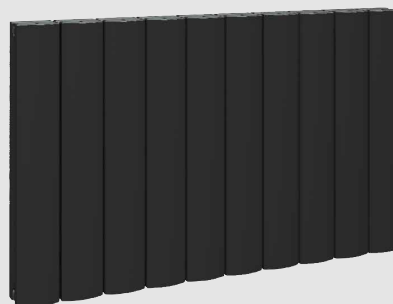

Can be reversed when hanging on the wall. Either side can be used as front facing.

Flat Side >>



Curved Side >>



### Radiator Valves

Page 301-309



# Aluminium Range

## HADLEIGH VERTICAL

High Output



Pictured 86.0247 Matt White with 86.0322 Towel Hanger

A versatile aluminium radiator with double profile construction panels that allows the radiator to produce high heat outputs. This radiator will fit into your lifestyle. Vertical version is available in 3 colours, 2 heights and 4 different widths.

### Hadleigh Vertical Aluminium Radiators - Matt White

Size H x W	Watts	BTU	Element Output	Element Type	Code	£ Ex VAT	£ Inc VAT
1200 x 275mm	779	2658	N/A	N/A	86.0461	396.00	<b>475.20</b>
1200 x 415mm	1169	3987	N/A	N/A	86.0464	564.00	<b>676.80</b>
1200 x 485mm	1363	4652	N/A	N/A	86.0467	649.00	<b>778.80</b>
1200 x 555mm	1558	5316	N/A	N/A	86.0470	733.00	<b>879.60</b>
1800 x 275mm	1003	3422	N/A	N/A	86.0246	469.00	<b>562.80</b>
1800 x 415mm	1504	5132	N/A	N/A	86.0247	666.00	<b>799.20</b>
1800 x 485mm	1755	5988	N/A	N/A	86.0248	766.00	<b>919.20</b>
1800 x 555mm	2006	6843	N/A	N/A	86.0458	934.00	<b>1120.80</b>

### Hadleigh Vertical Aluminium Radiators - Matt Anthracite

Size H x W	Watts	BTU	Element Output	Element Type	Code	£ Ex VAT	£ Inc VAT
1200 x 275mm	779	2658	N/A	N/A	86.0462	396.00	<b>475.20</b>
1200 x 415mm	1169	3987	N/A	N/A	86.0465	564.00	<b>676.80</b>
1200 x 485mm	1363	4652	N/A	N/A	86.0468	649.00	<b>778.80</b>
1200 x 555mm	1558	5316	N/A	N/A	86.0471	733.00	<b>879.60</b>
1800 x 275mm	1003	3422	N/A	N/A	86.0254	469.00	<b>562.80</b>
1800 x 415mm	1504	5132	N/A	N/A	86.0255	666.00	<b>799.20</b>
1800 x 485mm	1755	5988	N/A	N/A	86.0256	766.00	<b>919.20</b>
1800 x 555mm	2006	6843	N/A	N/A	86.0459	934.00	<b>1120.80</b>

### Hadleigh Vertical Aluminium Radiators - Matt Black

Size H x W	Watts	BTU	Element Output	Element Type	Code	£ Ex VAT	£ Inc VAT
1200 x 275mm	779	2658	N/A	N/A	86.0463	396.00	<b>475.20</b>
1200 x 415mm	1169	3987	N/A	N/A	86.0466	564.00	<b>676.80</b>
1200 x 485mm	1363	4652	N/A	N/A	86.0469	649.00	<b>778.80</b>
1200 x 555mm	1558	5316	N/A	N/A	86.0472	733.00	<b>879.60</b>
1800 x 275mm	1003	3422	N/A	N/A	86.0262	469.00	<b>562.80</b>
1800 x 415mm	1504	5132	N/A	N/A	86.0263	666.00	<b>799.20</b>
1800 x 485mm	1755	5988	N/A	N/A	86.0264	766.00	<b>919.20</b>
1800 x 555mm	2006	6843	N/A	N/A	86.0460	934.00	<b>1120.80</b>

### FEATURES

- Special double profile construction for high heat output
- Excellent heat conductivity and lightweight
- Only requires a low water volume
- Heats up very quickly
- Radiators come with cover caps on top and bottom, same as radiator colour
- Tested to BS EN 442 standards
- Not suitable for elements
- 5 Year Manufacturer's Warranty\*
- \* With conditions

### Technical Tables & Drawings

Page 372-373



### TECHNICAL INFORMATION

All measurements in Height by Width. Heat output based on  $\Delta T60^{\circ}\text{C}$ . For matching valves see pages 301-309. Corrosion inhibitor must be added to the heating system and maintained. Flow diverter must only be fitted when radiator installed on central heating system. For indirect heating systems only. Tappings are the width of the rail and approx. 65mm off the wall.



### Hadleigh Cover Cap Sets - Chrome

Description	Code	£ Ex VAT	£ Inc VAT
Cover Cap Set 275mm	86.0295	42.00	<b>50.40</b>
Cover Cap Set 415mm	86.0296	60.00	<b>72.00</b>
Cover Cap Set 485mm	86.0297	67.00	<b>80.40</b>
Cover Cap Set 555mm	86.0488	79.00	<b>94.80</b>

Cover cap sets only include cover caps for the top or bottom of the radiator.



# Aluminium Range

## HADLEIGH VERTICAL



Pictured 86.0468 Matt Anthracite

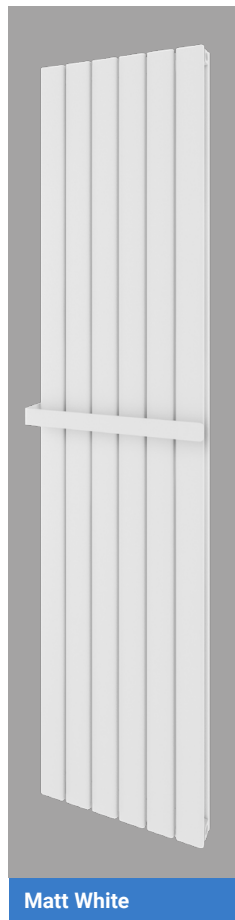

Matt White

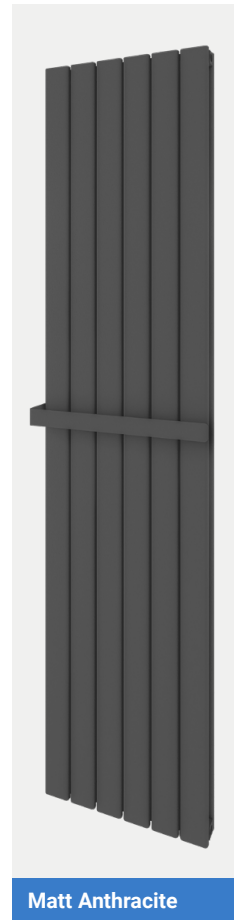

Matt Anthracite



Matt Black

## HADLEIGH - WALL MOUNTED TOWEL HANGERS



Towel Hanger - Matt White			
Size	Code	£ Ex VAT	£ Inc VAT
275mm	86.0312	81.00	<b>97.20</b>
415mm	86.0313	90.00	<b>108.00</b>
485mm	86.0314	98.00	<b>117.60</b>
555mm	86.0490	113.00	<b>135.60</b>

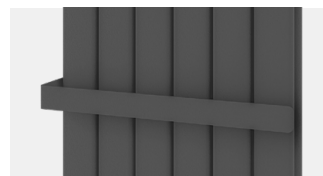

Towel Hanger - Matt Anthracite			
Size	Code	£ Ex VAT	£ Inc VAT
275mm	86.0315	81.00	<b>97.20</b>
415mm	86.0316	90.00	<b>108.00</b>
485mm	86.0317	98.00	<b>117.60</b>
555mm	86.0491	113.00	<b>135.60</b>

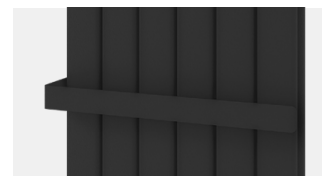

Towel Hanger - Matt Black			
Size	Code	£ Ex VAT	£ Inc VAT
275mm	86.0318	81.00	<b>97.20</b>
415mm	86.0319	90.00	<b>108.00</b>
485mm	86.0320	98.00	<b>117.60</b>
555mm	86.0492	113.00	<b>135.60</b>



Towel Hanger - Chrome			
Size	Code	£ Ex VAT	£ Inc VAT
275mm	86.0321	87.00	<b>104.40</b>
415mm	86.0322	95.00	<b>114.00</b>
485mm	86.0323	110.00	<b>132.00</b>
555mm	86.0493	125.00	<b>150.00</b>

### TECHNICAL INFORMATION

Material: **Steel**

#### Vertical Radiators:

- Hadleigh Towel Hangers must be mounted on the wall.
- Hadleigh Towel Hangers can be mounted Left Hand or Right Hand of the radiator. Once the towel hanger is mounted on the wall, the radiator must be fitted from the side.
- Total length of each towel hanger is 30mm longer than the width of the radiator, making the radiator's width +30mm on the side they are mounted on. Towel hangers can be mounted at any height vertically on the wall.

**Must be fitted before radiator installation!**

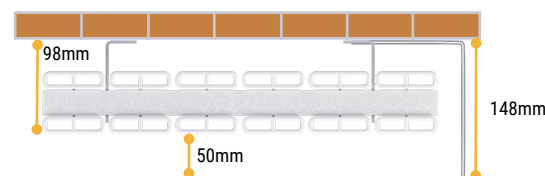
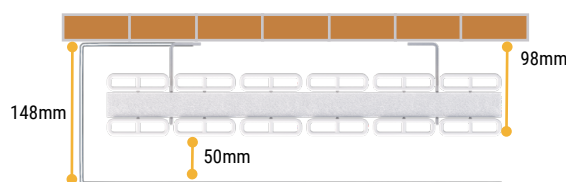

### Radiator Valves

Page 301-309



# Aluminium Range

## HADLEIGH HORIZONTAL

Warranty  
**5**  
Year

Heating

All Electric

Dual-Fuel



Pictured 86.0243 Matt White



Technical Tables  
& Drawings  
Page 374-375

Pictured 86.0252 Matt Anthracite with 86.0300 x2 Cover Caps Chrome

# Aluminium Range

## HADLEIGH HORIZONTAL

A versatile aluminium radiator with double profile construction panels that allows the radiator to produce high heat outputs. This radiator will fit into your lifestyle. Horizontal version is available in 3 colours, 1 height and 6 different widths.

### Hadleigh Horizontal Aluminium Radiators - Matt White

Size H x W	Watts	BTU	Element Output	Element Type	Code	£ Ex VAT	£ Inc VAT
600 x 485mm	821	2801	450W	A, A+, C, H	86.0241	346.00	<b>415.20</b>
600 x 625mm	1055	3601	600W	A, A+, C, H	86.0242	426.00	<b>511.20</b>
600 x 835mm	1407	4802	750W	A, A+, C, H	86.0243	543.00	<b>651.60</b>
600 x 1045mm	1759	6002	1000W	A, A+, C, H	86.0244	663.00	<b>795.60</b>
600 x 1255mm	2111	7202	1200W	A, A+, C, H	86.0245	782.00	<b>938.40</b>
600 x 1395mm	2345	8003	1200W	A, A+, C, H	86.0473	939.00	<b>1126.80</b>

### Hadleigh Horizontal Aluminium Radiators - Matt Anthracite

Size H x W	Watts	BTU	Element Output	Element Type	Code	£ Ex VAT	£ Inc VAT
600 x 485mm	821	2801	450W	A, A+, C, H	86.0249	346.00	<b>415.20</b>
600 x 625mm	1055	3601	450W	A, A+, C, H	86.0250	426.00	<b>511.20</b>
600 x 835mm	1407	4802	750W	A, A+, C, H	86.0251	543.00	<b>651.60</b>
600 x 1045mm	1759	6002	900W	A, A+, C, H	86.0252	663.00	<b>795.60</b>
600 x 1255mm	2111	7202	1200W	A, A+, C, H	86.0253	782.00	<b>938.40</b>
600 x 1395mm	2345	8003	1200W	A, A+, C, H	86.0474	939.00	<b>1126.80</b>

### Hadleigh Horizontal Aluminium Radiators - Matt Black

Size H x W	Watts	BTU	Element Output	Element Type	Code	£ Ex VAT	£ Inc VAT
600 x 485mm	821	2801	450W	A, A+, C, H	86.0257	346.00	<b>415.20</b>
600 x 625mm	1055	3601	450W	A, A+, C, H	86.0258	426.00	<b>511.20</b>
600 x 835mm	1407	4802	750W	A, A+, C, H	86.0259	543.00	<b>651.60</b>
600 x 1045mm	1759	6002	900W	A, A+, C, H	86.0260	663.00	<b>795.60</b>
600 x 1255mm	2111	7202	1200W	A, A+, C, H	86.0261	782.00	<b>938.40</b>
600 x 1395mm	2345	8003	1200W	A, A+, C, H	86.0475	939.00	<b>1126.80</b>

### FEATURES

- Special double profile construction for high heat output
  - Excellent heat conductivity and lightweight
  - Only requires a low water volume
  - Heats up very quickly
  - Radiators come with cover caps on top and bottom, same as radiator colour
  - Tested to BS EN 442 standards
  - 5 Year Manufacturer's Warranty\*
- \* With conditions

### TECHNICAL INFORMATION

All measurements in Height by Width. Heat output based on  $\Delta T60^{\circ}\text{C}$ . For matching valves see pages 301-309. Corrosion inhibitor must be added to the heating system and maintained. Flow diverter must only be fitted when radiator installed on central heating system. For indirect heating systems only. Tappings are the width of the rail and approx. 65mm off the wall.

### Radiator Valves

Page 301-309



For element types see pages 288-300.

Element can only be installed horizontally on the bottom header.

Radiators that are electric only are restricted to the heat output of the elements (Type C&H up to 900 watts).



### Matt White

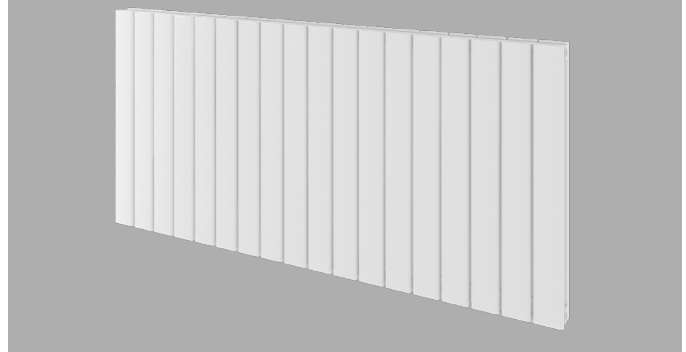

### Matt Anthracite

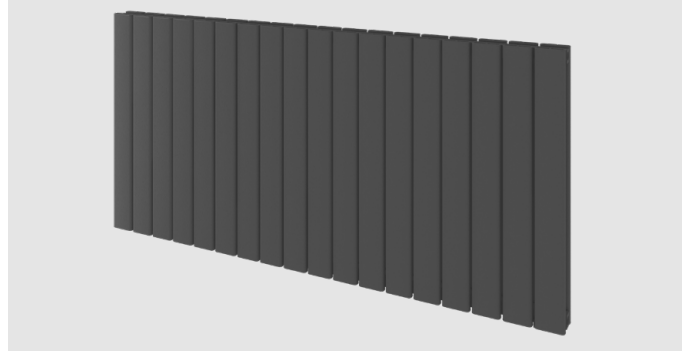

### Matt Black

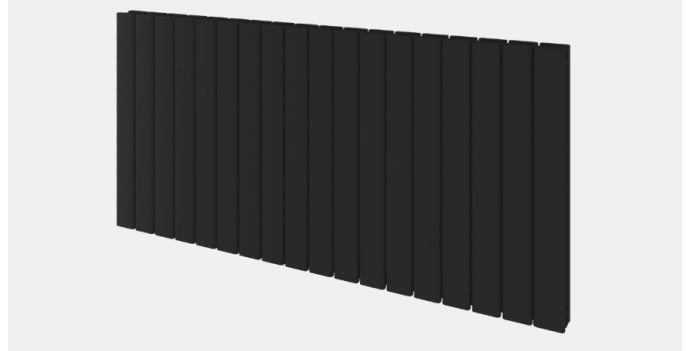

### Hadleigh Cover Caps - Chrome

Description	Code	£ Ex VAT	£ Inc VAT
Cover Cap Set 485mm	86.0297	67.00	<b>80.40</b>
Cover Cap Set 625mm	86.0298	81.00	<b>97.20</b>
Cover Cap Set 835mm	86.0299	102.00	<b>122.40</b>
Cover Cap Set 1045mm	86.0300	124.00	<b>148.80</b>
Cover Cap Set 1255mm	86.0301	149.00	<b>178.80</b>
Cover Cap Set 1395mm	86.0486	174.00	<b>208.80</b>

Cover cap sets only include cover caps for the top of the radiator.

# Aluminium Range

## VESIMA VERTICAL



Pictured 86.0085 Matt Black

A sleek elegant radiator with clean lines which will provide a stylish focus to any room. Available in three colours as well as horizontal and vertical designs. Additional towel hangers available with the vertical design to allow versatility.

### FEATURES

- Excellent heat conductivity and lightweight
- Only requires a low water volume
- Heats up very quickly
- Radiators come with cover caps on top and bottom, same as radiator colour
- Tested to BS EN 442 standards
- 5 Year Manufacturer's Warranty\*
- Can be single or dual fuel, or all electric
- \* With conditions

**Technical Tables & Drawings**  
Page 374-375

Warranty

**5**

Year

Heating

All Electric

Dual-Fuel

### Multi-Purpose Towel Hangers

Page 312



Vesima Vertical Aluminium Radiators - Matt White							
Size H x W	Watts	BTU	Element Output	Element Type	Code	£ Ex VAT	£ Inc VAT
1800 x 303mm	1068	3644	600W	A	86.0080	409.00	<b>490.80</b>
1800 x 403mm	1424	4859	900W	A	86.0083	514.00	<b>616.80</b>
1800 x 503mm	1780	6074	900W	A	86.0086	622.00	<b>746.40</b>
1800 x 603mm	2134	7282	900W	A	86.0476	790.00	<b>948.00</b>

Vesima Vertical Aluminium Radiators - Matt Anthracite							
Size H x W	Watts	BTU	Element Output	Element Type	Code	£ Ex VAT	£ Inc VAT
1800 x 303mm	1068	3644	600W	A	86.0081	409.00	<b>490.80</b>
1800 x 403mm	1424	4859	900W	A	86.0084	514.00	<b>616.80</b>
1800 x 503mm	1780	6074	900W	A	86.0087	601.00	<b>721.20</b>
1800 x 603mm	2134	7282	900W	A	86.0477	790.00	<b>948.00</b>

Vesima Vertical Aluminium Radiators - Matt Black							
Size H x W	Watts	BTU	Element Output	Element Type	Code	£ Ex VAT	£ Inc VAT
1800 x 303mm	1068	3644	600W	A	86.0082	409.00	<b>490.80</b>
1800 x 403mm	1424	4859	900W	A	86.0085	514.00	<b>616.80</b>
1800 x 503mm	1780	6074	900W	A	86.0088	622.00	<b>746.40</b>
1800 x 603mm	2134	7282	900W	A	86.0478	790.00	<b>948.00</b>

Prices include radiator and wall fixing sets, valves and accessories extra.

# Aluminium Range

## VESIMA VERTICAL



Matt White

Matt Anthracite

Matt Black

### VESIMA STANDARD TOWEL HANGERS

#### Vesima Standard Towel Hangers Premium Stainless Steel Mirror Polished

Description	Colour	Code	£ Ex VAT	£ Inc VAT
Towel Hanger 303mm	Premium Mirror Polished	86.0204	77.00	<b>92.40</b>
Towel Hanger 403mm	Premium Mirror Polished	86.0205	81.00	<b>97.20</b>
Towel Hanger 503mm	Premium Mirror Polished	86.0206	90.00	<b>108.00</b>
Towel Hanger 603mm	Premium Mirror Polished	86.0489	114.00	<b>136.80</b>

#### Vesima Standard Towel Hangers - Matt White

Description	Colour	Code	£ Ex VAT	£ Inc VAT
Towel Hanger 303mm	Matt White	89.0195	65.00	<b>78.00</b>
Towel Hanger 403mm	Matt White	89.0196	70.00	<b>84.00</b>
Towel Hanger 503mm	Matt White	89.0197	79.00	<b>94.80</b>
Towel Hanger 603mm	Matt White	89.1400	86.00	<b>103.20</b>

#### Vesima Standard Towel Hangers - Matt Anthracite

Description	Colour	Code	£ Ex VAT	£ Inc VAT
Towel Hanger 303mm	Matt Anthracite	89.0198	65.00	<b>78.00</b>
Towel Hanger 403mm	Matt Anthracite	89.0199	70.00	<b>84.00</b>
Towel Hanger 503mm	Matt Anthracite	89.0200	79.00	<b>94.80</b>
Towel Hanger 603mm	Matt Anthracite	89.1401	86.00	<b>103.20</b>

#### Vesima Standard Towel Hangers - Matt Black

Description	Colour	Code	£ Ex VAT	£ Inc VAT
Towel Hanger 303mm	Matt Black	89.0201	65.00	<b>78.00</b>
Towel Hanger 403mm	Matt Black	89.0202	70.00	<b>84.00</b>
Towel Hanger 503mm	Matt Black	89.0203	79.00	<b>94.80</b>
Towel Hanger 603mm	Matt Black	89.1402	86.00	<b>103.20</b>

#### Vesima Standard Towel Hangers - Chrome

Description	Colour	Code	£ Ex VAT	£ Inc VAT
Towel Hanger 303mm	Chrome	86.0104	55.00	<b>66.00</b>
Towel Hanger 403mm	Chrome	86.0105	65.00	<b>78.00</b>
Towel Hanger 503mm	Chrome	86.0106	70.00	<b>84.00</b>
Towel Hanger 603mm	Chrome	89.1403	77.00	<b>92.40</b>



Pictured 86.0083 Matt White with 86.0105  
Towel Hangers x3 & 86.0133 Cover Caps x2

### TECHNICAL INFORMATION

All measurements in Height by Width. Heat output based on  $\Delta T60^{\circ}\text{C}$ . For matching valves see pages 301-309. Corrosion inhibitor must be added to the heating system and maintained. Flow diverter must only be fitted when radiator installed on central heating system. For indirect heating systems only. Tappings are the width of the rail and 60 or 80mm off the wall.



#### Vesima Cover Cap Sets - Chrome

Description	Code	£ Ex VAT	£ Inc VAT
Cover Cap Set 303mm	86.0132	29.00	<b>34.80</b>
Cover Cap Set 403mm	86.0133	35.00	<b>42.00</b>
Cover Cap Set 503mm	86.0134	40.00	<b>48.00</b>
Cover Cap Set 603mm	86.0135	50.00	<b>60.00</b>

Cover cap sets only include cover caps for the top of the radiator.

For element types see pages 288-300.

Element can be installed vertically on the right-hand side or left-hand side on the bottom header. Radiators that are electric only are restricted to the heat output of the elements. For dual fuel installations, element must be installed on flow side.



# Aluminium Range

## VESIMA HORIZONTAL







Pictured 86.0101 Matt White & 86.0138 Cover Caps x2

A sleek elegant radiator with clean lines which will provide a stylish focus to any room. Available in three colours as well as horizontal and vertical designs.

### FEATURES

- Excellent heat conductivity and lightweight
- Only requires a low water volume
- Heats up very quickly
- Radiators come with cover caps on top and bottom, same as radiator colour
- Tested to BS EN 442 standards
- 5 Year Manufacturer's Warranty\*
- Can be single or dual fuel, or all electric
- \* With conditions

Warranty <b>5</b> Year	Heating 	All Electric 	Dual-Fuel 
------------------------------	--	---	--

**Technical Tables  
& Drawings**  
Page 374-375 

# Aluminium Range

## VESIMA HORIZONTAL

### Vesima Horizontal Aluminium Radiators - Matt White

Size H x W	Watts	BTU	Element Output	Element Type	Code	£ Ex VAT	£ Inc VAT
600 x 503mm	660	2252	300W	A, C, H	86.0089	287.00	<b>344.40</b>
600 x 603mm	792	2702	300W	A, C, H	86.0092	330.00	<b>396.00</b>
600 x 803mm	1056	3603	600W	A, C, H	86.0095	414.00	<b>496.80</b>
600 x 1003mm	1320	4504	600W	A, C, H	86.0098	502.00	<b>602.40</b>
600 x 1203mm	1584	5405	900W	A, C, H	86.0101	587.00	<b>704.40</b>
600 x 1403mm	1844	6293	900W	A, C, H	86.0479	717.00	<b>860.40</b>

### Vesima Horizontal Aluminium Radiators - Matt Anthracite

Size H x W	Watts	BTU	Element Output	Element Type	Code	£ Ex VAT	£ Inc VAT
600 x 503mm	660	2252	300W	A, C, H	86.0090	287.00	<b>344.40</b>
600 x 603mm	792	2702	300W	A, C, H	86.0093	330.00	<b>396.00</b>
600 x 803mm	1056	3603	600W	A, C, H	86.0096	414.00	<b>496.80</b>
600 x 1003mm	1320	4504	600W	A, C, H	86.0099	502.00	<b>602.40</b>
600 x 1203mm	1584	5405	900W	A, C, H	86.0102	587.00	<b>704.40</b>
600 x 1403mm	1844	6293	900W	A, C, H	86.0480	717.00	<b>860.40</b>

### Vesima Horizontal Aluminium Radiators - Matt Black

Size H x W	Watts	BTU	Element Output	Element Type	Code	£ Ex VAT	£ Inc VAT
600 x 503mm	660	2252	300W	A, C, H	86.0091	287.00	<b>344.40</b>
600 x 603mm	792	2702	300W	A, C, H	86.0094	330.00	<b>396.00</b>
600 x 803mm	1056	3603	600W	A, C, H	86.0097	414.00	<b>496.80</b>
600 x 1003mm	1320	4504	600W	A, C, H	86.0100	502.00	<b>602.40</b>
600 x 1203mm	1584	5405	900W	A, C, H	86.0103	587.00	<b>704.40</b>
600 x 1403mm	1844	6293	900W	A, C, H	86.0481	717.00	<b>860.40</b>

Prices include radiator and wall fixing sets, valves and accessories extra.

#### Matt White



#### Matt Anthracite

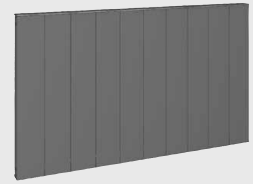

#### Matt Black

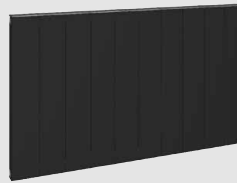

#### Vesima Cover Cap Sets

Cover cap sets only include cover caps for the top or bottom of the radiator.

### TECHNICAL INFORMATION

All measurements in Height by Width. Heat output based on  $\Delta T60^{\circ}\text{C}$ . For matching valves see pages 301-309. Corrosion inhibitor must be added to the heating system and maintained. Flow diverter must only be fitted when radiator installed on central heating system. For indirect heating systems only. Tappings are the width of the rail and 60 or 80mm off the wall. Element can only be installed horizontally on the bottom header.



Pictured 86.0480 Matt Anthracite



### Vesima Cover Cap Sets - Chrome

Description	Code	£ Ex VAT	£ Inc VAT
Cover Cap Set 503mm	86.0134	40.00	<b>48.00</b>
Cover Cap Set 603mm	86.0135	50.00	<b>60.00</b>
Cover Cap Set 803mm	86.0136	60.00	<b>72.00</b>
Cover Cap Set 1003mm	86.0137	77.00	<b>92.40</b>
Cover Cap Set 1203mm	86.0138	89.00	<b>106.80</b>
Cover Cap Set 1403mm	86.0487	97.00	<b>116.40</b>

### Radiator Valves

Page 301-309



For element types see pages 288-300.

Element can only be installed horizontally on the bottom header. Radiators that are electric only are restricted to the heat output of the elements (Type C&H up to 900 watts).



# Aluminium Range

## PRESTON VERTICAL



Pictured 89.0161 Matt White & 89.0164 Towel Hangers



Pictured 89.0793 Matt Black & 89.0164 Towel Hangers

### Multi-Purpose Towel Hangers

Page 312



A slimline radiator ideal for those situations where space is at a minimum. With the additional extra towel hangers this radiator is ideal for drying kitchen or bathroom towels. Available in three finishes.

#### FEATURES

- Excellent heat conductivity and lightweight
- Only requires a low water volume
- Heats up very quickly
- Radiators come with cover caps on top and bottom, same as radiator colour
- Tested to BS EN 442 standards
- 5 Year Manufacturer's Warranty\*
- Can be single or dual fuel, or all electric
- \* With conditions

**Technical Tables  
& Drawings**

Page 374-375



Warranty  
**5**  
Year

Heating

All Electric

Dual-Fuel



# Aluminium Range

## PRESTON VERTICAL

### Preston Aluminium Radiators - Matt White

Size H x W	Watts	BTU	Element Output	Element Type	Code	£ Ex VAT	£ Inc VAT
1200 x 185mm	374	1277	150W	A, A+, F, G	89.0791	197.00	<b>236.40</b>
1800 x 185mm	540	1843	300W	A, A+, F, G	89.0161	213.00	<b>255.60</b>

### Preston Aluminium Radiators - Matt Anthracite

Size H x W	Watts	BTU	Element Output	Element Type	Code	£ Ex VAT	£ Inc VAT
1200 x 185mm	374	1277	150W	A, A+, F, G	89.0792	197.00	<b>236.40</b>
1800 x 185mm	540	1843	300W	A, A+, F, G	89.0162	213.00	<b>255.60</b>

### Preston Aluminium Radiators - Matt Black

Size H x W	Watts	BTU	Element Output	Element Type	Code	£ Ex VAT	£ Inc VAT
1200 x 185mm	374	1277	150W	A, A+, F, G	89.0793	197.00	<b>236.40</b>
1800 x 185mm	540	1843	300W	A, A+, F, G	89.0163	213.00	<b>255.60</b>

Prices include radiator and wall fixing sets, valves and accessories extra.

### TECHNICAL INFORMATION

All measurements in Height by Width. Heat output based on  $\Delta T_{60}^{\circ}\text{C}$ . For matching valves see pages 301-309. Corrosion inhibitor must be added to the heating system and maintained. Flow diverter must only be fitted when radiator installed on central heating system. For indirect heating systems only. Tappings are the width of the rail and 33 or 53mm off the wall.



### Preston Cover Cap Sets - Chrome

Cap Set Size	Code	£ Ex VAT	£ Inc VAT
185mm	89.0175	17.00	<b>20.40</b>

Cover cap set only includes cover caps for the top or bottom of the radiator.

### Preston Standard Towel Hangers

Hanger Size	Colour	Code	£ Ex VAT	£ Inc VAT
185mm	Premium Mirror Polished	86.0207	67.00	<b>80.40</b>
185mm	Matt White	89.0204	54.00	<b>64.80</b>
185mm	Matt Anthracite	89.0205	54.00	<b>64.80</b>
185mm	Matt Black	89.0206	54.00	<b>64.80</b>
185mm	Chrome	89.0164	46.00	<b>55.20</b>

1800mm height radiator comes with 3 pre-drilled towel hanger locations, with a maximum of 3 towel hangers. 1200mm height radiators comes with 2 pre-drilled towel hanger locations, with a maximum of 2 towel hangers. The Preston Standard Towel Hangers will add approx. 23mm width on each side once fitted to the radiator.

**Can be fitted after installation only on high adjustment bracket fitting.**



#### Premium

86.0207

Matt White	Matt Anthracite	Matt Black	Chrome
89.0204	89.0205	89.0206	89.0164



SWATCHES AVAILABLE



For element types see pages 288-300.

Element can only be installed vertically on the right-hand side on the bottom header. Radiators that are electric only are restricted to the heat output of the elements. Element size can be increased to full capacity of rail if using element type F or G. For dual fuel installations, element must be installed on flow side.

Round Vent Caps  
Page 313



# Aluminium Range

## BERLINI VERTICAL



Pictured 86.0186 Polished Aluminium with 86.0110 Towel Hangers x3 & 86.0139 Cover Caps x2



Pictured 86.0107 Matt White with 86.0110 Towel Hangers

### Multi-Purpose Towel Hangers Page 312



This slimline radiator will be an ideal solution for those tight spaces. The radiator looks stunning paired with the towel hangers to complete the look. Available in four finishes, this radiator heats up quickly and is lightweight.

#### FEATURES

- Excellent heat conductivity and lightweight
- Only requires a low water volume
- Heats up very quickly
- Radiators come with cover caps on top and bottom, same as radiator colour
- Tested to BS EN 442 standards
- 5 Year Manufacturer's Warranty\*
- Can be single or dual fuel, or all electric
- \* With conditions

Technical Tables  
& Drawings  
Page 374-375



Warranty  
**5**  
Year

Heating

All Electric

Dual-Fuel

# Aluminium Range

## BERLINI VERTICAL

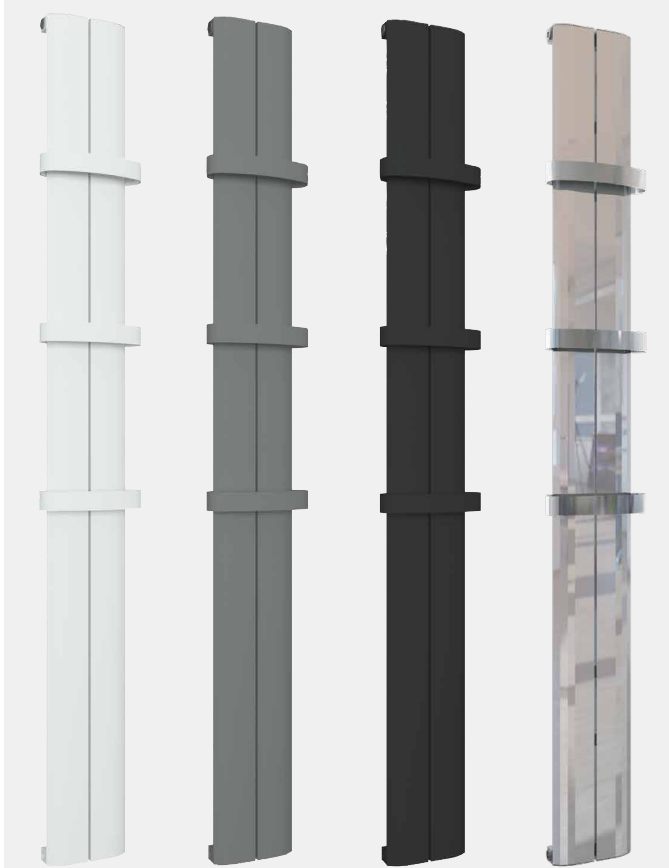

Matt White   Matt Anthracite   Matt Black   Polished

### Berlini Aluminium Radiator - Matt White

Size H x W	Watts	BTU	Element Output	Element Type	Code	£ Ex VAT	£ Inc VAT
1200 x 185mm	421	1438	150W	A, A+	86.0144	235.00	282.00
1800 x 185mm	632	2156	300W	A, A+	86.0107	250.00	300.00

### Berlini Aluminium Radiator - Matt Anthracite

Size H x W	Watts	BTU	Element Output	Element Type	Code	£ Ex VAT	£ Inc VAT
1200 x 185mm	421	1438	150W	A, A+	86.0145	235.00	282.00
1800 x 185mm	632	2156	300W	A, A+	86.0108	250.00	300.00

### Berlini Aluminium Radiator - Matt Black

Size H x W	Watts	BTU	Element Output	Element Type	Code	£ Ex VAT	£ Inc VAT
1200 x 185mm	421	1438	150W	A, A+	86.0146	235.00	282.00
1800 x 185mm	632	2156	300W	A, A+	86.0109	250.00	300.00

### Berlini Aluminium Radiator - Polished Aluminium

Size H x W	Watts	BTU	Element Output	Element Type	Code	£ Ex VAT	£ Inc VAT
1200 x 185mm	408	1393	150W	A, A+	86.0185	257.00	308.40
1800 x 185mm	611	2092	300W	A, A+	86.0186	292.00	350.40

Prices include radiator and wall fixing sets, valves and accessories extra.

### TECHNICAL INFORMATION

All measurements in Height by Width. Heat output based on  $\Delta T60^{\circ}\text{C}$ . For matching valves see pages 301-309. Corrosion inhibitor must be added to the heating system and maintained. Flow diverter must only be fitted when radiator installed on central heating system. For indirect heating systems only. Tappings are the width of the rail and 35 or 55mm off the wall.

For element types see pages 288-300.

Element can only be installed vertically on the right hand side on the bottom header. Radiators that are electric only are restricted to the heat output of the elements. For dual fuel installations, element must be installed on flow side.



Pictured 86.0145 Matt Anthracite with 89.0882R Multi-Purpose Towel Hanger & 86.0139 Cover Caps x2

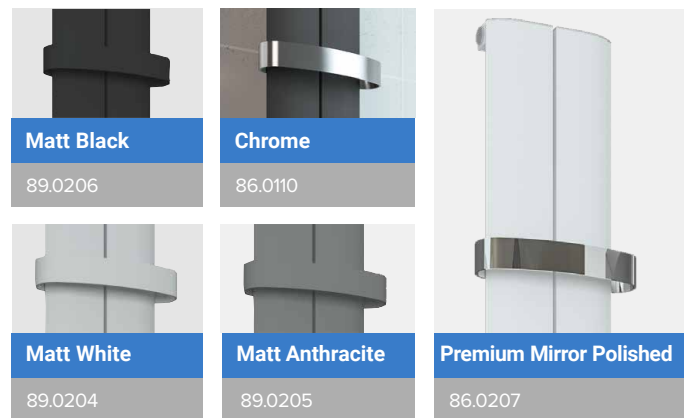

Matt Black

89.0206

Chrome

86.0110

Matt White

89.0204

Matt Anthracite

89.0205

Premium Mirror Polished

86.0207

### Berlini Standard Towel Hangers

Description	Colour	Code	£ Ex VAT	£ Inc VAT
Towel Hanger 185mm	Premium Mirror Polished	86.0207	67.00	80.40
Towel Hanger 185mm	Matt White	89.0204	54.00	64.80
Towel Hanger 185mm	Matt Anthracite	89.0205	54.00	64.80
Towel Hanger 185mm	Matt Black	89.0206	54.00	64.80
Towel Hanger 185mm	Chrome	86.0110	47.00	56.40

1800mm height radiator comes with 3 pre-drilled towel hanger locations, with a maximum of 3 towel hangers. 1200mm height radiators comes with 2 pre-drilled towel hanger locations, with a maximum of 2 towel hangers. The Berlini Standard Towel Hangers will add approx 23mm width on each side once fitted to the radiator. **Can be fitted after installation only on high adjustment bracket fitting.**

### Berlini Cover Cap Set - Chrome

Description	Code	£ Ex VAT	£ Inc VAT
Cover Cap Set 185mm	86.0139	26.00	31.20

Cover cap sets only include cover caps for the top of the radiator.



# Aluminium Range

## FAIRFORD VERTICAL



Warranty  
**5**  
Year

Heating

All Electric

Dual-Fuel

**Round Vent Caps**  
Page 313



Pictured 89.0227 Matt Anthracite with 89.0320 Towel Hangers

This slimline radiator is an ideal solution for those tight or tall spaces. This wavy element design has a curved front that will provide a stylish warmth to any room. Available in two colours as well as horizontal and vertical designs.

**FEATURES**

- Excellent heat conductivity and lightweight
  - Only requires a low water volume
  - Heats up very quickly
  - Radiators come with cover caps on top and bottom, same as radiator colour
  - Tested to BS EN 442 standards
  - 5 Year Manufacturer's Warranty\*
  - Can be single or dual fuel, or all electric
- \* With conditions

**Multi-Purpose Towel Hangers**

Page 312



**Technical Tables & Drawings**  
Page 376-377

# Aluminium Range

## FAIRFORD VERTICAL

### Fairford Vertical Aluminium Radiators - Matt White

Size H x W	Watts	BTU	Element Output	Element Type	Code	£ Ex VAT	£ Inc VAT
1200 x 375mm	760	2594	450W	A, A+, F, G	89.0221	398.00	<b>477.60</b>
1200 x 565mm	1144	3904	750W	A, A+, F, G	89.0737	565.00	<b>678.00</b>
1800 x 375mm	1140	3890	750W	A, A+, F, G	89.0222	460.00	<b>552.00</b>
1800 x 565mm	1716	5855	1000W	A, A+, F, G	89.0735	656.00	<b>787.20</b>

### Fairford Vertical Aluminium Radiators - Matt Anthracite

Size H x W	Watts	BTU	Element Output	Element Type	Code	£ Ex VAT	£ Inc VAT
1200 x 375mm	760	2594	450W	A, A+, F, G	89.0227	398.00	<b>477.60</b>
1200 x 565mm	1144	3904	750W	A, A+, F, G	89.0738	565.00	<b>678.00</b>
1800 x 375mm	1140	3890	750W	A, A+, F, G	89.0228	460.00	<b>552.00</b>
1800 x 565mm	1716	5855	1000W	A, A+, F, G	89.0736	656.00	<b>787.20</b>

Prices include radiator and wall fixing sets, valves and accessories extra.



### Fairford Cover Caps - Chrome

Description	Code	£ Ex VAT	£ Inc VAT
Cover Cap 375mm	89.0399	21.00	<b>25.20</b>
Cover Cap 565mm	89.0400	28.00	<b>33.60</b>

Cover cap set only includes cover caps for the top or bottom of the radiator.

For element types see pages 288-300.

Element can only be installed vertically on the right-hand side on the bottom header. Radiators that are electric only are restricted to the heat output of the elements. Element size can be increased to full capacity of rail if using element type F or G. For dual fuel installations, element must be installed on flow side.



### TECHNICAL INFORMATION

All measurements in Height by Width. Heat output based on  $\Delta T60^{\circ}\text{C}$ . For matching valves see pages 301-309. Corrosion inhibitor must be added to the heating system and maintained. Flow diverter must only be fitted when radiator installed on central heating system. For indirect heating systems only. Tappings are the width of the rail and 33 or 53mm off the wall.

### FAIRFORD STANDARD TOWEL HANGERS



#### Towel Hanger - Matt White

Size	Code	£ Ex VAT	£ Inc VAT
375mm	89.0318	56.00	<b>67.20</b>
565mm	89.0319	70.00	<b>84.00</b>

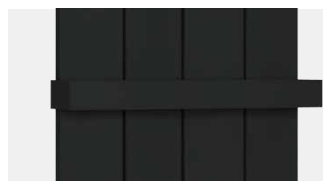

#### Towel Hanger - Matt Anthracite

Size	Code	£ Ex VAT	£ Inc VAT
375mm	89.0320	56.00	<b>67.20</b>
565mm	89.0321	70.00	<b>84.00</b>



#### Towel Hanger - Chrome

Size	Code	£ Ex VAT	£ Inc VAT
375mm	89.0322	56.00	<b>67.20</b>
565mm	89.0323	70.00	<b>84.00</b>

1800mm height radiators come with 3 pre-drilled towel hanger locations, with a maximum of 3 towel hangers.

1200mm height radiators come with 2 pre-drilled towel hanger locations, with a maximum of 2 towel hangers.

The standard towel hangers are compatible with the Vertical radiators. (Depending on the radiators and hangers width)

Can be fitted after installation only on high adjustment bracket fitting.



The Fairford Standard Towel Hangers will add approx 8mm width on each side once fitted to the radiator.



Pictured 89.0222 Matt White with 89.0322 Towel Hangers

# Aluminium Range

## FAIRFORD HORIZONTAL

<b>Warranty</b> <b>5</b> Year	<b>Heating</b> 	<b>All Electric</b> 	<b>Dual-Fuel</b> 
-------------------------------------	---	--	---



Pictured 89.0225 Matt Anthracite

This modern radiator has a curved front design that will provide a stylish warmth to any room. Available in two colours as well as horizontal and vertical designs.

### Fairford Horizontal Aluminium Radiators - Matt White

Size H x W	Watts	BTU	Element Output	Element Type	Code	£ Ex VAT	£ Inc VAT
600 x 375mm	392	1338	300W	A, A+	89.0217	231.00	<b>277.20</b>
600 x 565mm	591	2017	300W	A, A+, C, H	89.0218	324.00	<b>388.80</b>
600 x 945mm	987	3368	600W	A, A+, C, H	89.0219	531.00	<b>637.20</b>
600 x 1325mm	1382	4716	900W	A, A+, C, H	89.0220	731.00	<b>877.20</b>

### Fairford Horizontal Aluminium Radiators - Matt Anthracite

Size H x W	Watts	BTU	Element Output	Element Type	Code	£ Ex VAT	£ Inc VAT
600 x 375mm	392	1338	300W	A, A+	89.0223	231.00	<b>277.20</b>
600 x 565mm	591	2017	300W	A, A+, C, H	89.0224	324.00	<b>388.80</b>
600 x 945mm	987	3368	600W	A, A+, C, H	89.0225	531.00	<b>637.20</b>
600 x 1325mm	1382	4716	900W	A, A+, C, H	89.0226	731.00	<b>877.20</b>

Prices include radiator and wall fixing sets, valves and accessories extra.

### FEATURES

- Excellent heat conductivity and lightweight
  - Only requires a low water volume
  - Heats up very quickly
  - Radiators come with cover caps on top and bottom, same as radiator colour
  - Tested to BS EN 442 standards
  - 5 Year Manufacturer's Warranty\*
  - Can be single or dual fuel, or all electric
- \* With conditions

**Technical Tables & Drawings**  
Page 376-377



**Round Vent Caps**  
Page 313



# Aluminium Range

## FAIRFORD HORIZONTAL

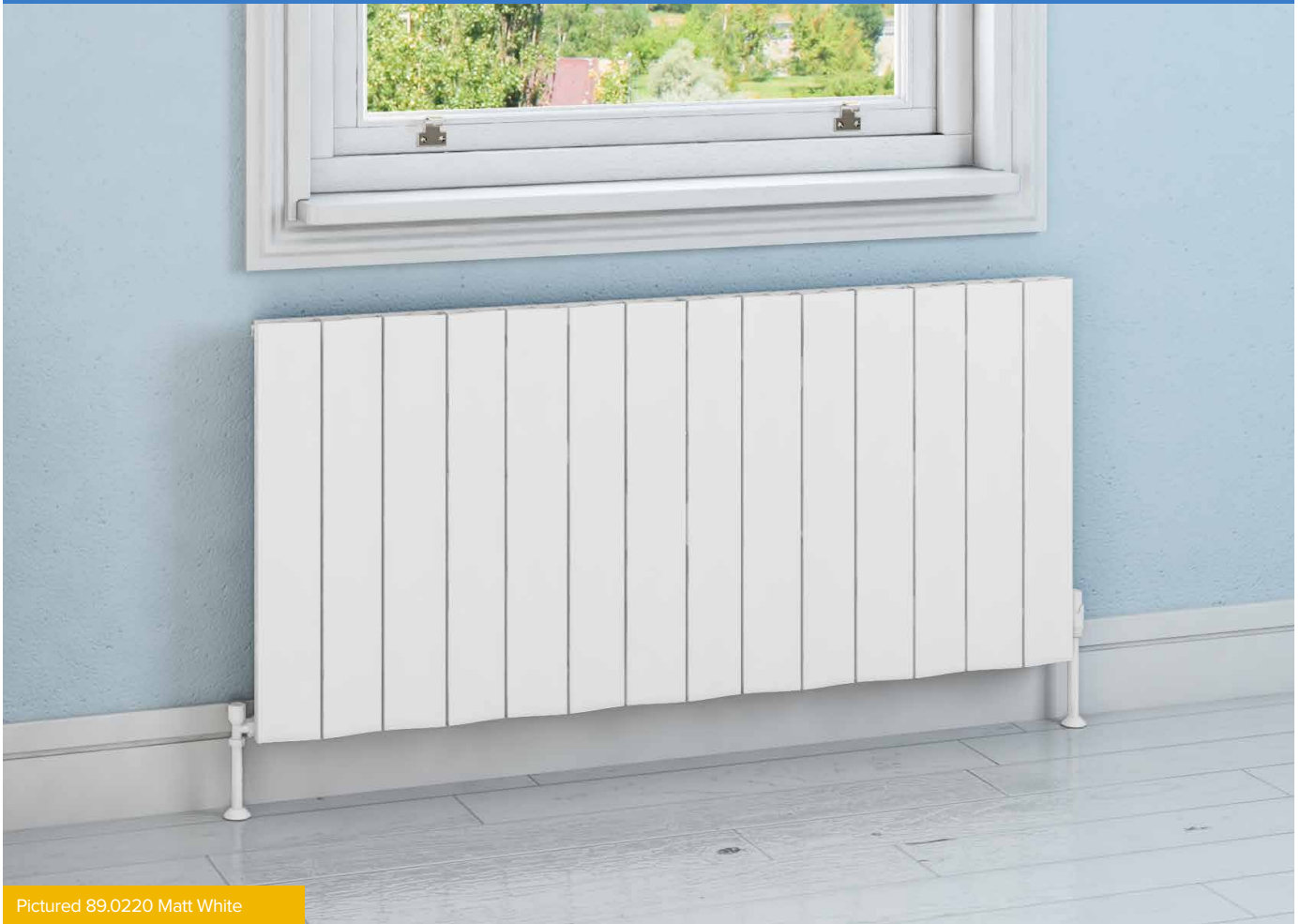

Pictured 89.0220 Matt White

### FAIRFORD STANDARD TOWEL HANGERS



#### Towel Hanger - Matt White

Size	Code	£ Ex VAT	£ Inc VAT
375mm*	89.0318	56.00	<b>67.20</b>
565mm**	89.0319	70.00	<b>84.00</b>

Suitable 375mm width radiators only\*

Suitable 565mm width radiators only\*\*

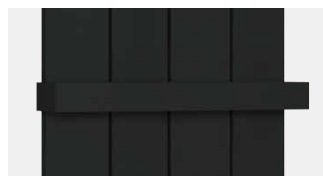

#### Towel Hanger - Matt Anthracite

Size	Code	£ Ex VAT	£ Inc VAT
375mm*	89.0320	56.00	<b>67.20</b>
565mm**	89.0321	70.00	<b>84.00</b>

Suitable 375mm width radiators only\*

Suitable 565mm width radiators only\*\*



#### Towel Hanger - Chrome

Size	Code	£ Ex VAT	£ Inc VAT
375mm*	89.0322	56.00	<b>67.20</b>
565mm**	89.0323	70.00	<b>84.00</b>

Suitable 375mm width radiators only\*

Suitable 565mm width radiators only\*\*

600mm height radiators come with 1 pre-drilled towel hanger location, with a maximum of 1 towel hanger. (only 375 and 565mm widths)

The Standard Towel Hangers are compatible with the Horizontal radiators. (Depending on the radiators and hangers width)

**Can be fitted after installation only on high adjustment bracket fitting.**

The Fairford Standard Towel Hangers will add approx 8mm width on each side once fitted to the radiator.



#### Fairford Cover Cap Set - Chrome

Description	Code	£ Ex VAT	£ Inc VAT
Cover Cap 375mm	89.0399	21.00	<b>25.20</b>
Cover Cap 565mm	89.0400	28.00	<b>33.60</b>
Cover Cap 945mm	89.0401	37.00	<b>44.40</b>
Cover Cap 1325mm	89.0402	50.00	<b>60.00</b>

Cover cap set only includes cover caps for the top or bottom of the radiator.

For element types see pages 288-300.

Element can only be installed horizontally on the bottom header. Radiators that are electric only are restricted to the heat output of the elements (Type C&H up to 900 watts).



#### TECHNICAL INFORMATION

All measurements in Height by Width. Heat output based on  $\Delta T60^{\circ}\text{C}$ . For matching valves see pages 301-309. Corrosion inhibitor must be added to the heating system and maintained. Flow diverter must only be fitted when radiator installed on central heating system. For indirect heating systems only. Tappings are the width of the rail and 33 or 53mm off the wall.

# Aluminium Range

## BURFORD VERTICAL

Pictured 89.0236 Matt White with 89.0342 Towel Hangers



This slimline radiator would be an ideal solution for those tight or tall spaces. This design has a curved front that will provide a stylish warmth to any room. Available in two colours as well as horizontal and vertical designs.

### FEATURES

- Excellent heat conductivity and lightweight
  - Only requires a low water volume
  - Heats up very quickly
  - Radiators come with cover caps on top and bottom, same as radiator colour
  - Tested to BS EN 442 standards
  - 5 Year Manufacturer's Warranty\*
  - Can be single or dual fuel, or all electric
- \* With conditions

For element types see pages 288-300.

Element can only be installed vertically on the right-hand side on the bottom header. Radiators that are electric only are restricted to the heat output of the elements. Element size can be increased to full capacity of rail if using element type F or G. For dual fuel installations, element must be installed on flow side.



**Round Vent Caps**  
Page 313



**Multi-Purpose Towel Hangers**  
Page 312



Warranty  
**5**  
Year

Heating

All Electric

Dual-Fuel

Technical Tables  
& Drawings  
Page 376-377



# Aluminium Range

## BURFORD VERTICAL

### Burford Vertical Aluminium Radiators - Matt White

Size H x W	Watts	BTU	Element Output	Element Type	Code	£ Ex VAT	£ Inc VAT
1800 x 275mm	972	3317	600W	A, A+, F, G	89.0234	434.00	<b>520.80</b>
1800 x 345mm	1209	4126	750W	A, A+, F, G	89.0235	519.00	<b>622.80</b>
1800 x 415mm	1443	4924	900W	A, A+, F, G	89.0236	618.00	<b>741.60</b>
1800 x 485mm	1676	5719	1000W	A, A+, F, G	89.0237	711.00	<b>853.20</b>

### Burford Vertical Aluminium Radiators - Matt Anthracite

Size H x W	Watts	BTU	Element Output	Element Type	Code	£ Ex VAT	£ Inc VAT
1800 x 275mm	972	3317	600W	A, A+, F, G	89.0243	434.00	<b>520.80</b>
1800 x 345mm	1209	4126	750W	A, A+, F, G	89.0244	519.00	<b>622.80</b>
1800 x 415mm	1443	4924	900W	A, A+, F, G	89.0245	618.00	<b>741.60</b>
1800 x 485mm	1676	5719	1000W	A, A+, F, G	89.0246	711.00	<b>853.20</b>

Prices include radiator and wall fixing sets, valves and accessories extra.

### TECHNICAL INFORMATION

All measurements in Height by Width. Heat output based on  $\Delta T60^{\circ}\text{C}$ . For matching valves see pages 301-309. Corrosion inhibitor must be added to the heating system and maintained. Flow diverter must only be fitted when radiator installed on central heating system. For indirect heating systems only. Tappings are the width of the rail and 33 or 53mm off the wall.



### Burford Cover Caps - Chrome

Description	Code	£ Ex VAT	£ Inc VAT
Cover Cap 275mm	89.0403	23.00	<b>27.60</b>
Cover Cap 345mm	89.0404	26.00	<b>31.20</b>
Cover Cap 415mm	89.0405	30.00	<b>36.00</b>
Cover Cap 485mm	89.0406	32.00	<b>38.40</b>

Cover cap set only includes cover caps for the top or bottom of the radiator.

## BURFORD STANDARD TOWEL HANGERS



### Towel Hanger - Matt White

Size	Code	£ Ex VAT	£ Inc VAT
275mm	89.0330	54.00	<b>64.80</b>
345mm	89.0331	56.00	<b>67.20</b>
415mm	89.0332	63.00	<b>75.60</b>
485mm	89.0333	73.00	<b>87.60</b>



### Towel Hanger - Matt Anthracite

Size	Code	£ Ex VAT	£ Inc VAT
275mm	89.0335	54.00	<b>64.80</b>
345mm	89.0336	56.00	<b>67.20</b>
415mm	89.0337	63.00	<b>75.60</b>
485mm	89.0338	73.00	<b>87.60</b>



### Towel Hanger - Chrome

Size	Code	£ Ex VAT	£ Inc VAT
275mm	89.0340	54.00	<b>64.80</b>
345mm	89.0341	56.00	<b>67.20</b>
415mm	89.0342	63.00	<b>75.60</b>
485mm	89.0343	73.00	<b>87.60</b>

1800mm height radiators come with 3 pre-drilled towel hanger locations, with a maximum of 3 towel hangers. (all widths; 275, 345, 415 and 485mm)

The Standard Towel Hangers are compatible with the Vertical radiators. (Depending on the radiators and hangers width)

**Can be fitted after installation only on high adjustment bracket fitting.**

The Burford Standard Towel Hangers will add approx 50mm width on each side once fitted to the radiator.



Pictured 89.0243 Matt Anthracite with 89.0891L Multi-Purpose Towel Hanger

# Aluminium Range

## BURFORD HORIZONTAL

Warranty

**5**  
Year

Heating



All Electric



Dual-Fuel



Pictured 89.0230 Matt White with 89.0344 Towel Hanger

This modern radiator has a curved front design that will provide a stylish warmth to any room. Available in two colours as well as horizontal and vertical designs.

### Burford Horizontal Aluminium Radiators - Matt White

Size H x W	Watts	BTU	Element Output	Element Type	Code	£ Ex VAT	£ Inc VAT
600 x 485mm	606	2068	300W	A, A+, C, H	89.0229	369.00	442.80
600 x 625mm	772	2635	450W	A, A+, C, H	89.0230	460.00	552.00
600 x 835mm	1020	3481	600W	A, A+, C, H	89.0231	609.00	730.80
600 x 1045mm	1265	4317	750W	A, A+, C, H	89.0232	750.00	900.00
600 x 1185mm	1427	4869	900W	A, A+, C, H	89.0233	840.00	1008.00

### Burford Horizontal Aluminium Radiators - Matt Anthracite

Size H x W	Watts	BTU	Element Output	Element Type	Code	£ Ex VAT	£ Inc VAT
600 x 485mm	606	2068	300W	A, A+, C, H	89.0238	369.00	442.80
600 x 625mm	772	2635	450W	A, A+, C, H	89.0239	460.00	552.00
600 x 835mm	1020	3481	600W	A, A+, C, H	89.0240	609.00	730.80
600 x 1045mm	1265	4317	750W	A, A+, C, H	89.0241	750.00	900.00
600 x 1185mm	1427	4869	900W	A, A+, C, H	89.0242	840.00	1008.00

Prices include radiator and wall fixing sets, valves and accessories extra.

### FEATURES

- Excellent heat conductivity and lightweight
  - Only requires a low water volume
  - Heats up very quickly
  - Radiators come with cover caps on top and bottom, same as radiator colour
  - Tested to BS EN 442 standards
  - 5 Year Manufacturer's Warranty\*
  - Can be single or dual fuel, or all electric
- \* With conditions

Technical Tables  
& Drawings  
Page 376-377



### Multi-Purpose Towel Hangers Page 312

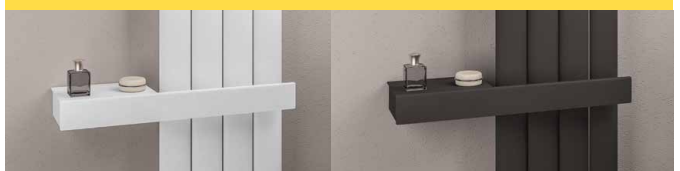

# Aluminium Range

## BURFORD HORIZONTAL

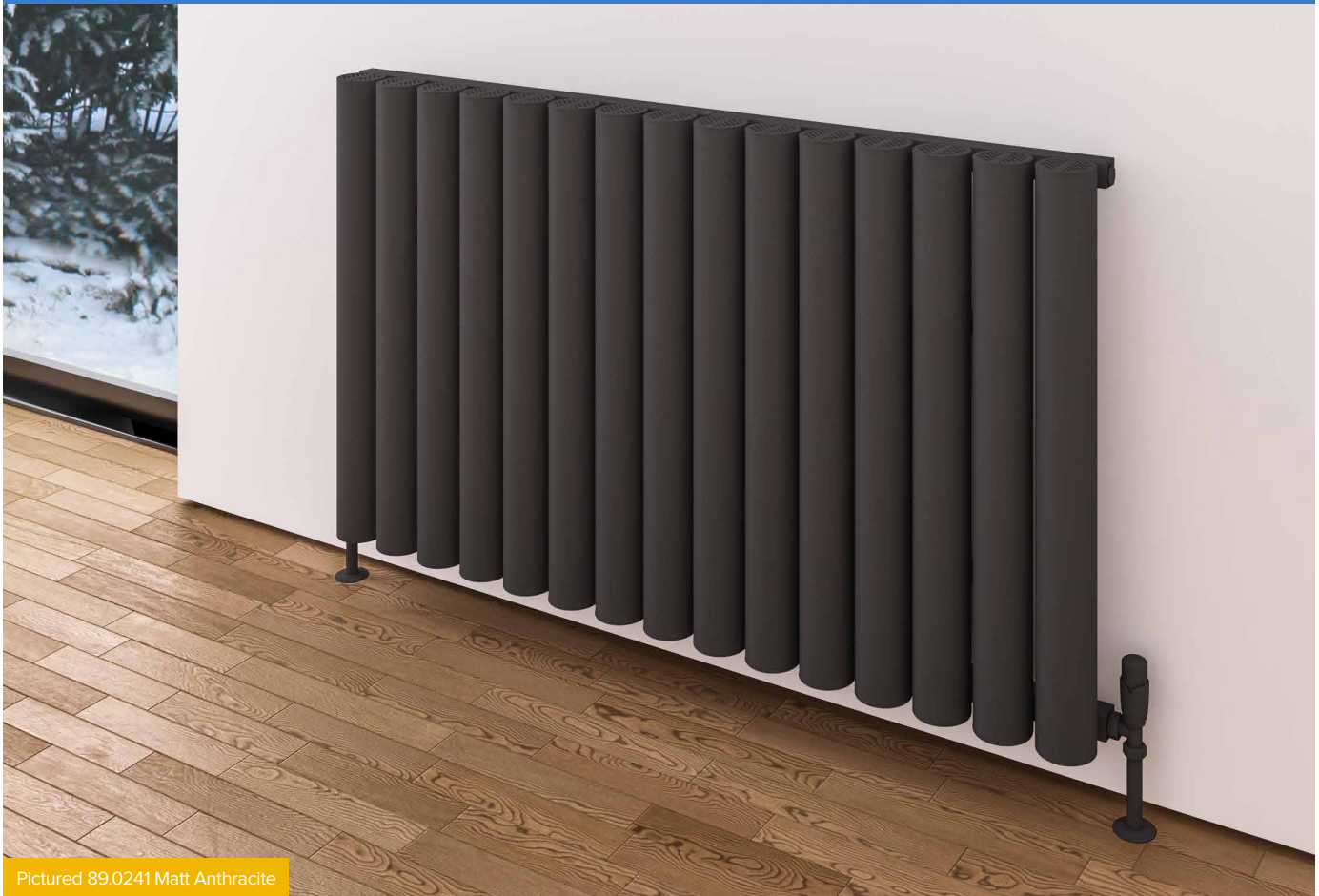

Pictured 89.0241 Matt Anthracite

## BURFORD STANDARD TOWEL HANGERS



### Towel Hanger - Matt White

Size	Code	£ Ex VAT	£ Inc VAT
485mm*	89.0333	73.00	<b>87.60</b>
625mm**	89.0334	83.00	<b>99.60</b>

Suitable 485mm width radiators only\*

Suitable 625mm width radiators only\*\*



### Towel Hanger - Matt Anthracite

Size	Code	£ Ex VAT	£ Inc VAT
485mm*	89.0338	73.00	<b>87.60</b>
625mm**	89.0339	83.00	<b>99.60</b>

Suitable 485mm width radiators only\*

Suitable 625mm width radiators only\*\*



### Towel Hanger - Chrome

Size	Code	£ Ex VAT	£ Inc VAT
485mm*	89.0343	73.00	<b>87.60</b>
625mm**	89.0344	83.00	<b>99.60</b>

Suitable 485mm width radiators only\*

Suitable 625mm width radiators only\*\*

600mm height radiators come with 1 pre-drilled towel hanger location, with a maximum of 1 towel hanger. (only 485 and 625mm widths)

The Standard Towel Hangers are compatible with the Horizontal radiators. (Depending on the radiators and hangers width)

**Can be fitted after installation only on high adjustment bracket fitting.**

The Burford Standard Towel Hangers will add approx 50mm width on each side once fitted to the radiator.



### Burford Cover Caps - Chrome

Description	Code	£ Ex VAT	£ Inc VAT
Cover Cap 485mm	89.0406	32.00	<b>38.40</b>
Cover Cap 625mm	89.0407	35.00	<b>42.00</b>
Cover Cap 835mm	89.0408	45.00	<b>54.00</b>
Cover Cap 1045mm	89.0409	52.00	<b>62.40</b>
Cover Cap 1185mm	89.0410	56.00	<b>67.20</b>

Cover cap set only includes cover caps for the top or bottom of the radiator.

For element types see pages 288-300.

Element can only be installed horizontally on the bottom header. Radiators that are electric only are restricted to the heat output of the elements (Type C&H up to 900 watts).

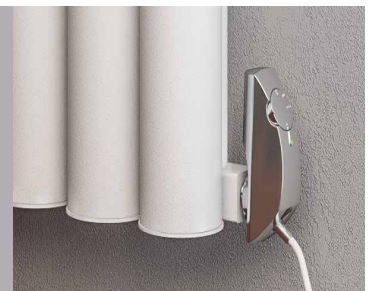

### Round Vent Caps

Page 313



### TECHNICAL INFORMATION

All measurements in Height by Width. Heat output based on  $\Delta T60^{\circ}\text{C}$ . For matching valves see pages 301-309. Corrosion inhibitor must be added to the heating system and maintained. Flow diverter must only be fitted when radiator installed on central heating system. For indirect heating systems only. Tappings are the width of the rail and 33 or 53mm off the wall.

# Aluminium Range

## KELMSCOTT VERTICAL

Pictured 89.0255 Matt White with 89.0358 Towel Hangers



This slimline radiator would be an ideal solution for those tight or tall spaces. This design has a curved front that will provide a stylish warmth to any room. Available in two colours as well as horizontal and vertical designs.

### FEATURES

- Excellent heat conductivity and lightweight
  - Only requires a low water volume
  - Heats up very quickly
  - Radiators come with cover caps on top and bottom, same as radiator colour
  - Tested to BS EN 442 standards
  - 5 Year Manufacturer's Warranty\*
  - Can be single or dual fuel, or all electric
- \* With conditions

For element types see pages 288-300.

Element can only be installed vertically on the right-hand side on the bottom header. Radiators that are electric only are restricted to the heat output of the elements. Element size can be increased to full capacity of rail if using element type F or G. For dual fuel installations, element must be installed on flow side.



**Round Vent Caps**  
Page 313



**Multi-Purpose Towel Hangers**  
Page 312



<p>Warranty</p> <p><b>5</b></p> <p>Year</p>	<p>Heating</p>	<p>All Electric</p>	<p>Dual-Fuel</p>
---	----------------	---------------------	------------------

**Technical Tables & Drawings**  
Page 376-377

# Aluminium Range

## KELMSCOTT VERTICAL

### Kelmscott Vertical Aluminium Radiators - Matt White

Size H x W	Watts	BTU	Element Output	Element Type	Code	£ Ex VAT	£ Inc VAT
1800 x 275mm	957	3266	600W	A, A+, F, G	89.0252	415.00	498.00
1800 x 345mm	1195	4078	750W	A, A+, F, G	89.0253	500.00	600.00
1800 x 415mm	1431	4883	900W	A, A+, F, G	89.0254	592.00	710.40
1800 x 485mm	1666	5685	1000W	A, A+, F, G	89.0255	682.00	818.40

### Kelmscott Vertical Aluminium Radiators - Matt Anthracite

Size H x W	Watts	BTU	Element Output	Element Type	Code	£ Ex VAT	£ Inc VAT
1800 x 275mm	957	3266	600W	A, A+, F, G	89.0261	415.00	498.00
1800 x 345mm	1195	4078	750W	A, A+, F, G	89.0262	500.00	600.00
1800 x 415mm	1431	4883	900W	A, A+, F, G	89.0263	592.00	710.40
1800 x 485mm	1666	5685	1000W	A, A+, F, G	89.0264	682.00	818.40

Prices include radiator and wall fixing sets, valves and accessories extra.

### TECHNICAL INFORMATION

All measurements in Height by Width. Heat output based on ▲T60°C. For matching valves see pages 301-309. Corrosion inhibitor must be added to the heating system and maintained. Flow diverter must only be fitted when radiator installed on central heating system. For indirect heating systems only. Tappings are the width of the rail and 33 or 53mm off the wall.

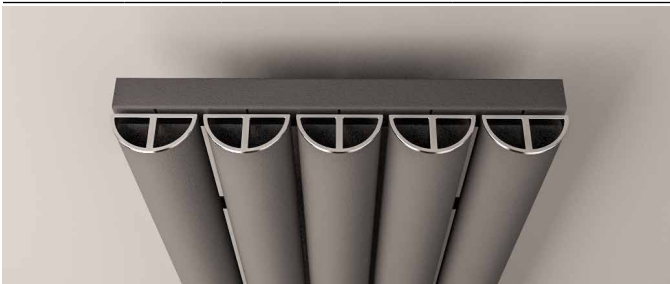

### Kelmscott Cover Cap Set - Chrome

Description	Code	£ Ex VAT	£ Inc VAT
Cover Cap 275mm	89.0411	21.00	25.20
Cover Cap 345mm	89.0412	24.00	28.80
Cover Cap 415mm	89.0413	26.00	31.20
Cover Cap 485mm	89.0414	30.00	36.00

Cover cap set only includes cover caps for the top or bottom of the radiator.

## KELMSCOTT STANDARD TOWEL HANGERS



### Towel Hanger - Matt White

Size	Code	£ Ex VAT	£ Inc VAT
275mm	89.0345	52.00	62.40
345mm	89.0346	53.00	63.60
415mm	89.0347	56.00	67.20
485mm	89.0348	69.00	82.80



### Towel Hanger - Matt Anthracite

Size	Code	£ Ex VAT	£ Inc VAT
275mm	89.0350	52.00	62.40
345mm	89.0351	53.00	63.60
415mm	89.0352	56.00	67.20
485mm	89.0353	69.00	82.80



### Towel Hanger - Chrome

Size	Code	£ Ex VAT	£ Inc VAT
275mm	89.0355	52.00	62.40
345mm	89.0356	53.00	63.60
415mm	89.0357	56.00	67.20
485mm	89.0358	69.00	82.80

1800mm height radiators come with 3 pre-drilled towel hanger locations, with a maximum of 3 towel hangers. (all widths; 275, 345, 415 and 485mm)

The Standard Towel Hangers are only compatible with the Vertical radiators. (Depending on the radiators and hangers width)

**Can be fitted after installation only on high adjustment bracket fitting.**

The Kelmscott Standard Towel Hangers will add approx 43mm width on each side once fitted to the radiator.

Pictured 89.0262 Matt Anthracite with 89.0351 Towel Hangers

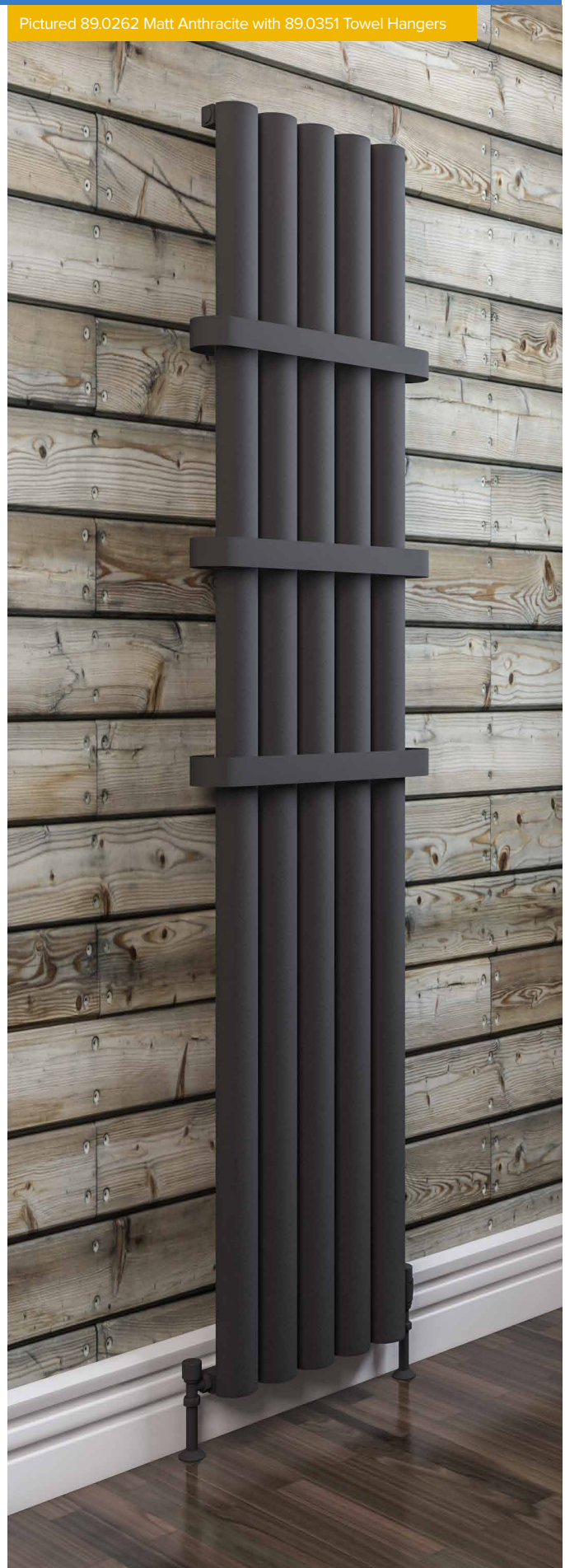

# Aluminium Range

## KELMSCOTT HORIZONTAL

Pictured 89.0257 Matt Anthracite with 89.0415 x 2 Cover Caps



Warranty

# 5

Year

Heating

All Electric

Dual-Fuel

This modern radiator has a curved front design that will provide a stylish warmth to any room. Available in two colours as well as horizontal and vertical designs.

### Kelmscott Horizontal Aluminium Radiators - Matt White

Size H x W	Watts	BTU	Element Output	Element Type	Code	£ Ex VAT	£ Inc VAT
600 x 485mm	603	2058	300W	A, A+, C, H	89.0247	350.00	<b>420.00</b>
600 x 625mm	773	2638	450W	A, A+, C, H	89.0248	441.00	<b>529.20</b>
600 x 835mm	1025	3498	600W	A, A+, C, H	89.0249	583.00	<b>699.60</b>
600 x 1045mm	1277	4358	750W	A, A+, C, H	89.0250	722.00	<b>866.40</b>
600 x 1185mm	1444	4927	900W	A, A+, C, H	89.0251	807.00	<b>968.40</b>

### Kelmscott Horizontal Aluminium Radiators - Matt Anthracite

Size H x W	Watts	BTU	Element Output	Element Type	Code	£ Ex VAT	£ Inc VAT
600 x 485mm	603	2058	300W	A, A+, C, H	89.0256	350.00	<b>420.00</b>
600 x 625mm	773	2638	450W	A, A+, C, H	89.0257	441.00	<b>529.20</b>
600 x 835mm	1025	3498	600W	A, A+, C, H	89.0258	583.00	<b>699.60</b>
600 x 1045mm	1277	4358	750W	A, A+, C, H	89.0259	722.00	<b>866.40</b>
600 x 1185mm	1444	4927	900W	A, A+, C, H	89.0260	807.00	<b>968.40</b>

Prices include radiator and wall fixing sets, valves and accessories extra.

### FEATURES

- Excellent heat conductivity and lightweight
  - Only requires a low water volume
  - Heats up very quickly
  - Radiators come with cover caps on top and bottom, same as radiator colour
  - Tested to BS EN 442 standards
  - 5 Year Manufacturer's Warranty\*
  - Can be single or dual fuel, or all electric
- \* With conditions

**Technical Tables & Drawings**  
Page 378-379



### Multi-Purpose Towel Hangers

Page 312



# Aluminium Range

## KELMSCOTT HORIZONTAL



Pictured 89.0250 Matt White

### KELMSCOTT STANDARD TOWEL HANGERS



#### Towel Hanger - Matt White

Size	Code	£ Ex VAT	£ Inc VAT
485mm*	89.0348	69.00	<b>82.80</b>
625mm**	89.0349	78.00	<b>93.60</b>

Suitable 485mm width radiators only\*

Suitable 625mm width radiators only\*\*



#### Towel Hanger - Matt Anthracite

Size	Code	£ Ex VAT	£ Inc VAT
485mm*	89.0353	69.00	<b>82.80</b>
625mm**	89.0354	78.00	<b>93.60</b>

Suitable 485mm width radiators only\*

Suitable 625mm width radiators only\*\*



#### Towel Hanger - Chrome

Size	Code	£ Ex VAT	£ Inc VAT
485mm*	89.0358	69.00	<b>82.80</b>
625mm**	89.0359	78.00	<b>93.60</b>

Suitable 485mm width radiators only\*

Suitable 625mm width radiators only\*\*

600mm height radiators come with 1 pre-drilled towel hanger location, with a maximum of 1 towel hanger. (only 485 and 625mm widths)

The Standard Towel Hangers are compatible with the Horizontal radiators. (Depending on the radiators and hangers width)

**Can be fitted after installation only on high adjustment bracket fitting.**

The KelmScott Standard Towel Hangers will add approx 43mm width on each side once fitted to the radiator.



#### KelmScott Cover Caps - Chrome

Description	Code	£ Ex VAT	£ Inc VAT
Cover Cap 485mm	89.0414	30.00	<b>36.00</b>
Cover Cap 625mm	89.0415	34.00	<b>40.80</b>
Cover Cap 835mm	89.0416	41.00	<b>49.20</b>
Cover Cap 1045mm	89.0417	47.00	<b>56.40</b>
Cover Cap 1185mm	89.0418	52.00	<b>62.40</b>

Cover cap set only includes cover caps for the top or bottom of the radiator.

For element types see pages 288-300.

Element can only be installed horizontally on the bottom header. Radiators that are electric only are restricted to the heat output of the elements (Type C&H up to 900 watts).



#### Round Vent Caps

Page 313



#### TECHNICAL INFORMATION

All measurements in Height by Width. Heat output based on  $\Delta T60^{\circ}C$ . For matching valves see pages 301-309. Corrosion inhibitor must be added to the heating system and maintained. Flow diverter must only be fitted when radiator installed on central heating system. For indirect heating systems only. Tappings are the width of the rail and 33 or 53mm off the wall.

# Aluminium Range

## WITNEY VERTICAL

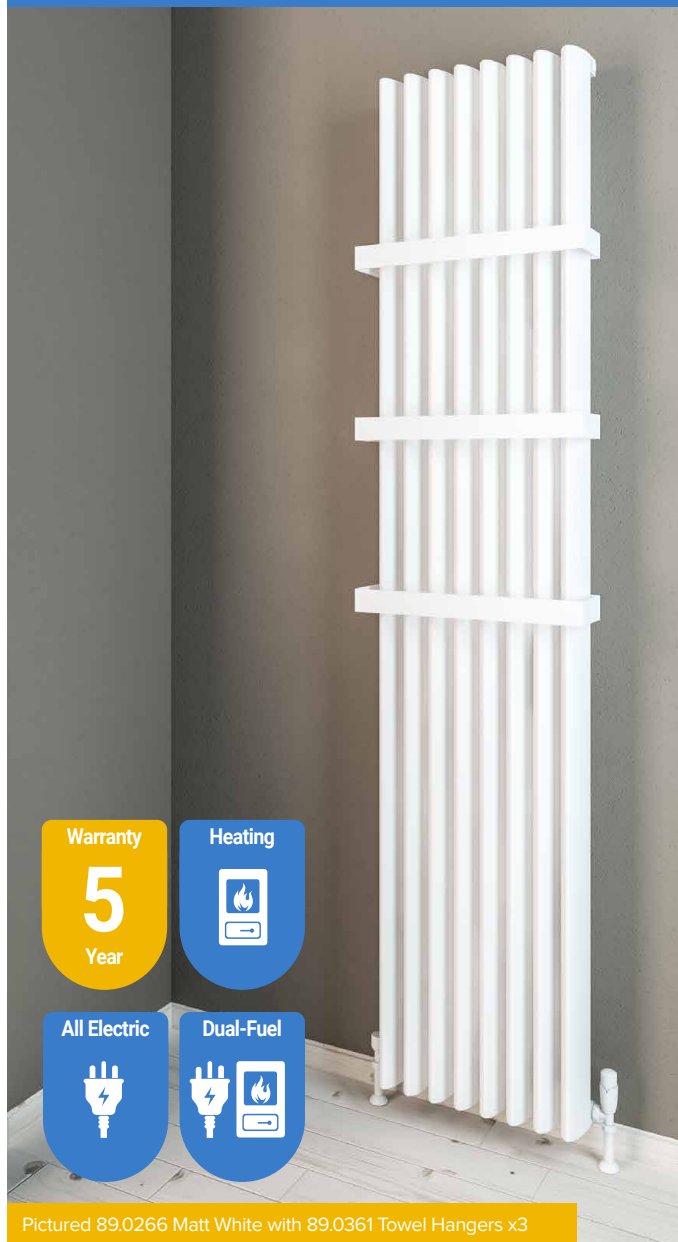

A high heat capacity vertical radiator ideal for those situations where space is at a minimum. Available in two finishes, three widths and one height.

### Witney Vertical Aluminium Radiators - Matt White

Size H x W	Watts	BTU	Element Output	Element Type	Code	£ Ex VAT	£ Inc VAT
1800 x 280mm	1252	4272	750W	A, A+, F, G	89.0265	586.00	703.20
1800 x 375mm	1648	5623	1000W	A, A+, F, G	89.0266	772.00	926.40
1800 x 470mm	2039	6958	1200W	A, A+, F, G	89.0267	930.00	1116.00

### Witney Vertical Aluminium Radiators - Matt Anthracite

Size H x W	Watts	BTU	Element Output	Element Type	Code	£ Ex VAT	£ Inc VAT
1800 x 280mm	1252	4272	750W	A, A+, F, G	89.0268	586.00	703.20
1800 x 375mm	1648	5623	1000W	A, A+, F, G	89.0269	772.00	926.40
1800 x 470mm	2039	6958	1200W	A, A+, F, G	89.0270	930.00	1116.00

Prices include radiator and wall fixing sets, valves and accessories extra.

### FEATURES

- Excellent heat conductivity and lightweight
- Only requires a low water volume
- Heats up very quickly
- Radiators come with cover caps on top and bottom, same as radiator colour
- Tested to BS EN 442 standards
- 5 Year Manufacturer's Warranty\*
- Can be single or dual fuel, or all electric
- \* With conditions

**Technical Tables & Drawings**  
Page 378-379



### TECHNICAL INFORMATION

All measurements in Height by Width. Heat output based on  $\Delta T60^{\circ}C$ . For matching valves see pages 301-309. Corrosion inhibitor must be added to the heating system and maintained. Flow diverter must only be fitted when radiator installed on central heating system. For indirect heating systems only. Tappings are the width of the rail and 33 or 53mm off the wall.

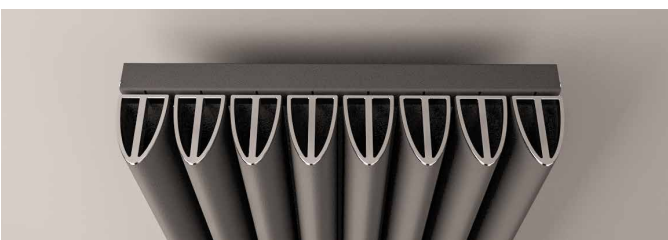

### Witney Cover Cap Set - Chrome

Description	Code	£ Ex VAT	£ Inc VAT
Cover Cap 280mm	89.0419	32.00	38.40
Cover Cap 375mm	89.0420	38.00	45.60
Cover Cap 470mm	89.0421	46.00	55.20

Cover cap set only includes cover caps for the top or bottom of the radiator.

For element types see pages 288-300.

Element can only be installed vertically on the right-hand side on the bottom header. Radiators that are electric only are restricted to the heat output of the elements. Element size can be increased to full capacity of rail if using element type F or G. For dual fuel installations, element must be installed on flow side.



## WITNEY STANDARD TOWEL HANGERS



### Towel Hanger - Matt White

Size	Code	£ Ex VAT	£ Inc VAT
280mm	89.0360	62.00	74.40
375mm	89.0361	66.00	79.20
470mm	89.0362	74.00	88.80



### Towel Hanger - Matt Anthracite

Size	Code	£ Ex VAT	£ Inc VAT
280mm	89.0363	62.00	74.40
375mm	89.0364	66.00	79.20
470mm	89.0365	74.00	88.80



### Towel Hanger - Chrome

Size	Code	£ Ex VAT	£ Inc VAT
280mm	89.0366	62.00	74.40
375mm	89.0367	66.00	79.20
470mm	89.0368	74.00	88.80

1800mm height radiators come with 3 pre-drilled towel hanger locations, with a maximum of 3 towel hangers. (all widths; 280, 375 and 470mm)

Can be fitted after installation only on high adjustment bracket fitting.

The Witney Towel Hangers will add approx 8mm width on each side once fitted to the radiator.

### Radiator Valves

Page 301-309





# Aluminium Range

## WITNEY HORIZONTAL



Pictured 89.0943 Matt White



Pictured 89.0978 Matt Anthracite

A high heat capacity horizontal radiator that will provide a stylish warmth to any room. Available in two finishes and five widths.

### Witney Horizontal Aluminium Radiators - Matt White

Size H x W	Watts	BTU	Element Output	Element Type	Code	£ Ex VAT	£ Inc VAT
600 x 470mm	823	2809	300W	A, A+, C, H	89.0941	522.00	<b>626.40</b>
600 x 660mm	1132	3863	600W	A, A+, C, H	89.0942	723.00	<b>867.60</b>
600 x 850mm	1437	4904	900W	A, A+, C, H	89.0943	920.00	<b>1104.00</b>
600 x 1040mm	1737	5927	1000W	A, A+, C, H	89.0944	1116.00	<b>1339.20</b>
600 x 1230mm	2034	6941	1200W	A, A+, C, H	89.0945	1305.00	<b>1566.00</b>

### Witney Horizontal Aluminium Radiators - Matt Anthracite

Size H x W	Watts	BTU	Element Output	Element Type	Code	£ Ex VAT	£ Inc VAT
600 x 470mm	823	2809	300W	A, A+, C, H	89.0974	522.00	<b>626.40</b>
600 x 660mm	1132	3863	600W	A, A+, C, H	89.0975	723.00	<b>867.60</b>
600 x 850mm	1437	4904	900W	A, A+, C, H	89.0976	920.00	<b>1104.00</b>
600 x 1040mm	1737	5927	1000W	A, A+, C, H	89.0977	1116.00	<b>1339.20</b>
600 x 1230mm	2034	6941	1200W	A, A+, C, H	89.0978	1305.00	<b>1566.00</b>

Prices include radiator and wall fixing sets, valves and accessories extra.

### FEATURES

- Excellent heat conductivity and lightweight
- Only requires a low water volume
- Heats up very quickly
- Radiators come with cover caps on top and bottom, same as radiator colour
- Tested to BS EN 442 standards
- 5 Year Manufacturer's Warranty\*
- Can be single or dual fuel, or all electric
- \* With conditions

### Technical Tables

#### & Drawings

Page 378-379



### Witney Cover Cap Set - Chrome

Description	Code	£ Ex VAT	£ Inc VAT
Cover Cap 470mm	89.0421	46.00	<b>55.20</b>
Cover Cap 660mm	89.1407	60.00	<b>72.00</b>
Cover Cap 850mm	89.1408	74.00	<b>88.80</b>
Cover Cap 1040mm	89.1409	91.00	<b>109.20</b>
Cover Cap 1230mm	89.1410	108.00	<b>129.60</b>

Cover cap set only includes cover caps for the top or bottom of the radiator.

For element types see pages 288-300.

Element can only be installed horizontally on the bottom header. Radiators that are electric only are restricted to the heat output of the elements (Type C&H up to 900 watts).



# Aluminium Range

## PELAGO

Pictured 86.0224 Polished Aluminium



With its slim construction and modern design, the Pelago aluminium towel rail is ready to heat up your towels.

### FEATURES

- Excellent heat conductivity and lightweight
- Only requires a low water volume
- Heats up very quickly
- Tested to BS EN 442 standards
- 5 Year Manufacturer's Warranty\*
- Can be single or dual fuel, or all electric
- \* With conditions

**Technical Tables  
& Drawings**  
Page 362-363



### Pelago - Matt White

Size H x W	Watts	BTU	Element Output	Element Type	Code	£ Ex VAT	£ Inc VAT
600 x 500mm	296	1011	150W	A, A+	86.0208	151.00	181.20
600 x 600mm	356	1213	150W	A, A+	86.0209	162.00	194.40
1200 x 500mm	566	1931	300W	A, A+	86.0214	248.00	297.60
1200 x 600mm	679	2317	300W	A, A+	86.0215	266.00	319.20
1800 x 500mm	907	3094	300W	A, A+	86.0220	353.00	423.60
1800 x 600mm	1088	3712	600W	A, A+	86.0221	382.00	458.40

### Pelago - Matt Anthracite

Size H x W	Watts	BTU	Element Output	Element Type	Code	£ Ex VAT	£ Inc VAT
600 x 500mm	296	1011	150W	A, A+	86.0210	151.00	181.20
600 x 600mm	356	1213	150W	A, A+	86.0211	162.00	194.40
1200 x 500mm	566	1931	300W	A, A+	86.0216	248.00	297.60
1200 x 600mm	679	2317	300W	A, A+	86.0217	266.00	319.20
1800 x 500mm	907	3094	300W	A, A+	86.0222	353.00	423.60
1800 x 600mm	1088	3712	600W	A, A+	86.0223	382.00	458.40

### Pelago - Polished Aluminium

Size H x W	Watts	BTU	Element Output	Element Type	Code	£ Ex VAT	£ Inc VAT
600 x 500mm	287	981	150W	A, A+	86.0212	167.00	200.40
600 x 600mm	345	1177	150W	A, A+	86.0213	180.00	216.00
1200 x 500mm	549	1873	300W	A, A+	86.0218	277.00	332.40
1200 x 600mm	659	2248	300W	A, A+	86.0219	298.00	357.60
1800 x 500mm	880	3001	300W	A, A+	86.0224	396.00	475.20
1800 x 600mm	1055	3601	600W	A, A+	86.0225	430.00	516.00

### TECHNICAL INFORMATION

All measurements in Height by Width. Heat output based on  $\Delta T60^{\circ}C$ . Radiators that are electric only are restricted to the heat output of the elements. For element types see pages 288-300. For matching valves see pages 301-309. For indirect heating systems only. Tappings are approx. 25mm less than the width of the rail and approx. 75-105mm off the wall. Price includes radiator and wall fixing sets, valves extra.

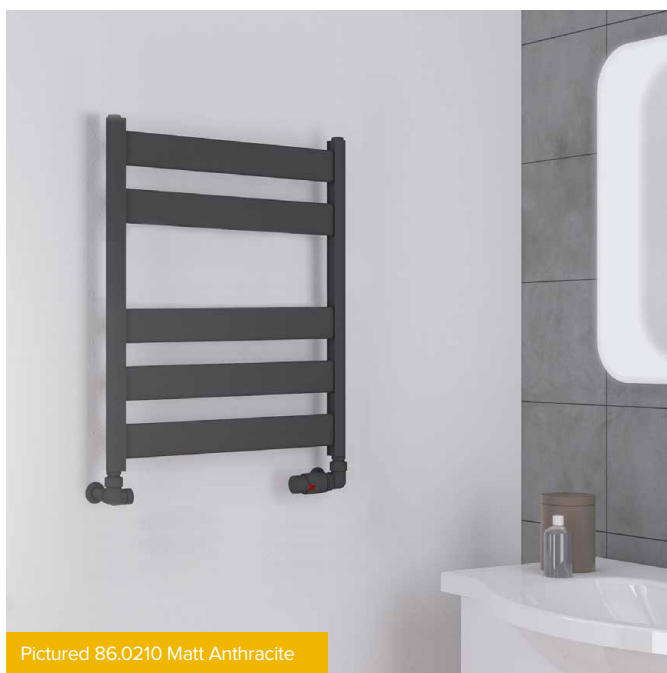

Pictured 86.0210 Matt Anthracite

Warranty

5

Year

Heating



All Electric



Dual-Fuel



# Aluminium Range

VELOR

High Output 



Pictured 86.0167 Matt Anthracite



Pictured 86.0163 Matt White

The Velor is light weight aluminium towel rail that has a high heat output. It's available in two colours; Matt White & Matt Anthracite, both with slanted horizontal bars.

**FEATURES**

- Excellent heat conductivity and lightweight
- Only requires a low water volume
- Heats up very quickly
- Tested to BS EN 442 standards
- 5 Year Manufacturer's Warranty\*
- Can be single or dual fuel, or all electric
- \* With conditions

**Technical Tables  
& Drawings**  
Page 362-363



Warranty

5

Year

Heating



All Electric



Dual-Fuel



**Velor Straight Towel Rail - Matt Anthracite**

Size H x W	Watts	BTU	Element Output	Element Type	Code	£ Ex VAT	£ Inc VAT
600 x 500mm	266	908	150W	A, D, E	86.0164	201.00	<b>241.20</b>
600 x 600mm	319	1090	150W	A, D, E	86.0165	218.00	<b>261.60</b>
1200 x 500mm	699	2384	300W	A, D, E	86.0166	398.00	<b>477.60</b>
1200 x 600mm	838	2861	300W	A, D, E	86.0167	441.00	<b>529.20</b>
1800 x 500mm	1031	3519	600W	A, D, E	86.0168	570.00	<b>684.00</b>
1800 x 600mm	1238	4223	600W	A, D, E	86.0169	639.00	<b>766.80</b>

**Velor Straight Towel Rail - Matt White**

Size H x W	Watts	BTU	Element Output	Element Type	Code	£ Ex VAT	£ Inc VAT
600 x 500mm	266	908	150W	A, D, E	86.0158	201.00	<b>241.20</b>
600 x 600mm	319	1090	150W	A, D, E	86.0159	218.00	<b>261.60</b>
1200 x 500mm	699	2384	300W	A, D, E	86.0160	398.00	<b>477.60</b>
1200 x 600mm	838	2861	300W	A, D, E	86.0161	441.00	<b>529.20</b>
1800 x 500mm	1031	3519	600W	A, D, E	86.0162	570.00	<b>684.00</b>
1800 x 600mm	1238	4223	600W	A, D, E	86.0163	639.00	<b>766.80</b>



Slanted Horizontal Bars



Exposed Chrome Cover Caps

**TECHNICAL INFORMATION**

All measurements in Height by Width. Heat output based on  $\Delta T60^{\circ}C$ . Radiators that are electric only are restricted to the heat output of the elements. Element size can be increased to full capacity of rail if using element type D or E. For element types see pages 288-300. For matching valves see pages 301-309. For indirect heating systems only. Tappings are approx. 25mm less than the width of the rail and approx. 80-110mm off the wall. Price includes radiator and wall fixing sets, valves extra.

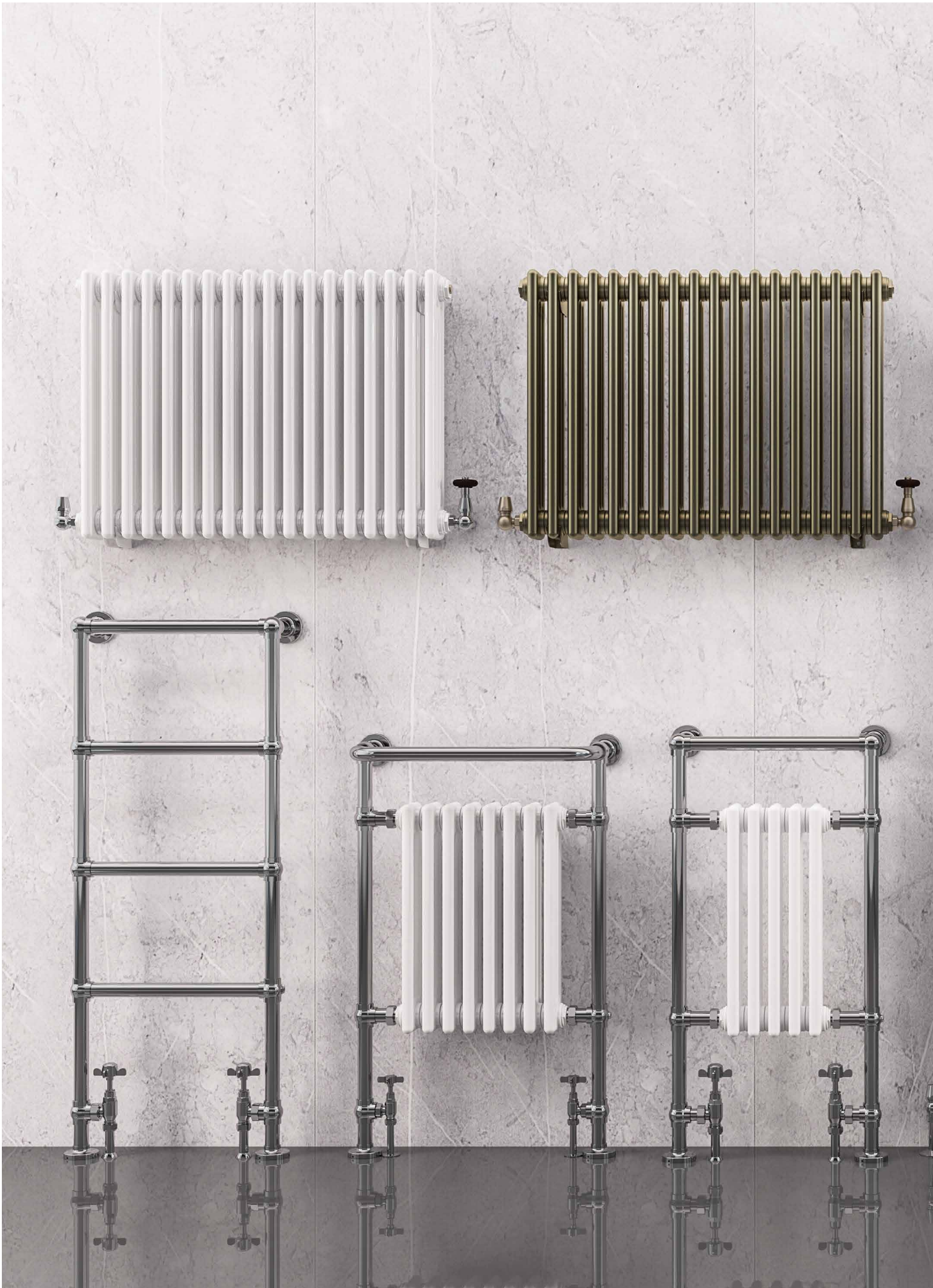

# Traditional Range

Our traditional range of radiators offer character and flair to ensure they fit in with your classic designs. Most of these radiators can be powered via dual fuel, single fuel and / or all electric.

## Contents

Windrush, Chrome	260
Stour, Available in 5 colours	261-263
Painswick, Chrome	264
Frome, Chrome	264
Sherbourne, Chrome	265
Avon, Available in 3 colours	266
Isbourne, Available in 3 colours - <b>NEW COLOUR</b>	267
Imperia 2 Column, Available in 3 colours	268-270
Imperia 3 Column, Available in 3 colours	271-273
Rivassa 2 Column, Available in 5 colours	274-277
Rivassa 3 Column, Available in 5 colours	278-281
Rivassa 4 Column, Available in 3 colours	282-283
Leadon, Chrome / Gloss White	284
Thames, Chrome / Gloss White	284
Coln, Chrome / Gloss White	285
Twyver, Chrome / Gloss White	285



# Traditional Range

## WINDRUSH

Pictured 41.1009 Chrome

Warranty

**5**  
Year

Heating



All Electric



Dual-Fuel



Pictured 41.1016 Chrome



Pictured 41.1014 Chrome



Our traditional range of radiators offer character and flair to ensure they fit in with your classic designs. The Windrush is a simple, traditional design that will add a vintage feel to your bathroom.

### Windrush - Chrome

Size H x W x D	Watts	BTU	Element Output	Element Type	Code	£ Ex VAT	£ Inc VAT
950 x 500 x 130mm	147	502	100W	A, A+	41.1009	323.00	<b>387.60</b>
950 x 600 x 130mm	163	556	100W	A, A+	41.1003	345.00	<b>414.00</b>
1195 x 500 x 130mm	236	805	150W	A, A+, E	41.1014	349.00	<b>418.80</b>
1195 x 600 x 130mm	258	880	150W	A, A+, E	41.1015	369.00	<b>442.80</b>
1550 x 500 x 130mm	290	989	150W	A, A+, E	41.1016	423.00	<b>507.60</b>
1550 x 600 x 130mm	322	1099	150W	A, A+, E	41.1017	441.00	<b>529.20</b>

### FEATURES

- Can be single, dual fuel or all electric
- Tested to BS EN 442 standards
- 5 Year Manufacturer's Warranty\*

\* With conditions

### TECHNICAL INFORMATION

All measurements in Height by Width. Heat output based on  $\Delta T60^{\circ}\text{C}$ . Radiators that are electric only are restricted to the heat output of the elements. Element size can be increased to full capacity of rail if using element type E. For element types see pages 288-300. For matching valves see pages 301-309. For indirect heating systems only. Tappings are approx. 130mm less than the width of the rail (144mm for 41.1009) and approx. 105mm off the wall. Price includes radiator and wall fixing sets, valves extra.

### Technical Tables & Drawings

Page 378-379



# Traditional Range

STOUR

Pictured 41.1018 Chrome

Warranty

5

Year

Heating



All Electric



Dual-Fuel

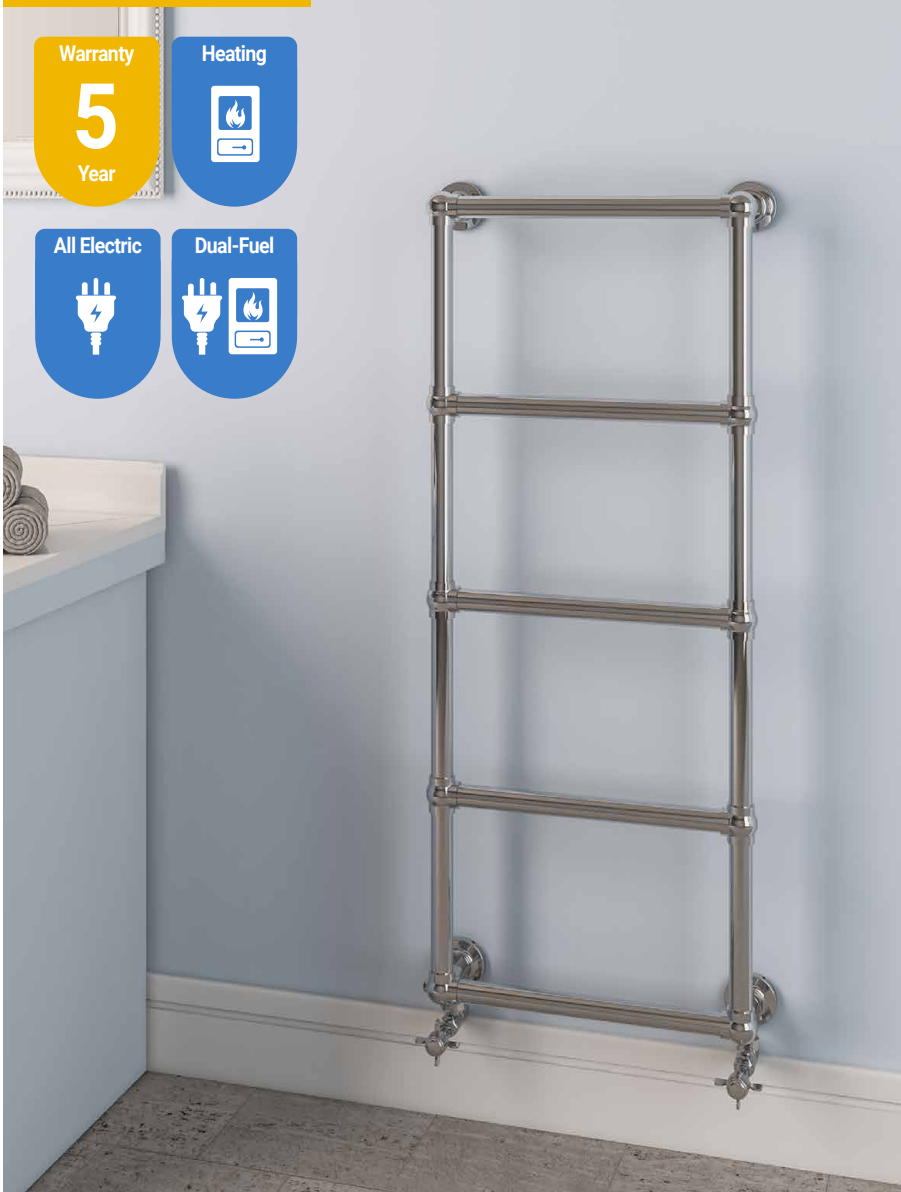

Pictured 41.1020 Chrome



Pictured 41.1018 Chrome



Pictured 41.1010 Chrome

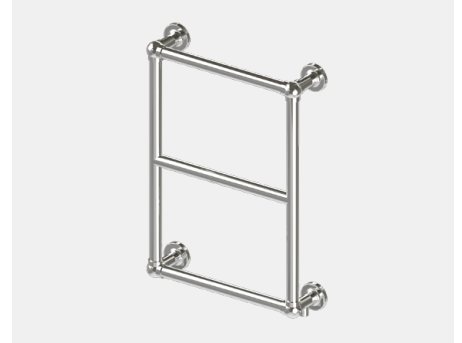

Our traditional range of radiators offer character and flair to ensure they fit in with your classic designs. The Stour in chrome finish offers a Victorian feel to complement a traditional bathroom.

## FEATURES

- Can be single, dual fuel or all electric
- Tested to BS EN 442 standards
- 5 Year Manufacturer's Warranty\*
- \* With conditions

## Technical Tables

### & Drawings

Page 378-379



## Stour - Chrome

Size H x W	Watts	BTU	Element Output	Element Type	Code	£ Ex VAT	£ Inc VAT
690 x 500mm	125	428	150W	A, A+, E	41.1010	242.00	290.40
690 x 600mm	177	604	100W	A, A+, E	41.1005	265.00	318.00
1195 x 500mm	209	714	100W	A, A+, E	41.1018	382.00	458.40
1195 x 600mm	232	791	150W	A, A+, E	41.1019	401.00	481.20
1550 x 500mm	260	888	150W	A, A+, E	41.1020	450.00	540.00
1550 x 600mm	287	980	150W	A, A+, E	41.1021	479.00	574.80

## TECHNICAL INFORMATION

All measurements in Height by Width. Heat output based on  $\Delta T60^{\circ}\text{C}$ . Radiators that are electric only are restricted to the heat output of the elements. Element size can be increased to full capacity of rail if using element type E. For element types see pages 288-300. For matching valves see pages 301-309. For indirect heating systems only. Tappings are approx. 74mm less than the width of the rail and approx. 53mm off the wall. Price includes radiator and wall fixing sets, valves extra.

# Traditional Range

## STOUR



Brushed Brass colour shown in images are subject to the limitations of the printing process and may appear different.

Pictured 41.0380 Brushed Brass



Pictured 41.0435 Matt White

Our traditional range of radiators offer character and flair to ensure they fit in with your classic designs. The Stour in new colours, brushed brass and matt white offers a Victorian feel to complement a traditional bathroom.

Stour - Brushed Brass							
Size H x W	Watts	BTU	Element Output	Element Type	Code	£ Ex VAT	£ Inc VAT
690 x 500mm	125	428	150W	A, A+, E	41.0377	373.00	447.60
690 x 600mm	177	604	100W	A, A+, E	41.0378	403.00	483.60
1195 x 500mm	209	714	100W	A, A+, E	41.0379	594.00	712.80
1195 x 600mm	232	791	150W	A, A+, E	41.0380	626.00	751.20
1550 x 500mm	260	888	150W	A, A+, E	41.0381	731.00	877.20
1550 x 600mm	287	980	150W	A, A+, E	41.0382	782.00	938.40

- FEATURES**
- Can be single, dual fuel or all electric
  - Tested to BS EN 442 standards
  - 5 Year Manufacturer's Warranty\*
- \* With conditions

**Technical Tables & Drawings**  
Page 378-379

Stour - Matt White							
Size H x W	Watts	BTU	Element Output	Element Type	Code	£ Ex VAT	£ Inc VAT
690 x 500mm	221	753	100W	A, A+, E	41.0431	207.00	248.40
690 x 600mm	240	820	100W	A, A+, E	41.0432	222.00	266.40
1195 x 500mm	287	979	100W	A, A+, E	41.0433	332.00	398.40
1195 x 600mm	386	1318	150W	A, A+, E	41.0434	354.00	424.80
1550 x 500mm	366	1248	150W	A, A+, E	41.0435	364.00	436.80
1550 x 600mm	398	1359	150W	A, A+, E	41.0436	395.00	474.00

### TECHNICAL INFORMATION

All measurements in Height by Width. Heat output based on  $\Delta T60^{\circ}\text{C}$ . Radiators that are electric only are restricted to the heat output of the elements. Element size can be increased to full capacity of rail if using element type E. For element types see pages 288-300. For matching valves see pages 301-309. For indirect heating systems only. Tappings are approx. 74mm less than the width of the rail and approx. 53mm off the wall. Price includes radiator and wall fixing sets, valves extra.

Warranty

5

Year

Heating

All Electric

Dual-Fuel



# Traditional Range

STOUR



Pictured 41.0437 Matt Anthracite



Pictured 41.0445 Matt Black

Our traditional range of radiators offer character and flair to ensure they fit in with your classic designs. The Stour in new colours, matt anthracite and matt black offers a Victorian feel to complement a traditional bathroom.

**FEATURES**

- Can be single, dual fuel or all electric
- Tested to BS EN 442 standards
- 5 Year Manufacturer's Warranty\*
- \* With conditions

**Technical Tables & Drawings**  
Page 378-379



**Stour - Matt Anthracite**

Size H x W	Watts	BTU	Element Output	Element Type	Code	£ Ex VAT	£ Inc VAT
690 x 500mm	221	753	100W	A, A+, E	41.0437	207.00	<b>248.40</b>
690 x 600mm	240	820	100W	A, A+, E	41.0438	222.00	<b>266.40</b>
1195 x 500mm	287	979	100W	A, A+, E	41.0439	332.00	<b>398.40</b>
1195 x 600mm	386	1318	150W	A, A+, E	41.0440	354.00	<b>424.80</b>
1550 x 500mm	366	1248	150W	A, A+, E	41.0441	364.00	<b>436.80</b>
1550 x 600mm	398	1359	150W	A, A+, E	41.0442	395.00	<b>474.00</b>

**Stour - Matt Black**

Size H x W	Watts	BTU	Element Output	Element Type	Code	£ Ex VAT	£ Inc VAT
690 x 500mm	221	753	100W	A, A+, E	41.0443	207.00	<b>248.40</b>
690 x 600mm	240	820	100W	A, A+, E	41.0444	222.00	<b>266.40</b>
1195 x 500mm	287	979	100W	A, A+, E	41.0445	332.00	<b>398.40</b>
1195 x 600mm	386	1318	150W	A, A+, E	41.0446	354.00	<b>424.80</b>
1550 x 500mm	366	1248	150W	A, A+, E	41.0447	364.00	<b>436.80</b>
1550 x 600mm	398	1359	150W	A, A+, E	41.0448	395.00	<b>474.00</b>

**TECHNICAL INFORMATION**

All measurements in Height by Width. Heat output based on  $\Delta T60^{\circ}C$ . Radiators that are electric only are restricted to the heat output of the elements. Element size can be increased to full capacity of rail if using element type E. For element types see pages 288-300. For matching valves see pages 301-309. For indirect heating systems only. Tappings are approx. 74mm less than the width of the rail and approx. 53mm off the wall. Price includes radiator and wall fixing sets, valves extra.

Warranty

**5**

Year

Heating

All Electric

Dual-Fuel

# Traditional Range

## PAINSWICK



Our traditional range of radiators offer character and flair to ensure they fit in with your classic designs. The Painswick is a stunning classical radiator with elegant practical curves.

### Painswick - Chrome

Size H x W	Watts	BTU	Element Output	Element Type	Code	£ Ex VAT	£ Inc VAT
778 x 686mm	356	1215	N/A	N/A	41.1022	859.00	1030.80

Tappings are approx. 130mm less than the width of the rail and approx. 105mm off the wall.

### FEATURES

- Tested to BS EN 442 standards
- 5 Year Manufacturer's Warranty\*
- Not suitable for elements
- \* With conditions

### Technical Tables & Drawings

Page 380-381



### TECHNICAL INFORMATION

All measurements in Height by Width. Heat output based on  $\Delta T60^{\circ}\text{C}$ . For matching valves see pages 301-309. For indirect heating systems only. Tappings are approx. 130mm less than the width of the rail and approx. 100mm off the floor. Price includes radiator and wall fixing sets, valves extra.

5

Warranty

Heating



### Pair of Radiator Valves & Tails

Code	£ Ex VAT	£ Inc VAT
54.0001	54.00	64.80

Radiator valves sold separately

## FROME



Our traditional range of radiators offer character and flair to ensure they fit in with your classic designs. These rails only be used on closed or indirect heating circuits, not on fresh water hot systems as they are of steel construction.

### Frome - Chrome

Size H x W	Watts	BTU	Element Output	Element Type	Code	£ Ex VAT	£ Inc VAT
940 x 474mm	314	1071	150W	A, A+, C, E, H	41.1013	441.00	529.20

Tappings are approx. 130mm less than the width of the rail and approx. 105mm off the wall.

### FEATURES

- Tested to BS EN 442 standards.
- 5 Year Manufacturer's Warranty\*
- Can be single or dual fuel, or all electric
- \* With conditions

### Technical Tables & Drawings

Page 380-381



### TECHNICAL INFORMATION

All measurements in Height by Width. Heat output based on  $\Delta T60^{\circ}\text{C}$ . Radiators that are electric only are restricted to the heat output of the elements. Element size can be increased to full capacity of rail if using element type C, E or H. For element types see pages 288-300. For matching valves see pages 301-309. For indirect heating systems. Prices include radiator and wall fixings sets, valves extra.

5

Warranty

Heating



### Pair of Radiator Valves & Tails

Code	£ Ex VAT	£ Inc VAT
54.0001	54.00	64.80

Radiator valves sold separately

All Electric

Dual-Fuel

# Traditional Range

## SHERBOURNE

For element types see pages 288-300.



Our traditional range of radiators offer character and flair to ensure they fit in with your classic designs. These rails only be used on closed or indirect heating circuits, not on fresh water hot systems as they are of steel construction.

### Sherbourne - Chrome

Size H x W x D	Watts	BTU	Element Output	Element Type	Code	£ Ex VAT	£ Inc VAT
960 x 600 x 142mm	226	771	150W	A, A+, C, E, H	41.1001	418.00	501.60

Tappings are approx. 130mm less than the width of the rail and approx. 105mm off the wall.

### FEATURES

- Tested to BS EN 442 standards.
- 5 Year Manufacturer's Warranty\*
- Can be single or dual fuel, or all electric
- \* With conditions

### Technical Tables & Drawings

Page 380-381



### TECHNICAL INFORMATION

All measurements in Height by Width. Heat output based on  $\Delta T60^{\circ}\text{C}$ . Radiators that are electric only are restricted to the heat output of the elements. Element size can be increased to full capacity of rail if using element type C, E or H. For element types see pages 288-300. For matching valves see pages 301-309. For indirect heating systems. Prices include radiator and wall fixings sets, valves extra.

Warranty

# 5

Year

Heating

All Electric

Dual-Fuel

Pair of Radiator Valves & Tails		
Code	£ Ex VAT	£ Inc VAT
54.0001	54.00	64.80

Radiator valves sold separately

## CLEARANCE ITEM

## AMPNEY

For element types see pages 288-300.



Our traditional range of radiators offer character and flair to ensure they fit in with your classic designs. These rails only be used on closed or indirect heating circuits, not on fresh water hot systems as they are of steel construction.

### Ampney - Chrome

### CLEARANCE ITEM

Size H x W	Watts	BTU	Element Output	Element Type	Code	£ Ex VAT	£ Inc VAT
940 x 674mm*	423	1443	150W	A, A+, C, E, H	41.1012	363.00	435.60

Tappings are approx. 130mm less than the width of the rail and approx. 105mm off the wall.

### FEATURES

- Tested to BS EN 442 standards.
- 5 Year Manufacturer's Warranty\*
- Can be single or dual fuel, or all electric
- \* With conditions

### TECHNICAL INFORMATION

All measurements in Height by Width. Heat output based on  $\Delta T60^{\circ}\text{C}$ . Radiators that are electric only are restricted to the heat output of the elements. Element size can be increased to full capacity of rail if using element type C, E or H. For element types see pages 288-300. For matching valves see pages 301-309. For indirect heating systems. Prices include radiator and wall fixings sets, valves extra.

Warranty

# 5

Year

Heating

All Electric

Dual-Fuel

Pair of Radiator Valves & Tails		
Code	£ Ex VAT	£ Inc VAT
54.0001	54.00	64.80

Radiator valves sold separately

# Traditional Range

## AVON

For element types see pages 288-300.



Pictured 41.1006 Chrome / Gloss White

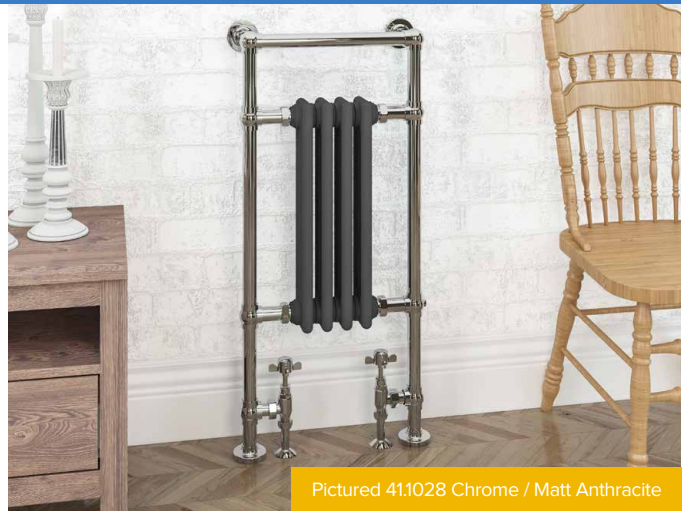

Pictured 41.1028 Chrome / Matt Anthracite



Pictured 41.1026 Chrome / Matt Black

Our traditional range of radiators offer character and flair to ensure they fit in with your classic designs. These rails only be used on closed or indirect heating circuits, not on fresh water hot systems as they are of steel construction.

Avon - Chrome / Gloss White							
Size H x W x D	Watts	BTU	Element Output	Element Type	Code	£ Ex VAT	£ Inc VAT
960 x 429 x 185mm	450	1535	150W	A, A+, C, E, H	41.1027	385.00	462.00
960 x 500 x 185mm	530	1808	300W	A, A+, C, E, H	41.1006	408.00	489.60

Avon - Chrome / Matt Anthracite							
Size H x W x D	Watts	BTU	Element Output	Element Type	Code	£ Ex VAT	£ Inc VAT
960 x 429 x 185mm	450	1535	150W	A, A+, C, E, H	41.1028	385.00	462.00
960 x 500 x 185mm	530	1808	300W	A, A+, C, E, H	41.1025	408.00	489.60

Avon - Chrome / Matt Black							
Size H x W x D	Watts	BTU	Element Output	Element Type	Code	£ Ex VAT	£ Inc VAT
960 x 429 x 185mm	450	1535	150W	A, A+, C, E, H	41.1029	385.00	462.00
960 x 500 x 185mm	530	1808	300W	A, A+, C, E, H	41.1026	408.00	489.60

Tappings are approx. 130mm less than the width of the rail and approx. 135mm off the wall.

### FEATURES

- Tested to BS EN 442 standards
- 5 Year Manufacturer's Warranty\*
- Can be single or dual fuel, or all electric
- \* With conditions

Technical Tables & Drawings  
Page 380-381



### TECHNICAL INFORMATION

All measurements in Height by Width. Heat output based on  $\Delta T60^{\circ}\text{C}$ . Radiators that are electric only are restricted to the heat output of the elements. Element size can be increased to full capacity of rail if using element type C, E or H. For element types see pages 288-300. For matching valves see pages 301-309. For indirect heating systems. Tappings from wall 135mm. Projection from wall 185mm. Prices include radiator and wall fixings sets, valves extra.

Warranty

5

Year

Heating

All Electric

Dual-Fuel



Pair of Radiator Valves & Tails		
Code	£ Ex VAT	£ Inc VAT
54.0001	54.00	64.80

Radiator valves sold separately

### COMPLETE THE LOOK

Angle TRV with Lockshield 15mm (pair) Chrome

Code	£ Ex VAT	£ Inc VAT
54.0008	90.00	108.00



# Traditional Range

ISBOURNE

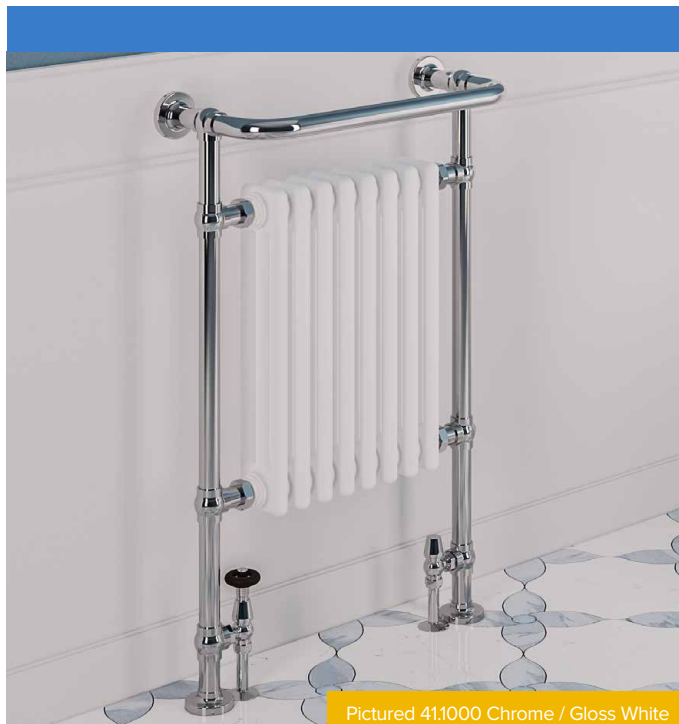

Pictured 41.1000 Chrome / Gloss White

Isbourne - Chrome / Gloss White

Size H x W	Watts	BTU	Element Output	Element Type	Code	£ Ex VAT	£ Inc VAT
940 x 600	894	3050	450W	A, A+, C, H	41.1000	476.00	571.20

Due in November 2023



Pictured 41.0709 Brushed Brass / Gloss White

NEW! Isbourne - Brushed Brass / Gloss White

Size H x W	Watts	BTU	Element Output	Element Type	Code	£ Ex VAT	£ Inc VAT
940 x 600	894	3050	450W	A, A+, C, H	41.0709	687.00	824.40

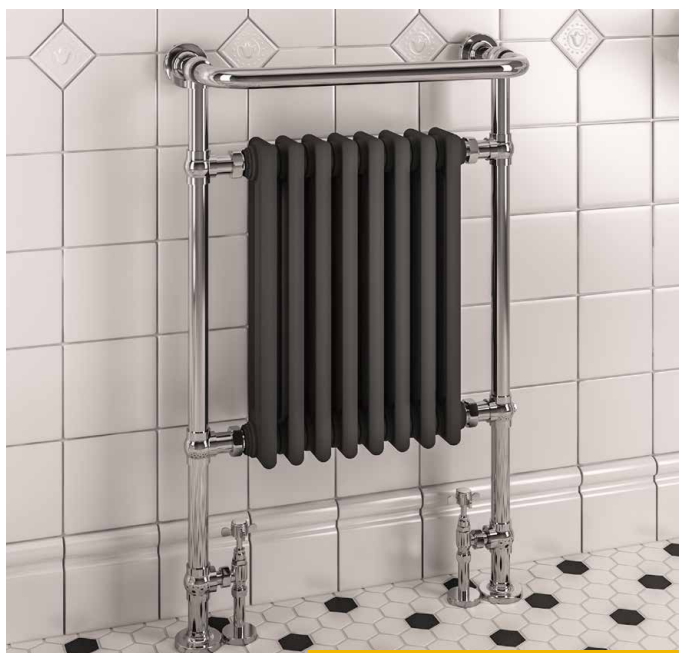

Pictured 41.1024 Chrome / Matt Anthracite

Isbourne - Chrome / Matt Anthracite

Size H x W	Watts	BTU	Element Output	Element Type	Code	£ Ex VAT	£ Inc VAT
940 x 600	894	3050	450W	A, A+, C, H	41.1024	476.00	571.20

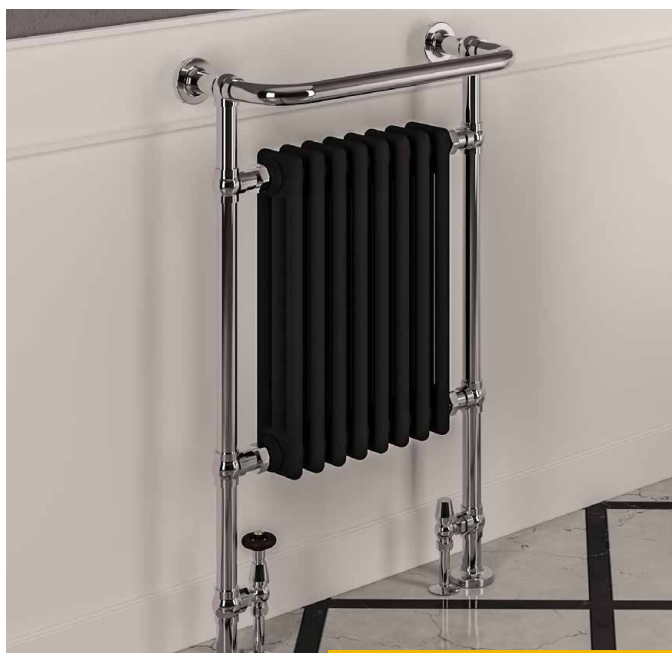

Pictured 41.1023 Chrome / Matt Black

Isbourne - Chrome / Matt Black

Size H x W	Watts	BTU	Element Output	Element Type	Code	£ Ex VAT	£ Inc VAT
940 x 600	894	3050	450W	A, A+, C, H	41.1023	476.00	571.20

Our traditional range of radiators offer character and flair to ensure they fit in with your classic designs. These rails only be used on closed or indirect heating circuits, not on fresh water hot systems as they are of steel construction.

Warranty

# 5

Year

Heating

All Electric

Dual-Fuel

### FEATURES

- Tested to BS EN 442 standards
- 5 Year Manufacturer's Warranty\*
- Can be single or dual fuel, or all electric
- \* With conditions

Technical Tables & Drawings

Page 380-381



### TECHNICAL INFORMATION

All measurements in Height by Width. Heat output based on  $\Delta T60^{\circ}C$ . Radiators that are electric only are restricted to the heat output of the elements. Element size can be increased to full capacity of rail if using element type C or H. For element types see pages 288-300. For matching valves see pages 301-309. For indirect heating systems. Tappings from wall approx 121mm. Projection from wall 260mm. Prices include radiator and wall fixings sets, valves extra.

# Traditional Range

## IMPERIA 2 COLUMN



Pictured 41.0345 Matt Anthracite

A traditional rail which will give a Victorian touch of authenticity to any room but will also create an elegant look to a contemporary interior. This radiator boasts high outputs to ensure the whole room is warm. Comes with the option of traditional legs and in gloss white, matt anthracite or bare metal finishes. Also available in three columns.

### FEATURES

- Tested to BS EN 442 standards
- 5 Year Manufacturer's Warranty\*
- Matching colour wall fixing sets
- Radiator feet option available to get the classic look
- Material thickness 1.5mm
- Doesn't require flow diverter
- \* With conditions

**Technical Tables & Drawings**  
Page 382-383



### Traditional TRVs

Page 304



Pictured 41.0342 Matt Anthracite with 41.0358 feet

### Dual Fuel installation



Pictured 41.0339 Gloss White with 8.560 Type H Wi-Fi element, 54.0007 TRV, 8.901 T piece and 41.3003 elbow

Warranty

5  
Year

Heating



All Electric



Dual-Fuel

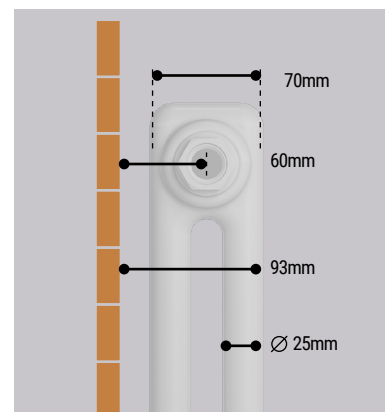

# Traditional Range

## IMPERIA 2 COLUMN

### Imperia Two Column Radiators - Gloss White

Size H x W	Watts	BTU	Element Output	Element Type	Code	£ Ex VAT	£ Inc VAT
300 x 1145mm	875	2985	450W	A, A+, C, E*, H	41.0383	288.00	345.60
300 x 1370mm	1048	3573	450W	A, A+, C, E*, H	41.0384	340.00	408.00
600 x 425mm	576	1965	300W	A, A+, C, H	41.0385	158.00	189.60
600 x 470mm	639	2180	300W	A, A+, C, H	41.0386	172.00	206.40
600 x 515mm	704	2402	300W	A, A+, C, H	41.0387	185.00	222.00
600 x 560mm	767	2617	300W	A, A+, C, H	41.0388	200.00	240.00
600 x 605mm	826	2818	450W	A, A+, C, H	41.0339	236.00	283.20
600 x 830mm	1143	3900	600W	A, A+, C, E*, H	41.0338	310.00	372.00
600 x 1010mm	1407	4800	750W	A, A+, C, H	41.0389	338.00	405.60
600 x 1145mm	1588	5418	900W	A, A+, H	41.0337	415.00	498.00
600 x 1460mm	2046	6980	1000W	A+	41.0390	476.00	571.20
1800 x 290mm	1078	3678	N/A	N/A	41.0391	227.00	272.40
1800 x 380mm	1190	4059	N/A	N/A	41.0341	296.00	355.20
1800 x 470mm	1487	5074	N/A	N/A	41.0340	356.00	427.20

\*600w Type E Element can be fitted

### Imperia Two Column Radiators - Matt Anthracite

Size H x W	Watts	BTU	Element Output	Element Type	Code	£ Ex VAT	£ Inc VAT
300 x 1145mm	875	2985	450W	A, A+, C, E*, H	41.0392	288.00	345.60
300 x 1370mm	1048	3573	450W	A, A+, C, E*, H	41.0393	340.00	408.00
600 x 425mm	576	1965	300W	A, A+, C, H	41.0394	158.00	189.60
600 x 470mm	639	2180	300W	A, A+, C, H	41.0395	172.00	206.40
600 x 515mm	704	2402	300W	A, A+, C, H	41.0396	185.00	222.00
600 x 560mm	767	2617	300W	A, A+, C, H	41.0397	200.00	240.00
600 x 605mm	826	2818	450W	A, A+, C, H	41.0344	236.00	283.20
600 x 830mm	1143	3900	600W	A, A+, C, E*, H	41.0343	310.00	372.00
600 x 1010mm	1407	4800	750W	A, A+, C, H	41.0398	338.00	405.60
600 x 1145mm	1588	5418	900W	A, A+, H	41.0342	415.00	498.00
600 x 1460mm	2046	6980	1000W	A+	41.0399	476.00	571.20
1800 x 290mm	1078	3678	N/A	N/A	41.0400	227.00	272.40
1800 x 380mm	1190	4059	N/A	N/A	41.0346	296.00	355.20
1800 x 470mm	1487	5074	N/A	N/A	41.0345	356.00	427.20

\*600w Type E Element can be fitted

### TECHNICAL INFORMATION

All measurements in Height by Width. Heat output based on  $\Delta T60^{\circ}\text{C}$ . Radiators that are electric only are restricted to the heat output of the elements. Element size can be increased to full capacity of rail if using element type C, E or H. For element types see pages 288-300. For matching valves see pages 301-309. For indirect heating systems. Tappings are the width of the rail and 60mm off the wall. Prices include radiator and wall fixings sets, valves extra.

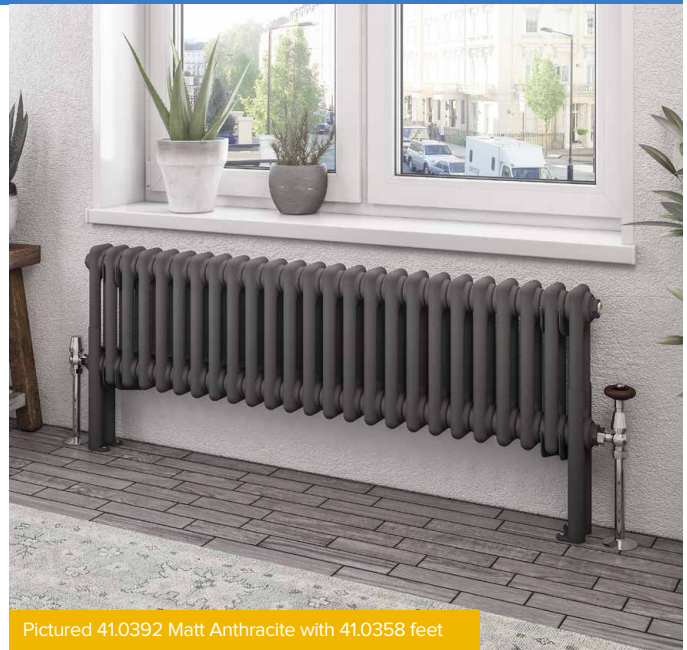

Pictured 41.0392 Matt Anthracite with 41.0358 feet



### Imperia Radiator Feet

Description	Code	£ Ex VAT	£ Inc VAT
Imperia 2 Column Radiator Feet (pair) Gloss White	41.0357	35.00	42.00
Imperia 2 Column Radiator Feet (pair) Matt Anthracite	41.0358	35.00	42.00



Pictured 41.0337 Gloss White with Type A+ Element

### Imperia Towel Hangers

Page 310



### Robe Hooks

Page 310

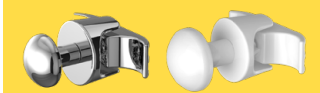

### Round Vent Caps

Page 313



# Traditional Range

## IMPERIA 2 COLUMN, BARE METAL



Pictured 41.0422 Bare Metal

Imperia bare metal radiators are handfinished therefore each radiator will have its own unique welding marks and imperfections that are left on purpose. Bare Metal colour shown in images are subject to the limitations of the printing process and may appear different.

**Traditional TRVs**  
Page 304

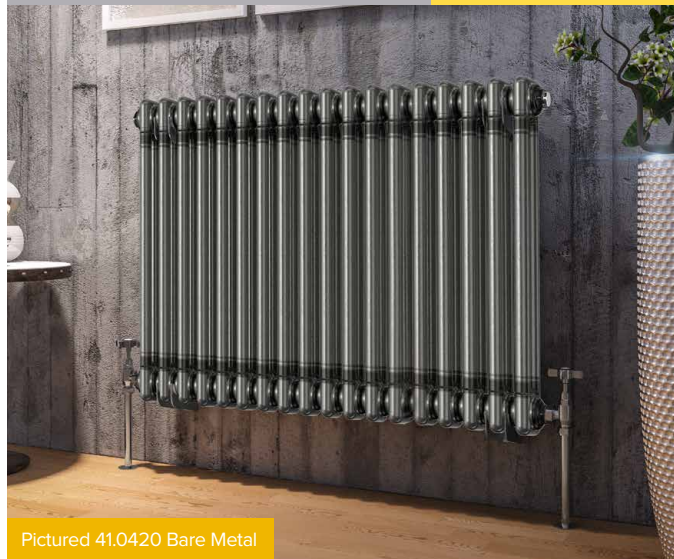

Pictured 41.0420 Bare Metal

### FEATURES

- Tested to BS EN 442 standards
- 5 Year Manufacturer's Warranty\*
- Matching colour wall fixing sets
- Radiator feet option available to get the classic look
- Material thickness 1.5mm
- Doesn't require flow diverter
- \* With conditions

**Technical Tables & Drawings**  
Page 382-383



### Imperia Two Column Radiators - Bare Metal

Size H x W	Watts	BTU	Element Output	Element Type	Code	£ Ex VAT	£ Inc VAT
600 x 605mm	826	2818	450W	A, A+, C, H	41.0419	334.00	400.80
600 x 830mm	1143	3900	600W	A, A+, C, E*, H	41.0420	444.00	532.80
600 x 1145mm	1588	5418	900W	A, A+, H	41.0421	595.00	714.00
1800 x 380mm	1190	4059	N/A	N/A	41.0422	446.00	535.20
1800 x 470mm	1487	5074	N/A	N/A	41.0423	532.00	638.40

\*600w Type E Element can be fitted

### TECHNICAL INFORMATION

All measurements in Height by Width. Heat output based on  $\Delta T60^{\circ}C$ . Radiators that are electric only are restricted to the heat output of the elements. Element size can be increased to full capacity of rail if using element type C, E or H. For element types see pages 288-300. For matching valves see pages 301-309. For indirect heating systems. Tappings are the width of the rail and 60mm off the wall. Prices include radiator and wall fixings sets, valves extra.

Eastbrook is always on the look out for products and finishes trending in the UK market. We have noticed a trend in bare brick and plain painted walls with traditional engineering items such as small sand casts mounted on the wall. Known in designer circles as the Industrial Chic look.

For those of you looking for Bare metal finish radiator showing the welds, pressings, sanding and tubes that make up a traditional column radiator we have introduced this range. We have sealed the metal with clear lacquer to ensure no impurities are allow to discolour of oxidise the metal.

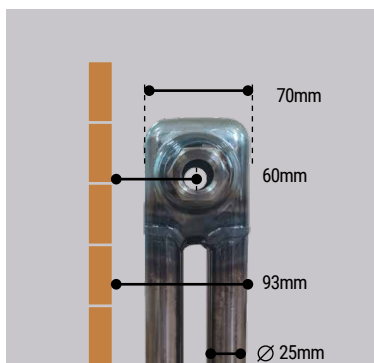

Warranty

# 5

Year

Heating

All Electric

Dual-Fuel



### Imperia Radiator Feet

Description	Code	£ Ex VAT	£ Inc VAT
Imperia 2 Column Radiator Feet (pair)	41.0429	45.00	54.00



# Traditional Range

## IMPERIA 3 COLUMN, BARE METAL



Pictured 41.0428 Bare Metal

Imperia bare metal radiators are handfinished therefore each radiator will have its own unique welding marks and imperfections that are left on purpose. Bare Metal colour shown in images are subject to the limitations of the printing process and may appear different.

**Traditional TRVs**  
Page 304



Pictured 41.0424 Bare Metal

### FEATURES

- Tested to BS EN 442 standards
- 5 Year Manufacturer's Warranty\*
- Matching colour wall fixing sets
- Radiator feet option available to get the classic look
- Material thickness 1.5mmv
- Doesn't require flow diverter
- \* With conditions

**Technical Tables & Drawings**  
Page 382-383



### Imperia Three Column Radiators - Bare Metal

Size H x W	Watts	BTU	Element Output	Element Type	Code	£ Ex VAT	£ Inc VAT
600 x 605mm	1081	3688	600W	A, A+, C, H	41.0424	393.00	471.60
600 x 830mm	1498	5110	900W	A+, C, H	41.0425	522.00	626.40
600 x 1145mm	2362	8059	1200W	A, A+, H	41.0426	702.00	842.40
1800 x 380mm	2099	7160	N/A	N/A	41.0427	537.00	644.40
1800 x 470mm	2623	8950	N/A	N/A	41.0428	641.00	769.20

### TECHNICAL INFORMATION

All measurements in Height by Width. Heat output based on  $\Delta T60^{\circ}C$ . Radiators that are electric only are restricted to the heat output of the elements. Element size can be increased to full capacity of rail if using element type C, E or H. For element types see pages 288-300. For matching valves see pages 301-309. For indirect heating systems. Tappings are the width of the rail and 72mm off the wall. Prices include radiator and wall fixings sets, valves extra.

Eastbrook is always on the look out for products and finishes trending in the UK market. We have noticed a trend in bare brick and plain painted walls with traditional engineering items such as small sand casts mounted on the wall. Known in designer circles as the Industrial Chic look.

For those of you looking for Bare metal finish radiator showing the welds, pressings, sanding and tubes that make up a traditional column radiator we have introduced this range. We have sealed the metal with clear lacquer to ensure no impurities are allow to discolour of oxidise the metal.

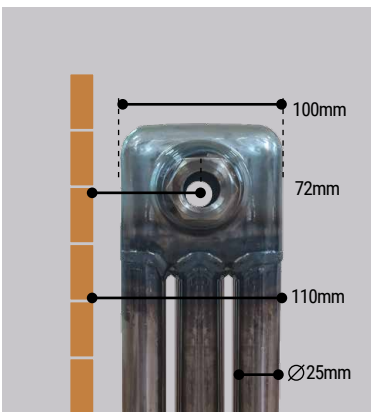

Warranty

# 5

Year

Heating

All Electric

Dual-Fuel



### Imperia Radiator Feet

Description	Code	£ Ex VAT	£ Inc VAT
Imperia 3 Column Radiator Feet (pair)	41.0430	49.00	58.80

# Traditional Range

## IMPERIA 3 COLUMN



Pictured 41.0351 Gloss White with 41.0359 feet

A traditional rail which will give a Victorian touch of authenticity to any room but will also create an elegant look to a contemporary interior. This radiator boasts high outputs to ensure the whole room is warm. Comes with the option of traditional legs and in gloss white, matt anthracite or bare metal finishes. Also available in two columns.

### FEATURES

- Tested to BS EN 442 standards
- 5 Year Manufacturer's Warranty\*
- Matching colour wall fixing sets
- Radiator feet option available to get the classic look
- Material thickness 1.5mm
- Doesn't require flow diverter
- \* With conditions

**Technical Tables & Drawings**  
Page 382-383



**Traditional TRVs**  
Page 304



Pictured 41.0353 Matt Anthracite



Pictured 41.0347 Gloss White

Warranty

5  
Year

Heating



All Electric



Dual-Fuel

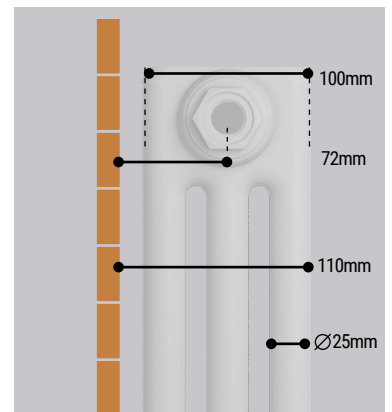

# Traditional Range

## IMPERIA 3 COLUMN

### Imperia Three Column Radiators - Gloss White

Size H x W	Watts	BTU	Element Output	Element Type	Code	£ Ex VAT	£ Inc VAT
300 x 1145mm	1278	4360	600W	A, A+, C, E*, H	41.0401	333.00	<b>399.60</b>
300 x 1370mm	1436	4896	750W	A, A+, C, E*, H	41.0402	393.00	<b>471.60</b>
600 x 425mm	850	2900	450W	A, A+	41.0403	187.00	<b>224.40</b>
600 x 470mm	945	3224	450W	A, A+, C, H	41.0404	203.00	<b>243.60</b>
600 x 515mm	1040	3548	450W	A, A+, C, H	41.0405	219.00	<b>262.80</b>
600 x 560mm	1134	3869	600W	A+, C, H	41.0406	237.00	<b>284.40</b>
600 x 605mm	1081	3688	600W	A, A+, C, H	41.0349	276.00	<b>331.20</b>
600 x 830mm	1498	5110	900W	A+, C, H	41.0348	364.00	<b>436.80</b>
600 x 1010mm	2079	7093	1000W	A, A+, C, H	41.0407	401.00	<b>481.20</b>
600 x 1145mm	2362	8059	1200W	A, A+, H	41.0347	490.00	<b>588.00</b>
600 x 1460mm	3024	10317	1200W	A+, H	41.0408	565.00	<b>678.00</b>
1800 x 290mm	1608	5486	N/A	N/A	41.0409	276.00	<b>331.20</b>
1800 x 380mm	2099	7160	N/A	N/A	41.0351	356.00	<b>427.20</b>
1800 x 470mm	2623	8950	N/A	N/A	41.0350	428.00	<b>513.60</b>

\*600w Type E Element can be fitted

### Imperia Three Column Radiators - Matt Anthracite

Size H x W	Watts	BTU	Element Output	Element Type	Code	£ Ex VAT	£ Inc VAT
300 x 1145mm	1278	4360	600W	A, A+, C, E*, H	41.0410	333.00	<b>399.60</b>
300 x 1370mm	1436	4896	750W	A, A+, C, E*, H	41.0411	393.00	<b>471.60</b>
600 x 425mm	850	2900	450W	A, A+	41.0412	187.00	<b>224.40</b>
600 x 470mm	945	3224	450W	A, A+, C, H	41.0413	203.00	<b>243.60</b>
600 x 515mm	1040	3548	450W	A, A+, C, H	41.0414	219.00	<b>262.80</b>
600 x 560mm	1134	3869	600W	A+, C, H	41.0415	237.00	<b>284.40</b>
600 x 605mm	1081	3688	600W	A, A+, C, H	41.0354	276.00	<b>331.20</b>
600 x 830mm	1498	5110	900W	A+, C, H	41.0353	364.00	<b>436.80</b>
600 x 1010mm	2079	7093	1000W	A, A+, C, H	41.0416	401.00	<b>481.20</b>
600 x 1145mm	2362	8059	1200W	A, A+, H	41.0352	490.00	<b>588.00</b>
600 x 1460mm	3024	10317	1200W	A+, H	41.0417	565.00	<b>678.00</b>
1800 x 290mm	1608	5486	N/A	N/A	41.0418	276.00	<b>331.20</b>
1800 x 380mm	2099	7160	N/A	N/A	41.0356	356.00	<b>427.20</b>
1800 x 470mm	2623	8950	N/A	N/A	41.0355	428.00	<b>513.60</b>

\*600w Type E Element can be fitted

### TECHNICAL INFORMATION

All measurements in Height by Width. Heat output based on  $\Delta T60^{\circ}\text{C}$ . Radiators that are electric only are restricted to the heat output of the elements. Element size can be increased to full capacity of rail if using element type C, E or H. For element types see pages 288-300. For matching valves see pages 301-309. For indirect heating systems. Tappings are the width of the rail and 72mm off the wall. Prices include radiator and wall fixings sets, valves extra.



Pictured 41.0411 Matt Anthracite



### Imperia Radiator Feet

Description	Code	£ Ex VAT	£ Inc VAT
Imperia 3 Column Radiator Feet (pair) Gloss White	41.0359	38.00	<b>45.60</b>
Imperia 3 Column Radiator Feet (pair) Matt Anthracite	41.0360	38.00	<b>45.60</b>

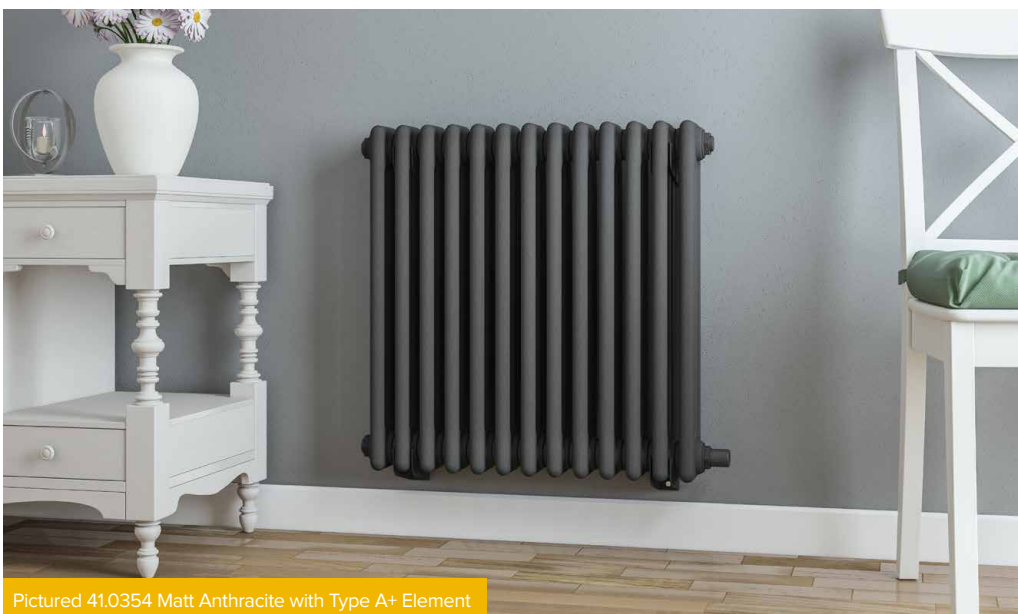

Pictured 41.0354 Matt Anthracite with Type A+ Element

### Imperia Towel Hangers

Page 310



### Robe Hooks

Page 310

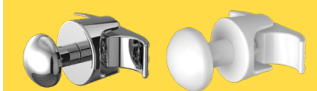

### Round Vent Caps

Page 313



# Traditional Range

## RIVASSA 2 COLUMN



Pictured 81.0003 Gloss White



Traditional TRVs  
Page 304



Pictured 81.0025 Matt Anthracite



Pictured 81.0008 Gloss White with 81.0034 Feet and 8.541 Type H element

A traditional rail which will give a Victorian touch of authenticity to any room but will also create an elegant look to a contemporary interior. This radiator boasts high outputs to ensure the whole room is warm. Comes with the option of traditional legs and in gloss white, matt anthracite or matt black finishes. Also available in three and four columns.

### FEATURES

- Tested to BS EN 442 standards
- 5 Year Manufacturer's Warranty\*
- Matching colour wall fixing sets
- 300mm height option for limited spaces
- Radiator feet option available to get the classic look
- Material thickness 1.5mm
- Doesn't require flow diverter
- \* With conditions

Technical Tables  
& Drawings  
Page 384-385



Warranty

5  
Year

Heating



All Electric



Dual-Fuel

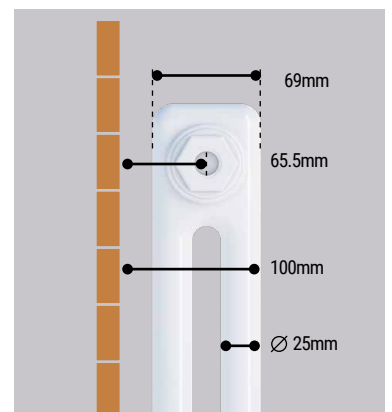

# Traditional Range

## RIVASSA 2 COLUMN

### Rivassa Two Column Radiators - Gloss White

Size H x W	Watts	BTU	Element Output	Element Type	Code	£ Ex VAT	£ Inc VAT
300 x 1148mm	889	3034	450W	A, A+, C, E*, H	81.0005	466.00	559.20
300 x 1373mm	1067	3641	600W	A, A+, C, E*, H	81.0006	558.00	669.60
600 x 428mm	567	1933	300W	A, A+, C, H	81.0038	213.00	255.60
600 x 473mm	630	2148	300W	A, A+, C, H	81.0039	237.00	284.40
600 x 518mm	693	2362	300W	A, A+, C, H	81.0040	259.00	310.80
600 x 563mm	756	2577	450W	A, A+, C, H	81.0041	284.00	340.80
600 x 608mm	818	2792	450W	A, A+, C, H	81.0007	308.00	369.60
600 x 833mm	1133	3866	600W	A, A+, C, E*, H	81.0008	427.00	512.40
600 x 1010mm	1385	4727	750W	A, A+, C, H	81.0077	522.00	626.40
600 x 1148mm	1573	5369	900W	A, A+, H	81.0009	593.00	711.60
600 x 1460mm	2014	6874	1200W	A, A+, H	81.0078	760.00	912.00
1800 x 293mm	933	3185	N/A	N/A	81.0002	277.00	332.40
1800 x 383mm	1245	4247	N/A	N/A	81.0003	364.00	436.80
1800 x 473mm	1556	5308	N/A	N/A	81.0004	456.00	547.20

\*600w Type E Element can be fitted

### Rivassa Two Column Radiators - Matt Anthracite

Size H x W	Watts	BTU	Element Output	Element Type	Code	£ Ex VAT	£ Inc VAT
300 x 1148mm	889	3034	450W	A, A+, C, E*, H	81.0021	473.00	567.60
300 x 1373mm	1067	3641	600W	A, A+, C, E*, H	81.0022	569.00	682.80
600 x 428mm	567	1933	300W	A, A+, C, H	81.0046	217.00	260.40
600 x 473mm	630	2148	300W	A, A+, C, H	81.0047	240.00	288.00
600 x 518mm	693	2362	300W	A, A+, C, H	81.0048	259.00	310.80
600 x 563mm	756	2577	450W	A, A+, C, H	81.0049	288.00	345.60
600 x 608mm	818	2792	450W	A, A+, C, H	81.0023	317.00	380.40
600 x 833mm	1133	3866	600W	A, A+, C, E*, H	81.0024	435.00	522.00
600 x 1010mm	1385	4727	750W	A, A+, C, H	81.0090	535.00	642.00
600 x 1148mm	1573	5369	900W	A, A+, H	81.0025	604.00	724.80
600 x 1460mm	2014	6874	1200W	A, A+, H	81.0091	774.00	928.80
1800 x 293mm	933	3185	N/A	N/A	81.0018	284.00	340.80
1800 x 383mm	1245	4247	N/A	N/A	81.0019	370.00	444.00
1800 x 473mm	1556	5308	N/A	N/A	81.0020	466.00	559.20

\*600w Type E Element can be fitted

### Rivassa Two Column Radiators - Matt Black

Size H x W	Watts	BTU	Element Output	Element Type	Code	£ Ex VAT	£ Inc VAT
300 x 1148mm	889	3034	450W	A, A+, C, E*, H	81.0208	473.00	567.60
300 x 1373mm	1067	3641	600W	A, A+, C, E*, H	81.0209	569.00	682.80
600 x 428mm	567	1933	300W	A, A+, C, H	81.0210	217.00	260.40
600 x 473mm	630	2148	300W	A, A+, C, H	81.0211	240.00	288.00
600 x 518mm	693	2362	300W	A, A+, C, H	81.0212	259.00	310.80
600 x 563mm	756	2577	450W	A, A+, C, H	81.0213	288.00	345.60
600 x 608mm	818	2792	450W	A, A+, C, H	81.0214	317.00	380.40
600 x 833mm	1133	3866	600W	A, A+, C, E*, H	81.0215	435.00	522.00
600 x 1010mm	1385	4727	750W	A, A+, C, H	81.0216	535.00	642.00
600 x 1148mm	1573	5369	900W	A, A+, H	81.0217	604.00	724.80
600 x 1460mm	2014	6874	1200W	A, A+, H	81.0218	774.00	928.80
1800 x 293mm	933	3185	N/A	N/A	81.0219	284.00	340.80
1800 x 383mm	1245	4247	N/A	N/A	81.0220	370.00	444.00
1800 x 473mm	1556	5308	N/A	N/A	81.0221	466.00	559.20

\*600w Type E Element can be fitted

### TECHNICAL INFORMATION

All measurements in Height by Width. Heat output based on  $\Delta T60^{\circ}\text{C}$ . Radiators that are electric only are restricted to the heat output of the elements. Element size can be increased to full capacity of rail if using element type C, E or H. For element types see pages 288-300. For matching valves see pages 301-309. For indirect heating systems. Tappings are the width of the rail and 65.5mm off the wall. Prices include radiator and wall fixings sets, valves extra.

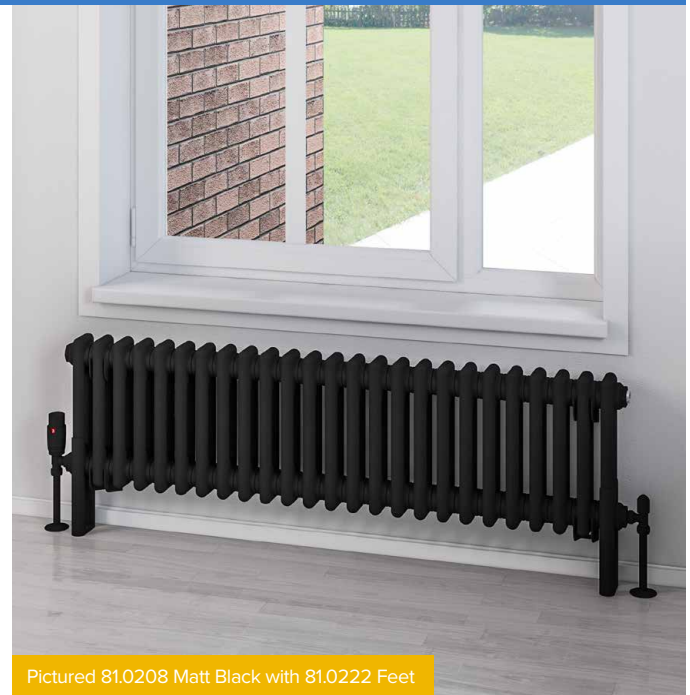

Pictured 81.0208 Matt Black with 81.0222 Feet

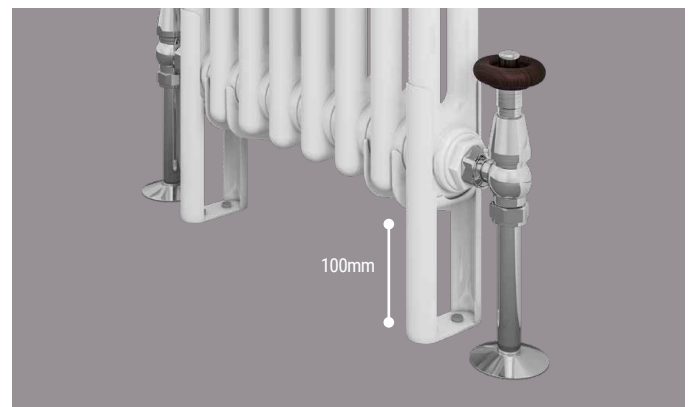

### Rivassa Radiator Feet

Description	Code	£ Ex VAT	£ Inc VAT
Rivassa 2 Column Radiator Feet (pair) White	81.0034	37.00	44.40
Rivassa 2 Column Rad. Feet (pair) Matt Anthracite	81.0035	37.00	44.40
Rivassa 2 Column Rad. Feet (pair) Matt Black	81.0222	37.00	44.40



Pictured 81.0049 Matt Anthracite with 16.158 Towel Hanger

### Rivassa Towel Hangers

Page 310



### Robe Hooks

Page 310

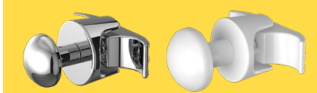

### Round Vent Caps

Page 313



# Traditional Range

## RIVASSA 2 COLUMN

Bronze Effect



Pictured 81.0111 Bronze Effect with 81.0114 feet

Bronze effect colour shown in images are subject to the limitations of the printing process and may appear different.



## Chrome Effect



Pictured 81.0123 Chrome Effect

Chrome effect colour shown in images are subject to the limitations of the printing process and may appear different.

# Traditional Range

## RIVASSA 2 COLUMN

### Rivassa Two Column Radiators - Bronze Effect

Size H x W	Watts	BTU	Element Output	Element Type	Code	£ Ex VAT	£ Inc VAT
600 x 608mm	818	2792	450W	A, A+, C, H	81.0108	315.00	<b>378.00</b>
600 x 833mm	1133	3866	600W	A, A+, C, E*, H	81.0109	436.00	<b>523.20</b>
600 x 1010mm	1385	4727	750W	A, A+, C, H	81.0110	535.00	<b>642.00</b>
600 x 1148mm	1573	5369	900W	A, A+, H	81.0111	604.00	<b>724.80</b>
1800 x 383mm	1245	4247	N/A	N/A	81.0113	375.00	<b>450.00</b>
1800 x 473mm	1556	5308	N/A	N/A	81.0112	466.00	<b>559.20</b>

\*600w Type E Element can be fitted

### Rivassa Two Column Radiators - Chrome Effect

Size H x W	Watts	BTU	Element Output	Element Type	Code	£ Ex VAT	£ Inc VAT
600 x 608mm	818	2792	450W	A, A+, C, H	81.0122	327.00	<b>392.40</b>
600 x 833mm	1133	3866	600W	A, A+, C, E*, H	81.0123	450.00	<b>540.00</b>
600 x 1010mm	1385	4727	750W	A, A+, C, H	81.0124	549.00	<b>658.80</b>
600 x 1148mm	1573	5369	900W	A, A+, H	81.0125	622.00	<b>746.40</b>
1800 x 383mm	1245	4247	N/A	N/A	81.0127	385.00	<b>462.00</b>
1800 x 473mm	1556	5308	N/A	N/A	81.0126	480.00	<b>576.00</b>

\*600w Type E Element can be fitted

A traditional rail which will give a Victorian touch of authenticity to any room but will also create an elegant look to a contemporary interior. This radiator boasts high outputs to ensure the whole room is warm. Comes with the option of traditional legs and in bronze effect or chrome effect finishes. Also available in three columns.

#### FEATURES

- Tested to BS EN 442 standards
- 5 Year Manufacturer's Warranty\*
- Matching colour wall fixing sets
- Radiator feet option available to get the classic look
- Material thickness 1.5mm
- Doesn't require flow diverter
- \* With conditions

Technical Tables & Drawings  
Page 384-385



#### TECHNICAL INFORMATION

All measurements in Height by Width. Heat output based on  $\Delta T60^{\circ}C$ . Radiators that are electric only are restricted to the heat output of the elements. Element size can be increased to full capacity of rail if using element type C, E or H. For element types see pages 288-300. For matching valves see pages 301-309. For indirect heating systems. Tappings are the width of the rail and 65.5mm off the wall. Prices include radiator and wall fixings sets, valves extra.

#### COMPLETE THE LOOK

Traditional TRVs  
Page 304



#### Angle TRV with Lockshield 15mm (pair) - Chrome

Code	£ Ex VAT	£ Inc VAT
54.0008	90.00	<b>108.00</b>



#### Angle TRV with Lockshield 15mm (pair) - Satin Nickel

Code	£ Ex VAT	£ Inc VAT
54.0009	97.00	<b>116.40</b>

#### Bronze Effect



#### Chrome Effect

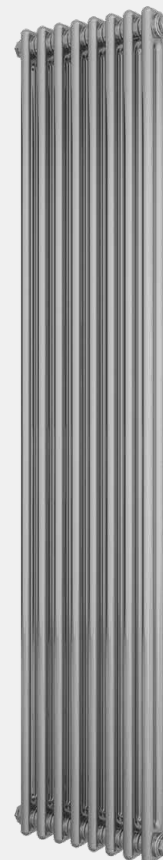

#### Warranty

5  
Year

#### Heating



#### All Electric



#### Dual-Fuel

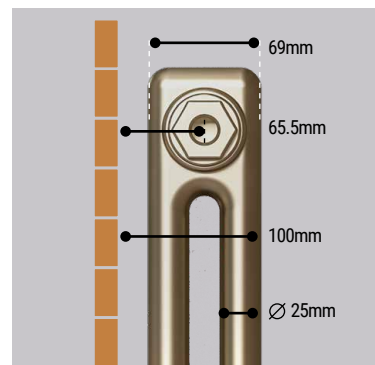

#### RIVASSA 2 COLUMN RADIATOR FEET

#### Rivassa 2 Column Feet - Bronze Effect

Description	Code	£ Ex VAT	£ Inc VAT
2 Column Radiator Feet (pair)	81.0114	37.00	<b>44.40</b>

#### Rivassa 2 Column Feet - Chrome Effect

Description	Code	£ Ex VAT	£ Inc VAT
2 Column Radiator Feet (pair)	81.0128	38.00	<b>45.60</b>

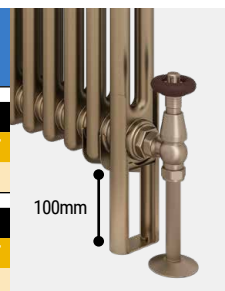

#### Robe Hooks

Page 310

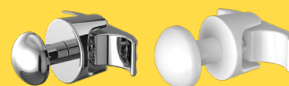

#### Rivassa Towel Hangers

Page 310



# Traditional Range

## RIVASSA 3 COLUMN



Pictured 81.0028 Matt Anthracite

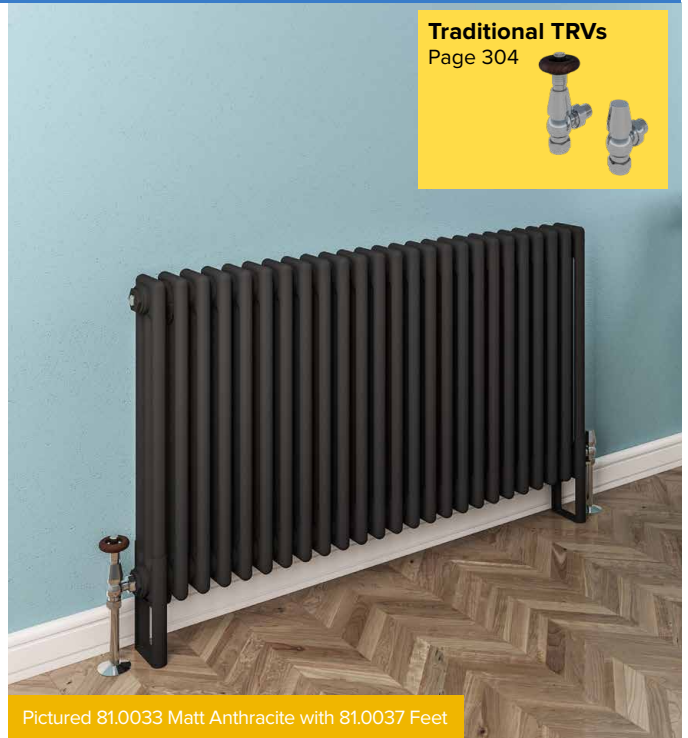

Pictured 81.0033 Matt Anthracite with 81.0037 Feet



Pictured 81.0016 Gloss White

A traditional rail which will give a Victorian touch of authenticity to any room but will also create an elegant look to a contemporary interior. This radiator boasts high outputs to ensure the whole room is warm. Comes with the option of traditional legs and in gloss white, matt anthracite or matt black finishes. Also available in two and four columns.

### FEATURES

- Tested to BS EN 442 standards
- 5 Year Manufacturer's Warranty\*
- Matching colour wall fixing sets
- 300mm height option for limited spaces
- Radiator feet option available to get the classic look
- Material thickness 1.5mm
- Doesn't require flow diverter
- \* With conditions

**Technical Tables & Drawings**  
Page 384-385



Warranty

5  
Year

Heating



All Electric



Dual-Fuel

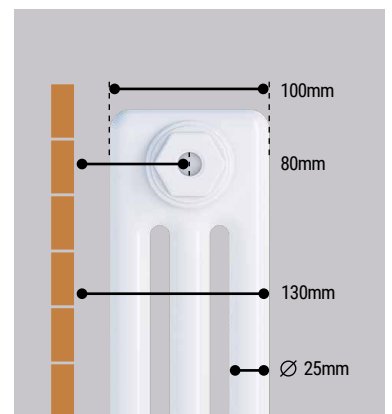



# Traditional Range

## RIVASSA 3 COLUMN

### Rivassa Three Column Radiators - White

Size H x W	Watts	BTU	Element Output	Element Type	Code	£ Ex VAT	£ Inc VAT
300 x 1148mm	1118	3816	600W	A, A+, C, E*, H	81.0013	496.00	595.20
300 x 1373mm	1342	4579	750W	A, A+, C, E*, H	81.0014	593.00	711.60
600 x 428mm	734	2504	450W	A, A+, C, H	81.0042	227.00	272.40
600 x 473mm	816	2782	450W	A, A+, C, H	81.0043	250.00	300.00
600 x 518mm	898	3061	450W	A, A+, C, H	81.0044	275.00	330.00
600 x 563mm	979	3339	600W	A+, C, H	81.0045	299.00	358.80
600 x 608mm	1060	3616	600W	A+, C, H	81.0015	329.00	394.80
600 x 833mm	1467	5007	900W	A+, C, H	81.0016	454.00	544.80
600 x 1010mm	1794	6123	1000W	A, A+, C, H	81.0079	552.00	662.40
600 x 1148mm	2038	6954	1200W	A, A+, H	81.0017	626.00	751.20
600 x 1460mm	2609	8904	1200W	A, A+, H	81.0080	804.00	964.80
1800 x 293mm	1563	5333	N/A	N/A	81.0010	305.00	366.00
1800 x 383mm	2084	7111	N/A	N/A	81.0011	380.00	456.00
1800 x 473mm	2605	8889	N/A	N/A	81.0012	473.00	567.60

\*600w Type E Element can be fitted

### Rivassa Three Column Radiators - Matt Anthracite

Size H x W	Watts	BTU	Element Output	Element Type	Code	£ Ex VAT	£ Inc VAT
300 x 1148mm	1118	3816	600W	A, A+, C, E*, H	81.0029	503.00	603.60
300 x 1373mm	1342	4579	750W	A, A+, C, E*, H	81.0030	604.00	724.80
600 x 428mm	734	2504	450W	A, A+, C, H	81.0050	230.00	276.00
600 x 473mm	816	2782	450W	A, A+, C, H	81.0051	255.00	306.00
600 x 518mm	898	3061	450W	A, A+, C, H	81.0052	283.00	339.60
600 x 563mm	979	3339	600W	A+, C, H	81.0053	304.00	364.80
600 x 608mm	1060	3616	600W	A+, C, H	81.0031	334.00	400.80
600 x 833mm	1467	5007	900W	A+, C, H	81.0032	460.00	552.00
600 x 1010mm	1794	6123	1000W	A, A+, C, H	81.0092	563.00	675.60
600 x 1148mm	2038	6954	1200W	A, A+, H	81.0033	639.00	766.80
600 x 1460mm	2609	8904	1200W	A, A+, H	81.0093	817.00	980.40
1800 x 293mm	1563	5333	N/A	N/A	81.0026	311.00	373.20
1800 x 383mm	2084	7111	N/A	N/A	81.0027	389.00	466.80
1800 x 473mm	2605	8889	N/A	N/A	81.0028	482.00	578.40

\*600w Type E Element can be fitted

### Rivassa Three Column Radiators - Matt Black

Size H x W	Watts	BTU	Element Output	Element Type	Code	£ Ex VAT	£ Inc VAT
300 x 1148mm	1118	3816	600W	A, A+, C, E*, H	81.0223	503.00	603.60
300 x 1373mm	1342	4579	750W	A, A+, C, E*, H	81.0224	604.00	724.80
600 x 428mm	734	2504	450W	A, A+, C, H	81.0225	230.00	276.00
600 x 473mm	816	2782	450W	A, A+, C, H	81.0226	255.00	306.00
600 x 518mm	898	3061	450W	A, A+, C, H	81.0227	283.00	339.60
600 x 563mm	979	3339	600W	A+, C, H	81.0228	304.00	364.80
600 x 608mm	1060	3616	600W	A+, C, H	81.0229	334.00	400.80
600 x 833mm	1467	5007	900W	A+, C, H	81.0230	460.00	552.00
600 x 1010mm	1794	6123	1000W	A, A+, C, H	81.0231	563.00	675.60
600 x 1148mm	2038	6954	1200W	A, A+, H	81.0232	639.00	766.80
600 x 1460mm	2609	8904	1200W	A, A+, H	81.0233	817.00	980.40
1800 x 293mm	1563	5333	N/A	N/A	81.0234	311.00	373.20
1800 x 383mm	2084	7111	N/A	N/A	81.0235	389.00	466.80
1800 x 473mm	2605	8889	N/A	N/A	81.0236	482.00	578.40

\*600w Type E Element can be fitted

### TECHNICAL INFORMATION

All measurements in Height by Width. Heat output based on  $\Delta T60^{\circ}\text{C}$ . Radiators that are electric only are restricted to the heat output of the elements. Element size can be increased to full capacity of rail if using element type C, E or H. For element types see pages 288-300. For matching valves see pages 301-309. For indirect heating systems. Tappings are the width of the rail and 80mm off the wall. Prices include radiator and wall fixings sets, valves extra.



Pictured 81.0231 Matt Black with 81.0237 Feet

### RIVASSA 3 COLUMN RADIATOR FEET

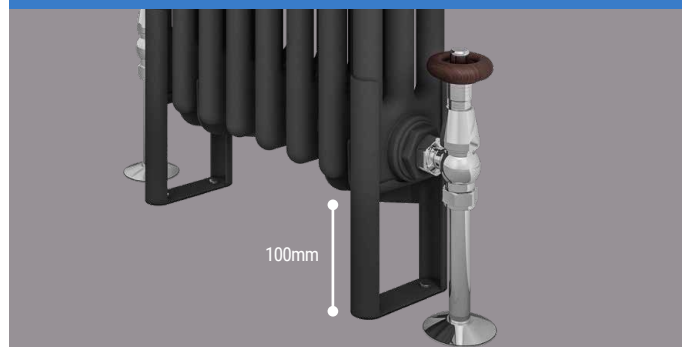

#### Rivassa Radiator Feet

Description	Code	£ Ex VAT	£ Inc VAT
Rivassa 3 Column Radiator Feet (pair) White	81.0036	37.00	44.40
Rivassa 3 Column Radiator Feet (pair) Matt Anthracite	81.0037	37.00	44.40
Rivassa 3 Column Radiator Feet (pair) Matt Black	81.0237	37.00	44.40



Pictured 81.0042 Gloss White

#### Rivassa Towel Hangers

Page 310



#### Robe Hooks

Page 310



#### Round Vent Caps

Page 313



# Traditional Range

## RIVASSA 3 COLUMN

Bronze Effect

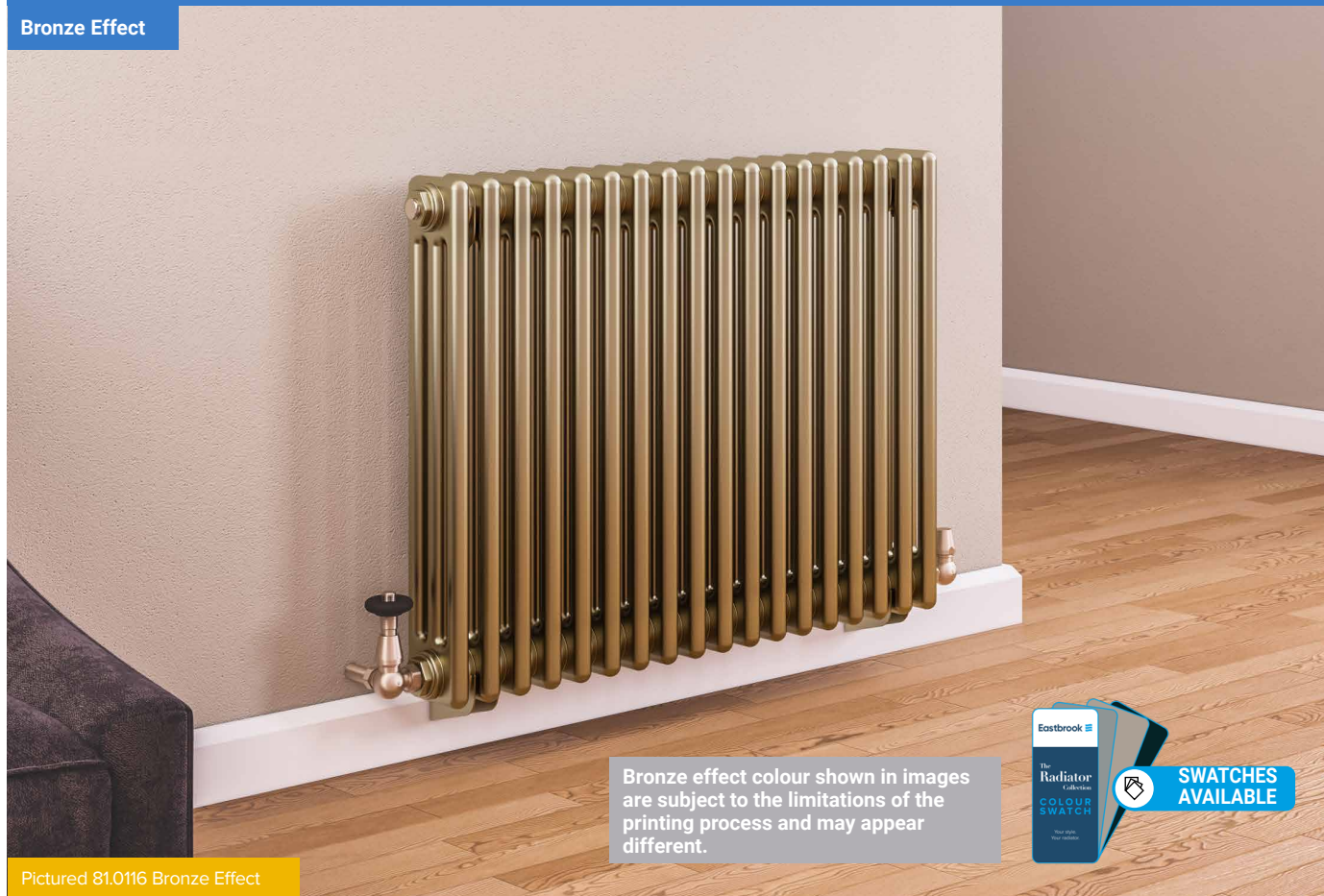

Bronze effect colour shown in images are subject to the limitations of the printing process and may appear different.



Pictured 81.0116 Bronze Effect

## Chrome Effect

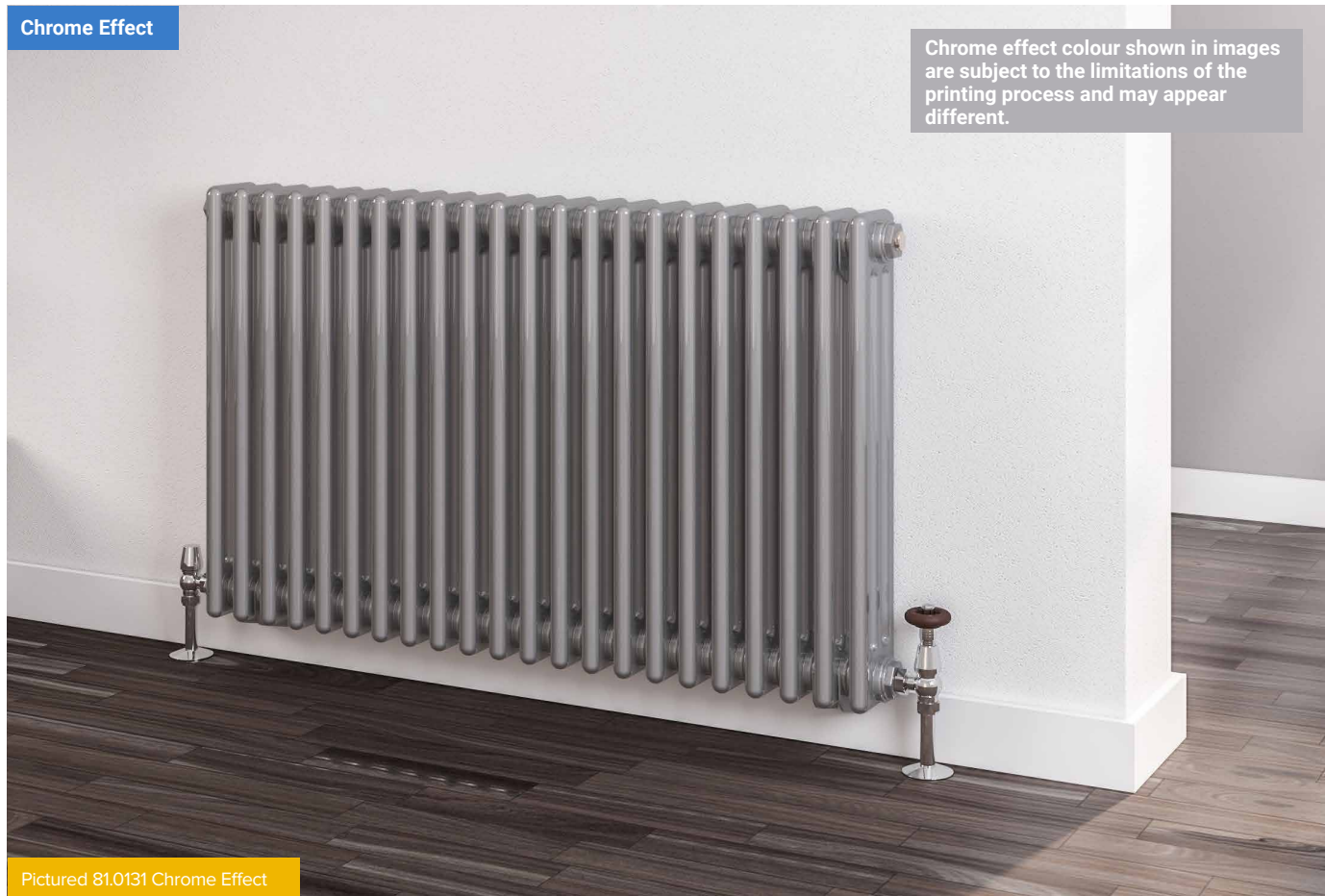

Chrome effect colour shown in images are subject to the limitations of the printing process and may appear different.

Pictured 81.0131 Chrome Effect

# Traditional Range

## RIVASSA 3 COLUMN

### Rivassa Three Column Radiators - Bronze Effect

Size H x W	Watts	BTU	Element Output	Element Type	Code	£ Ex VAT	£ Inc VAT
600 x 608mm	1060	3616	600W	A+, C, H	81.0115	334.00	<b>400.80</b>
600 x 833mm	1467	5007	900W	A+, C, H	81.0116	460.00	<b>552.00</b>
600 x 1010mm	1794	6123	1000W	A, A+, C, H	81.0117	563.00	<b>675.60</b>
600 x 1148mm	2038	6954	1200W	A, A+, H	81.0118	640.00	<b>768.00</b>
1800 x 383mm	2084	7111	N/A	N/A	81.0120	392.00	<b>470.40</b>
1800 x 473mm	2605	8889	N/A	N/A	81.0119	491.00	<b>589.20</b>

### Rivassa Three Column Radiators - Chrome Effect

Size H x W	Watts	BTU	Element Output	Element Type	Code	£ Ex VAT	£ Inc VAT
600 x 608mm	1060	3616	600W	A+, C, H	81.0129	345.00	<b>414.00</b>
600 x 833mm	1467	5007	900W	A+, C, H	81.0130	474.00	<b>568.80</b>
600 x 1010mm	1794	6123	1000W	A, A+, C, H	81.0131	580.00	<b>696.00</b>
600 x 1148mm	2038	6954	1200W	A, A+, H	81.0132	658.00	<b>789.60</b>
1800 x 383mm	2084	7111	N/A	N/A	81.0134	404.00	<b>484.80</b>
1800 x 473mm	2605	8889	N/A	N/A	81.0133	508.00	<b>609.60</b>

A traditional rail which will give a Victorian touch of authenticity to any room but will also create an elegant look to a contemporary interior. This radiator boasts high outputs to ensure the whole room is warm. Comes with the option of traditional legs and in bronze effect or chrome effect finishes. Also available in two columns.

#### FEATURES

- Tested to BS EN 442 standards
  - 5 Year Manufacturer's Warranty\*
  - Matching colour wall fixing sets
  - Radiator feet option available to get the classic look
  - Material thickness 1.5mm
  - Doesn't require flow diverter
- \* With conditions

**Technical Tables & Drawings**  
Page 384-385



#### TECHNICAL INFORMATION

All measurements in Height by Width. Heat output based on  $\Delta T60^{\circ}\text{C}$ . Radiators that are electric only are restricted to the heat output of the elements. Element size can be increased to full capacity of rail if using element type C, E or H. For element types see pages 288-300. For matching valves see pages 301-309. For indirect heating systems. Tappings are the width of the rail and 80mm off the wall. Prices include radiator and wall fixings sets, valves extra.

#### COMPLETE THE LOOK

**Traditional TRVs**  
Page 304



#### Angle TRV with Lockshield 15mm (pair) - Chrome

Code	£ Ex VAT	£ Inc VAT
54.0008	90.00	<b>108.00</b>



#### Angle TRV with Lockshield 15mm (pair) - Satin Nickel

Code	£ Ex VAT	£ Inc VAT
54.0009	97.00	<b>116.40</b>

#### Bronze Effect



#### Chrome Effect



#### Warranty

5  
Year

#### Heating



#### All Electric



#### Dual-Fuel

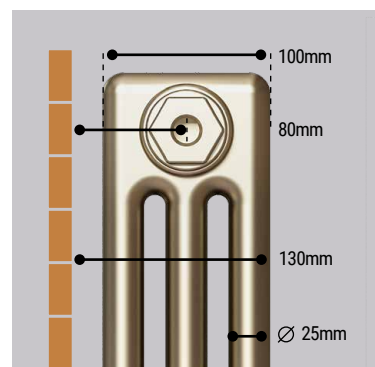

#### RIVASSA 3 COLUMN RADIATOR FEET

#### Rivassa 3 Column Feet - Bronze Effect

Description	Code	£ Ex VAT	£ Inc VAT
3 Column Radiator Feet (pair)	81.0121	37.00	<b>44.40</b>

#### Rivassa 3 Column Feet - Chrome Effect

Description	Code	£ Ex VAT	£ Inc VAT
3 Column Radiator Feet (pair)	81.0135	38.00	<b>45.60</b>

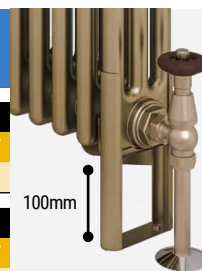

#### Rivassa Towel Hangers

Page 310



#### Robe Hooks

Page 310



# Traditional Range

## RIVASSA 4 COLUMN



**Traditional TRVs**  
Page 304

Pictured 81.0074 Gloss White with 81.0076 Feet



**Rivassa Towel Hangers**  
Page 310

Pictured 81.0088 Matt Anthracite

A traditional rail which will give a Victorian touch of authenticity to any room but will also create an elegant look to a contemporary interior. This radiator boasts high outputs to ensure the whole room is warm. Comes with the option of traditional legs and in gloss white, matt anthracite or matt black finishes. Also available in two and three columns.

**FEATURES**

- Tested to BS EN 442 standards
- 5 Year Manufacturer's Warranty\*
- Matching colour wall fixing sets
- 300mm height option for limited spaces
- Radiator feet option available to get the classic look
- Material thickness 1.5mm
- Doesn't require flow diverter
- \* With conditions

Warranty

**5**

Year

Heating

All Electric

Dual-Fuel

**Technical Tables & Drawings**  
Page 386-387

# Traditional Range

## RIVASSA 4 COLUMN

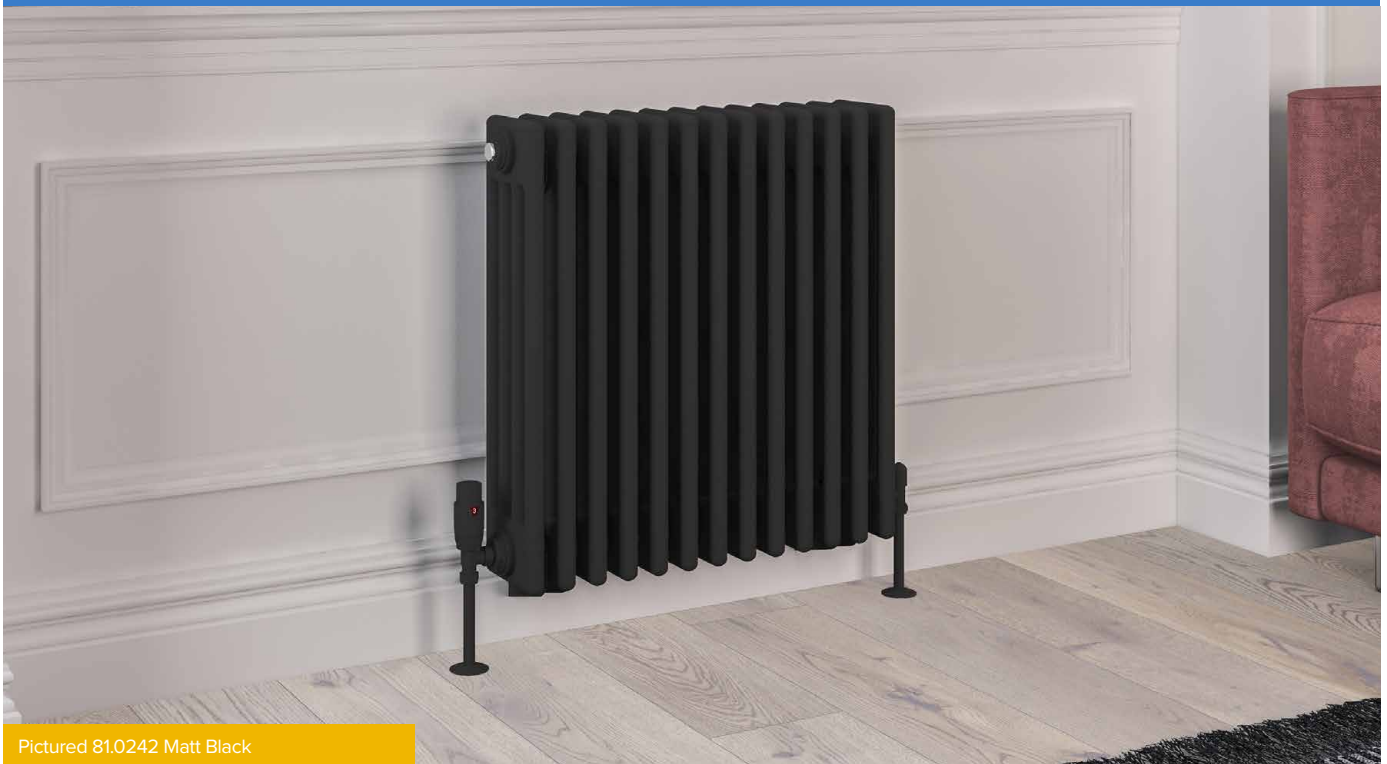

Pictured 81.0242 Matt Black

### Rivassa Four Column Radiators - Gloss White

Size H x W	Watts	BTU	Element Output	Element Type	Code	£ Ex VAT	£ Inc VAT
300 x 1010mm	1197	4085	600W	A, A+, C, E*, H	81.0068	502.00	<b>602.40</b>
300 x 1373mm	1633	5573	1000W	A, A+, H	81.0069	685.00	<b>822.00</b>
300 x 1505mm	1796	6110	1000W	A+, H	81.0070	751.00	<b>901.20</b>
600 x 425mm	869	2966	450W	A, A+	81.0071	301.00	<b>361.20</b>
600 x 605mm	1255	4283	750W	A+, C, H	81.0072	432.00	<b>518.40</b>
600 x 785mm	1641	5601	900W	A+, H	81.0073	563.00	<b>675.60</b>
600 x 1010mm	2124	7249	1200W	A, A+	81.0074	726.00	<b>871.20</b>
600 x 1190mm	2510	8567	1200W	A, A+	81.0075	859.00	<b>1030.80</b>

\*600w Type E Element can be fitted

### Rivassa Four Column Radiators - Matt Black

Size H x W	Watts	BTU	Element Output	Element Type	Code	£ Ex VAT	£ Inc VAT
300 x 1010mm	1197	4085	600W	A, A+, C, E*, H	81.0238	513.00	<b>615.60</b>
300 x 1373mm	1633	5573	1000W	A, A+, H	81.0239	699.00	<b>838.80</b>
300 x 1505mm	1796	6110	1000W	A+, H	81.0240	767.00	<b>920.40</b>
600 x 425mm	869	2966	450W	A, A+	81.0241	305.00	<b>366.00</b>
600 x 605mm	1255	4283	750W	A+, C, H	81.0242	441.00	<b>529.20</b>
600 x 785mm	1641	5601	900W	A+, H	81.0243	574.00	<b>688.80</b>
600 x 1010mm	2124	7249	1200W	A, A+	81.0244	743.00	<b>891.60</b>
600 x 1190mm	2510	8567	1200W	A, A+	81.0245	874.00	<b>1048.80</b>

\*600w Type E Element can be fitted

### Rivassa Four Column Radiators - Matt Anthracite

Size H x W	Watts	BTU	Element Output	Element Type	Code	£ Ex VAT	£ Inc VAT
300 x 1010mm	1197	4085	600W	A, A+, C, E*, H	81.0081	513.00	<b>615.60</b>
300 x 1373mm	1633	5573	1000W	A, A+, H	81.0082	699.00	<b>838.80</b>
300 x 1505mm	1796	6110	1000W	A+, H	81.0083	767.00	<b>920.40</b>
600 x 425mm	869	2966	450W	A, A+	81.0084	305.00	<b>366.00</b>
600 x 605mm	1255	4283	750W	A+, C, H	81.0085	441.00	<b>529.20</b>
600 x 785mm	1641	5601	900W	A+, H	81.0086	574.00	<b>688.80</b>
600 x 1010mm	2124	7249	1200W	A, A+	81.0087	743.00	<b>891.60</b>
600 x 1190mm	2510	8567	1200W	A, A+	81.0088	874.00	<b>1048.80</b>

\*600w Type E Element can be fitted

### TECHNICAL INFORMATION

All measurements in Height by Width. Heat output based on  $\Delta T60^{\circ}\text{C}$ . Radiators that are electric only are restricted to the heat output of the elements. Element size can be increased to full capacity of rail if using element type C, E or H. For element types see pages 288-300. For matching valves see pages 301-309. For indirect heating systems. Tappings are the width of the rail and 95mm off the wall. Projection from wall 165mm. Prices include radiator and wall fixings sets, valves extra.

### RIVASSA 4 COLUMN RADIATOR FEET

Description	Code	£ Ex VAT	£ Inc VAT
Rivassa 4 Column Radiator Feet (pair) - Gloss White	81.0076	45.00	<b>54.00</b>
Rivassa 4 Column Radiator Feet (pair) - Matt Anthracite	81.0089	45.00	<b>54.00</b>
Rivassa 4 Column Radiator Feet (pair) - Matt Black	81.0246	45.00	<b>54.00</b>

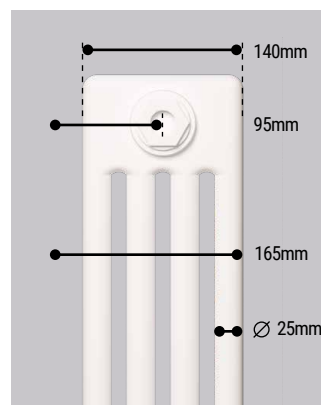

### Round Vent Caps

Page 313



### Robe Hooks

Page 310

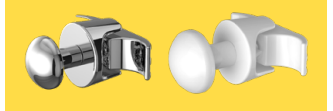

# Traditional Range



## LEADON

For element types see pages 288-300. see pages 828-840.

Our traditional range of radiators offer character and flair to ensure they fit in with your classic designs. These rails should only be used on closed or indirect heating circuits, not on fresh water hot systems as they are of steel construction.

Leadon - Chrome / Gloss White							
Size H x W x D	Watts	BTU	Element Output	Element Type	Code	£ Ex VAT	£ Inc VAT
940 x 700 x 260mm	897	3061	450W	A, A+, C, H	41.1007	649.00	<b>778.80</b>

Tappings are approx. 130mm less than the width of the rail and approx. 137mm off the wall.

### FEATURES

- Tested to BS EN 442 standards
- 5 Year Manufacturer's Warranty\*
- Can be single or dual fuel, or all electric
- \* With conditions

### Technical Tables & Drawings

Page 386-387



### TECHNICAL INFORMATION

All measurements in Height by Width. Heat output based on  $\Delta T60^{\circ}\text{C}$ . Radiators that are electric only are restricted to the heat output of the elements. Element size can be increased to full capacity of rail if using element type C or H. For element types see pages 288-300. For matching valves see pages 301-309. For indirect heating systems. Prices include radiator and wall fixings sets, valves extra.

Warranty

# 5

Year

Heating

All Electric

Dual-Fuel

Pair of Radiator Valves & Tails		
Code	£ Ex VAT	£ Inc VAT
54.0001	54.00	<b>64.80</b>

Radiator valves sold separately



## THAMES

For element types see pages 288-300.

Our traditional range of radiators offer character and flair to ensure they fit in with your classic designs. These rails only be used on closed or indirect heating circuits, not on fresh water hot systems as they are of steel construction.

Thames - Chrome / Gloss White							
Size H x W x D	Watts	BTU	Element Output	Element Type	Code	£ Ex VAT	£ Inc VAT
1444 x 630 x 187mm	945	3224	450W	A, A+, C, H	41.1004	725.00	<b>870.00</b>

Tappings are approx. 130mm less than the width of the rail and approx. 150mm off the wall.

### FEATURES

- Tested to BS EN 442 standards
- 5 Year Manufacturer's Warranty\*
- Can be single or dual fuel, or all electric
- \* With conditions

### Technical Tables & Drawings

Page 386-387



### TECHNICAL INFORMATION

All measurements in Height by Width. Heat output based on  $\Delta T60^{\circ}\text{C}$ . Radiators that are electric only are restricted to the heat output of the elements. Element size can be increased to full capacity of rail if using element type C or H. For element types see pages 288-300. For matching valves see pages 301-309. For indirect heating systems. Prices include radiator and wall fixings sets, valves extra.

Warranty

# 5

Year

Heating

All Electric

Dual-Fuel

Pair of Radiator Valves & Tails		
Code	£ Ex VAT	£ Inc VAT
54.0001	54.00	<b>64.80</b>

Radiator valves sold separately

# Traditional Range



For element types see pages 288-300. see pages 828-840.

Our traditional range of radiators offer character and flair to ensure they fit in with your classic designs. These rails should only be used on closed or indirect heating circuits, not on fresh water hot systems as they are of steel construction.

Coln - Chrome / Gloss White							
Size H x W x D	Watts	BTU	Element Output	Element Type	Code	£ Ex VAT	£ Inc VAT
510 x 680 x 260mm	704	2402	300W	A, A+, C, H	41.1002	491.00	<b>589.20</b>

On dual fuel installation, please use only Type A element. Tappings approx. 4mm less than the width of the rail and approx. 50mm off the wall.

- FEATURES**
- Tested to BS EN 442 standards
  - 5 Year Manufacturer's Warranty\*
  - Can be single or dual fuel, or all electric
  - \* With conditions

**Technical Tables & Drawings**  
Page 386-387

**TECHNICAL INFORMATION**

All measurements in Height by Width. Heat output based on  $\Delta T60^{\circ}C$ . Radiators that are electric only are restricted to the heat output of the elements. Element size can be increased to full capacity of rail if using element type C or H. For element types see pages 288-300. For matching valves see pages 301-309. For indirect heating systems. Prices include radiator and wall fixings sets, valves extra.

Warranty

**5**

Year

Heating

All Electric

Dual-Fuel

Pair of Radiator Valves & Tails		
Code	£ Ex VAT	£ Inc VAT
54.0001	54.00	<b>64.80</b>

Radiator valves sold separately



Our traditional range of radiators offer character and flair to ensure they fit in with your classic designs. These rails should only be used on closed or indirect heating circuits, not on fresh water hot systems as they are of steel construction.

Twyver - Chrome / Gloss White							
Size H x W x D	Watts	BTU	Element Output	Element Type	Code	£ Ex VAT	£ Inc VAT
952 x 684 x 158mm	580	1979	N/A	N/A	41.1011	669.00	<b>802.80</b>

Tappings are approx. 137mm less than the width of the rail and approx. 108mm off the wall.

- FEATURES**
- Tested to BS EN 442 standards.
  - 5 Year Manufacturer's Warranty\*
  - Not suitable for elements
  - \* With conditions

**Technical Tables & Drawings**  
Page 386-387

**TECHNICAL INFORMATION**

All measurements in Height by Width. Heat output based on  $\Delta T60^{\circ}C$ . For matching valves see pages 301-309. For indirect heating systems. Prices include radiator and wall fixings sets, valves extra.

Warranty

**5**

Year

Heating

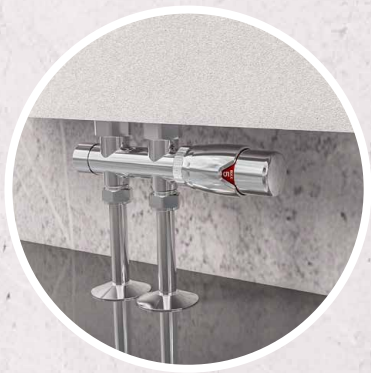



# Accessories, Elements & Valves

A huge variety of elements and valves to allow easy control of your radiators heat output, whilst looking stylish.

Complete the look with coloured pipe shrouds and vent caps to match your radiator colour.

To add extra functionality, towel hangers & robe hooks make daily life easy when warming towels.

## Contents

Elements - <b>NEW PRODUCT</b>	288-300
Crafton Control Plate, T Pieces, Elbows & Corner Dual Fuel TRV's - <b>NEW COLOUR</b>	301
Valves, Contemporary & Traditional - <b>NEW PRODUCT</b>	301-309
Twin Thermostatic Valves	304
Manual Radiator Valves - <b>NEW COLOUR</b>	305-307
Thermostatic Radiator Valves - <b>NEW COLOUR</b>	303-304 308-309
Multi-Rail Towel Hangers, Towel Hangers & Robe Hooks	310
Pipe Shrouds & Collar Kits - <b>NEW PRODUCT</b>	311
Multi Purpose Towel Hangers	312
Vent Caps, Round & D Shape	313



# Elements

## Build up your 'All Electric' Towel Rail/Radiator

Please note that all fluid filled rails are special order, elements will be fitted RH Side and are non-returnable.

### Step 1

Choose your towel rail/radiator (Please make sure that you can see the "All Electric / Dual Fuel" icon on the chosen towel rail/radiator page).

### Step 2

Refer to the "Element Output" column for the required output to suit the chosen towel rail/radiator.

### Step 3

Choose which element type best suits your need from the "Element Type" column. Please check that the IP Rating is suitable for the site circumstances.

### Step 4

For "All Electric" installation please add Fluid Filling.

## Build up your 'Dual Fuel' Towel Rail/Radiator

Repeat Steps 1-3 as left. Please add your radiator valves and dual elbow where applicable.

Fluid filling is not required.

### ELEMENT TYPE A+ ECO

Due in November 2023

NEW



Vertical & horizontal installation

Power	Length (mm)
100W	135
150W	170
300W	250
450W	350
600W	470
750W	590
900W	690
1000W	760
1200W	910

\*(Not including appropriate element). I.P. rating 55. (Zone 2 and 3)  
Please note all fluid filled rails are special order and are non-returnable.

#### FEATURES

- Elements use PTC self regulating technology providing excellent reliability and extended working life

**TECHNICAL INFORMATION** For an all electric towel rail/radiator, fluid filling must be purchased. Electric only elements will be fitted RH side unless otherwise specified. Cable colour white & length 1.5 metre. For dual fuel installations, purchase T piece separately. (Page 301)  
**Element should be rated at less than 60% of the radiator's output.**

### ELEMENT TYPE A+



Vertical & horizontal installation

Power	Length (mm)
100W	135
150W	170
300W	250
450W	350
600W	470
750W	590
900W	690
1000W	760
1200W	910

\*(Not including appropriate element). I.P. rating 55. (Zone 2 and 3)  
Please note all fluid filled rails are special order and are non-returnable.

#### FEATURES

- Elements use PTC self regulating technology providing excellent reliability and extended working life

**TECHNICAL INFORMATION** For an all electric towel rail/radiator, fluid filling must be purchased. Electric only elements will be fitted RH side unless otherwise specified. Cable colour white & length 1 metre. For dual fuel installations, purchase T piece separately. (Page 301)  
**Element should be rated at less than 60% of the radiator's output.**

Element Type A+ Eco		Item A Required	
Description	Code	£ Ex VAT	£ Inc VAT
100W Type A+ Eco Element	41.0581	51.00	61.20
150W Type A+ Eco Element	41.0582	51.00	61.20
300W Type A+ Eco Element	41.0583	51.00	61.20
450W Type A+ Eco Element	41.0584	53.00	63.60
600W Type A+ Eco Element	41.0585	53.00	63.60
750W Type A+ Eco Element	41.0586	54.00	64.80
900W Type A+ Eco Element	41.0587	54.00	64.80
1000W Type A+ Eco Element	41.0588	54.00	64.80
1200W Type A+ Eco Element	41.0589	54.00	64.80
Fluid filling for above rail (electric only)*	FF	123.00	147.60

\*All Type A+ Eco must be fitted with cover cap. (Below)

Element Type A+ Eco Cover Caps		Item B Required	
Description	Code	£ Ex VAT	£ Inc VAT
Gloss White Cover Cap	41.0590	6.00	7.20
Black Cover Cap	41.0591	6.00	7.20
Chrome Cover Cap	41.0592	9.00	10.80
Grey Cover Cap	41.0593	9.00	10.80
Anthracite Cover Cap	41.0594	9.00	10.80
Cappuccino Cover Cap	41.0595	9.00	10.80
Brushed Brass Cover Cap	41.0596	12.00	14.40

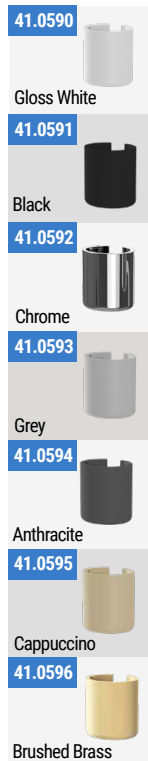

Element Type A+ <th colspan="2">Item A Required</th>		Item A Required	
Description	Code	£ Ex VAT	£ Inc VAT
100 watt element	8.016	65.00	78.00
150 watt element	8.017	65.00	78.00
300 watt element	8.018	68.00	81.60
450 watt element	8.019	73.00	87.60
600 watt element	8.020	95.00	114.00
750 watt element	8.021	98.00	117.60
900 watt element	8.022	102.00	122.40
1000 watt element	8.023	107.00	128.40
1200 watt element	8.024	110.00	132.00
Fluid filling for above rail (electric only)*	FF	123.00	147.60

\*All Type A+ must be fitted with cover cap. (See below)

Element Type A+ Cover Caps		Item B Required	
Description	Code	£ Ex VAT	£ Inc VAT
White Cap	8.025	8.00	9.60
Chrome Cap	8.026	12.00	14.40
Grey Cap	8.027	12.00	14.40
Cappuccino Cap	8.028	12.00	14.40
Anthracite Cap	8.029	12.00	14.40
Black Cap	8.030	12.00	14.40



# Elements

### ELEMENT TYPE A

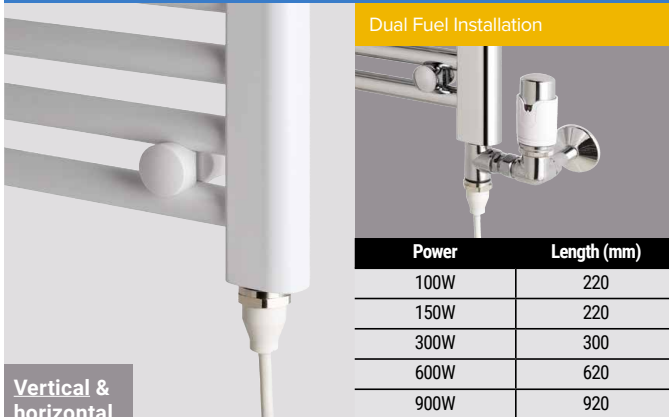

Dual Fuel Installation

Power	Length (mm)
100W	220
150W	220
300W	300
600W	620
900W	920

Vertical & horizontal installation

Element should be rated at less than 60% of the radiator's output.

Element Type A			
Description	Code	£ Ex VAT	£ Inc VAT
100 watt element	8.009	67.00	80.40
150 watt element	8.004	67.00	80.40
300 watt element	8.001	70.00	84.00
600 watt element	8.002	98.00	117.60
900 watt element	8.003	121.00	145.20
Fluid filling for above rail (electric only)*	FF	123.00	147.60

\*(Not including appropriate element). I.P. rating 55. (Zone 2 and 3)  
Please note all fluid filled rails are special order and are **non-returnable**.

#### FEATURES

- Elements use PTC self regulating technology providing excellent reliability and extended working life

**TECHNICAL INFORMATION** For an all electric towel rail/radiator, fluid filling must be purchased. Electric only elements will be fitted RH side unless otherwise specified. Cable colour white & length 1.5 metre. For dual fuel installations, purchase T piece separately. (Page 301)

### ELEMENT TYPE C WATER TEMPERATURE CONTROL



Including radiator temperature thermostat for horizontal installation and supplied with Chrome T piece

Power	Length (mm)
300W	340
600W	390
900W	440

Element Type C			
Description	Code	£ Ex VAT	£ Inc VAT
Up to 300W element (inc rad stat) horizontal	8.300	187.00	224.40
300W to 600W element (inc rad stat) horizontal	8.301	197.00	236.40
600W to 900W element (inc rad stat) horizontal	8.302	202.00	242.40
Fluid filling for above rail (electric only)*	FF	123.00	147.60
Extension piece for type c element**	8.903	20.00	24.00

\*(not including appropriate element). I.P. rating 54. (Zone 2 and 3).  
Please note all fluid filled rails are special order and are **non-returnable**.  
\*\*Some traditional rails may require an extension piece for a type C element.

#### FEATURES

- Water temperature controlled
- Low running costs
- Thermostat
- Simple installation
- Towel drying
- Wide temperature range 10-60°C

**TECHNICAL INFORMATION** For an all electric towel rail/radiator, fluid filling must be purchased. Electric only elements will be fitted RH side unless otherwise specified. Cable colour white & length 1.2 metre. **Only suitable with Chrome T-Piece - 8.901 & Chrome Elbow - 41.3003.**



Corinium Round Towel Rail with Type F Element



Rion Multirail with Type G Element



Rivassa Column Radiator with Type H Element

# Elements

**ELEMENT TYPE D WATER TEMPERATURE CONTROL**



Including radiator temperature thermostat for vertical installation and Chrome T piece

Power	Length
300W	340
600W	390
900W	440

**ELEMENT TYPE D WITH BOOST WATER TEMPERATURE CONTROL**



Turbo Boost Function

Including radiator temperature thermostat for vertical installation and T-Piece\*

\*Chrome, Matt Anthracite & Matt Black elements come with Chrome T-Piece.  
\*Gloss White & Matt White elements both come with white T-Piece.

Power	Length
300W	340
600W	390
900W	440

Chrome

Gloss White

Matt White

Matt Anthracite

Matt Black

**ELEMENT TYPE E WATER TEMPERATURE CONTROL**



Including radiator temperature thermostat for vertical & horizontal installation

Power	Length (mm)
150W	370
300W	390
600W	750

**Element Type D**

Description	Code	£ Ex VAT	£ Inc VAT
Up to 300W element (inc rad stat) vertical	8.310	157.00	<b>188.40</b>
Up to 600W element (inc rad stat) vertical	8.311	165.00	<b>198.00</b>
Up to 900W element (inc rad stat) vertical	8.312	168.00	<b>201.60</b>
Fluid filling for above rail (electric only)*	FF	123.00	<b>147.60</b>

\*(not including appropriate element). I.P. rating 54. (Zone 2 and 3)  
Please note all fluid filled rails are special order and are **non-returnable**.

- FEATURES**
- Off season heating
  - Water temperature controlled Thermostat
  - Low running costs
  - Simple installation
  - Wide temperature range 10-60°C

**TECHNICAL INFORMATION** For an all electric towel rail/radiator, fluid filling must be purchased. Electric only elements will be fitted RH side unless otherwise specified. Cable colour white & length 0.9 metre. **Only suitable with Chrome T-Piece - 8.901 & Chrome Elbow - 41.3003.**

**Element Type D With Boost**

Description	Colour	Code	£ Ex VAT	£ Inc VAT
300W Type D Element with Boost	Chrome	8.320	161.00	<b>193.20</b>
600W Type D Element with Boost	Chrome	8.321	168.00	<b>201.60</b>
900W Type D Element with Boost	Chrome	8.322	174.00	<b>208.80</b>
300W Type D Element with Boost	Gloss White	8.323	161.00	<b>193.20</b>
600W Type D Element with Boost	Gloss White	8.324	168.00	<b>201.60</b>
900W Type D Element with Boost	Gloss White	8.325	174.00	<b>208.80</b>
300W Type D Element with Boost	Matt White	8.326	179.00	<b>214.80</b>
600W Type D Element with Boost	Matt White	8.327	187.00	<b>224.40</b>
900W Type D Element with Boost	Matt White	8.328	192.00	<b>230.40</b>
300W Type D Element with Boost	Matt Anthracite	8.329	179.00	<b>214.80</b>
600W Type D Element with Boost	Matt Anthracite	8.330	187.00	<b>224.40</b>
900W Type D Element with Boost	Matt Anthracite	8.331	192.00	<b>230.40</b>
300W Type D Element with Boost	Matt Black	8.332	179.00	<b>214.80</b>
600W Type D Element with Boost	Matt Black	8.333	187.00	<b>224.40</b>
900W Type D Element with Boost	Matt Black	8.334	192.00	<b>230.40</b>
Fluid filling for above rail (electric only)*	-	FF	123.00	<b>147.60</b>

\*(not including appropriate element). I.P. rating 54. (Zone 2 and 3)  
Please note all fluid filled rails are special order and are **non-returnable**.

- FEATURES**
- Turbo boost function (full heating - 1, 2 or 3 hours settings)
  - Anti-Freeze function
  - Water temperature controlled Thermostat
  - Smooth temperature adjustment (10°C to 65°C)
  - Low running costs
  - Simple installation

**TECHNICAL INFORMATION** For an all electric towel rail/radiator, fluid filling must be purchased. Electric only elements will be fitted RH side unless otherwise specified. Cable colour white & length 0.9 metre. **Only suitable with Chrome T-Piece - 8.901 & Chrome Elbow - 41.3003.**

**Element Type E**

Description	Code	£ Ex VAT	£ Inc VAT
150w Type E Element White	8.034	151.00	<b>181.20</b>
300w Type E Element White	8.035	156.00	<b>187.20</b>
600w Type E Element White	8.036	165.00	<b>198.00</b>
150w Type E Element Chrome	8.031	161.00	<b>193.20</b>
300w Type E Element Chrome	8.032	168.00	<b>201.60</b>
600w Type E Element Chrome	8.033	188.00	<b>225.60</b>
Fluid filling for above rail (electric only)*	FF	123.00	<b>147.60</b>

\*(Not including appropriate element). I.P. rating X4. (Zone 2 and 3)  
Please note all fluid filled rails are special order and are **non-returnable**.

- FEATURES**
- Off season heating
  - Water temperature controlled Thermostat
  - Low running costs
  - Simple installation
  - Wide temperature range 10-60°C
  - For vertical and horizontal installation

**TECHNICAL INFORMATION** For an all electric towel rail/radiator, fluid filling must be purchased. Electric only elements will be fitted RH side unless otherwise specified. **Only suitable with Chrome T-Piece - 8.901 & Chrome Elbow - 41.3003.**

# Elements

Element Type F With D Shape Cap - Chrome				
Description	Colour	Code	£ Ex VAT	£ Inc VAT
150W Type F Element with D Shape Cap	Chrome	8.335	201.00	<b>241.20</b>
300W Type F Element with D Shape Cap	Chrome	8.315	206.00	<b>247.20</b>
600W Type F Element with D Shape Cap	Chrome	8.316	216.00	<b>259.20</b>
900W Type F Element with D Shape Cap	Chrome	8.336	222.00	<b>266.40</b>
1200W Type F Element with D Shape Cap	Chrome	8.337	226.00	<b>271.20</b>
Spare Remote Controller for Type F Element		8.319	67.00	<b>80.40</b>
Fluid filling for above rail (electric only)*	-	FF	123.00	<b>147.60</b>

\*(not including appropriate element). I.P. rating 54. (Zone 2 and 3)  
Please note all fluid filled rails are special order and are **non-returnable**.

### FEATURES

- Comes with remote control, that acts as ambient temperature sensor.
- Turbo boost function (1-3 hours)
- Off season heating
- Cable connection cover included
- Daily & weekly programmable (only on Ambient Mode available)
- Low running costs, towel drying
- Smooth temperature adjustment (10°C to 65°C)
- Thermostat can control either water temperature or ambient room temperature
- Open window detection
- Eco Design ready
- Anti-Freeze function

### TECHNICAL INFORMATION

For an all electric towel rail/radiator, fluid filling must be purchased. Electric only elements will be fitted RH side unless otherwise specified. Cable colour white & length 1.2 metre. **Suitable for electric only installation.**

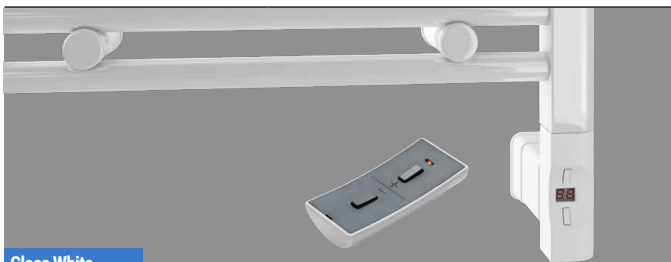

Gloss White

### Element Type F With D Shape Cap - Gloss White

Description	Colour	Code	£ Ex VAT	£ Inc VAT
150W Type F Element with D Shape Cap	Gloss White	8.338	185.00	<b>222.00</b>
300W Type F Element with D Shape Cap	Gloss White	8.313	191.00	<b>229.20</b>
600W Type F Element with D Shape Cap	Gloss White	8.314	201.00	<b>241.20</b>
900W Type F Element with D Shape Cap	Gloss White	8.339	206.00	<b>247.20</b>
1200W Type F Element with D Shape Cap	Gloss White	8.340	212.00	<b>254.40</b>
Spare Remote Controller for Type F Element		8.319	67.00	<b>80.40</b>
Fluid filling for above rail (electric only)*	-	FF	123.00	<b>147.60</b>

\*(not including appropriate element). I.P. rating 54. (Zone 2 and 3)  
Please note all fluid filled rails are special order and are **non-returnable**.



Matt Anthracite

### Element Type F With D Shape Cap - Matt Anthracite

Description	Colour	Code	£ Ex VAT	£ Inc VAT
150W Type F Element with D Shape Cap	Matt Anthracite	8.346	212.00	<b>254.40</b>
300W Type F Element with D Shape Cap	Matt Anthracite	8.317	216.00	<b>259.20</b>
600W Type F Element with D Shape Cap	Matt Anthracite	8.318	226.00	<b>271.20</b>
900W Type F Element with D Shape Cap	Matt Anthracite	8.347	230.00	<b>276.00</b>
1200W Type F Element with D Shape Cap	Matt Anthracite	8.348	236.00	<b>283.20</b>
Spare Remote Controller for Type F Element		8.319	67.00	<b>80.40</b>
Fluid filling for above rail (electric only)*	-	FF	123.00	<b>147.60</b>

\*(not including appropriate element). I.P. rating 54. (Zone 2 and 3)  
Please note all fluid filled rails are special order and are **non-returnable**.

## ELEMENT TYPE F D SHAPE CAP



WATER OR ROOM TEMPERATURE CONTROL

Suitable for electric installation only

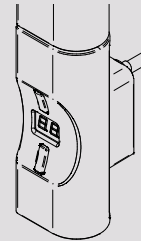

Includes remote control.



### Chrome

Power	Length (mm)
150W	300
300W	340
600W	390
900W	440
1200W	470

Turbo Boost Function

For vertical installation only. Digital temp control element including remote control.

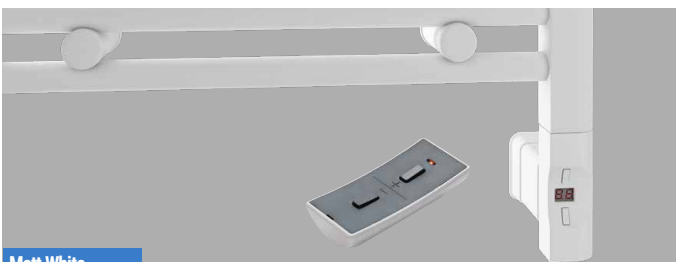

Matt White

### Element Type F With D Shape Cap - Matt White

Description	Colour	Code	£ Ex VAT	£ Inc VAT
150W Type F Element with D Shape Cap	Matt White	8.341	212.00	<b>254.40</b>
300W Type F Element with D Shape Cap	Matt White	8.342	216.00	<b>259.20</b>
600W Type F Element with D Shape Cap	Matt White	8.343	226.00	<b>271.20</b>
900W Type F Element with D Shape Cap	Matt White	8.344	230.00	<b>276.00</b>
1200W Type F Element with D Shape Cap	Matt White	8.345	236.00	<b>283.20</b>
Spare Remote Controller for Type F Element		8.319	67.00	<b>80.40</b>
Fluid filling for above rail (electric only)*	-	FF	123.00	<b>147.60</b>

\*(not including appropriate element). I.P. rating 54. (Zone 2 and 3)  
Please note all fluid filled rails are special order and are **non-returnable**.



Matt Black

### Element Type F With D Shape Cap - Matt Black

Description	Colour	Code	£ Ex VAT	£ Inc VAT
150W Type F Element with D Shape Cap	Matt Black	8.349	212.00	<b>254.40</b>
300W Type F Element with D Shape Cap	Matt Black	8.350	216.00	<b>259.20</b>
600W Type F Element with D Shape Cap	Matt Black	8.351	226.00	<b>271.20</b>
900W Type F Element with D Shape Cap	Matt Black	8.352	230.00	<b>276.00</b>
1200W Type F Element with D Shape Cap	Matt Black	8.353	236.00	<b>283.20</b>
Spare Remote Controller for Type F Element		8.319	67.00	<b>80.40</b>
Fluid filling for above rail (electric only)*	-	FF	123.00	<b>147.60</b>

\*(not including appropriate element). I.P. rating 54. (Zone 2 and 3)  
Please note all fluid filled rails are special order and are **non-returnable**.

# Elements

**WATER OR ROOM TEMPERATURE CONTROL**



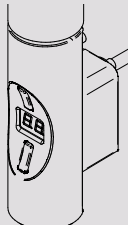

**ELEMENT TYPE F ROUND CAP**

Suitable for electric installation only



Includes remote control.





**Chrome**

Power	Length (mm)
150W	300
300W	340
600W	390
900W	440
1200W	470

**Turbo Boost Function**

**For vertical installation only. Digital temp control element including remote control.**



**Gloss White**

**Element Type F With Round Cap - Gloss White**

Description	Colour	Code	£ Ex VAT	£ Inc VAT
150W Type F Element with Round Cap	Gloss White	8.359	185.00	222.00
300W Type F Element with Round Cap	Gloss White	8.360	191.00	229.20
600W Type F Element with Round Cap	Gloss White	8.361	201.00	241.20
900W Type F Element with Round Cap	Gloss White	8.362	206.00	247.20
1200W Type F Element with Round Cap	Gloss White	8.363	212.00	254.40
Spare Remote Controller for Type F Element		8.319	67.00	80.40
Fluid filling for above rail (electric only)*	-	FF	123.00	147.60

\*(not including appropriate element). I.P. rating 54. (Zone 2 and 3)  
Please note all fluid filled rails are special order and are **non-returnable**.



**Matt Anthracite**

**Element Type F With Round Cap - Matt Anthracite**

Description	Colour	Code	£ Ex VAT	£ Inc VAT
150W Type F Element with Round Cap	Matt Anthracite	8.369	212.00	254.40
300W Type F Element with Round Cap	Matt Anthracite	8.370	216.00	259.20
600W Type F Element with Round Cap	Matt Anthracite	8.371	226.00	271.20
900W Type F Element with Round Cap	Matt Anthracite	8.372	230.00	276.00
1200W Type F Element with Round Cap	Matt Anthracite	8.373	236.00	283.20
Spare Remote Controller for Type F Element		8.319	67.00	80.40
Fluid filling for above rail (electric only)*	-	FF	123.00	147.60

\*(not including appropriate element). I.P. rating 54. (Zone 2 and 3)  
Please note all fluid filled rails are special order and are **non-returnable**.

**Element Type F With Round Cap - Chrome**

Description	Colour	Code	£ Ex VAT	£ Inc VAT
150W Type F Element with Round Cap	Chrome	8.354	201.00	241.20
300W Type F Element with Round Cap	Chrome	8.355	206.00	247.20
600W Type F Element with Round Cap	Chrome	8.356	216.00	259.20
900W Type F Element with Round Cap	Chrome	8.357	222.00	266.40
1200W Type F Element with Round Cap	Chrome	8.358	226.00	271.20
Spare Remote Controller for Type F Element		8.319	67.00	80.40
Fluid filling for above rail (electric only)*	-	FF	123.00	147.60

\*(not including appropriate element). I.P. rating 54. (Zone 2 and 3)  
Please note all fluid filled rails are special order and are **non-returnable**.

- FEATURES**
- Comes with remote control, that acts as ambient temperature sensor.
  - Turbo boost function (1-3 hours)
  - Off season heating
  - Cable connection cover included
  - Daily & weekly programmable (only on Ambient Mode available)
  - Low running costs, towel drying
  - Smooth temperature adjustment (10°C to 65°C)
  - Thermostat can control either water temperature or ambient room temperature
  - Open window detection
  - Eco Design ready
  - Anti-Freeze function

**TECHNICAL INFORMATION**

For an all electric towel rail/radiator, fluid filling must be purchased. Electric only elements will be fitted RH side unless otherwise specified. Cable colour white & length 1.2 metre. **Suitable for electric only installation.**

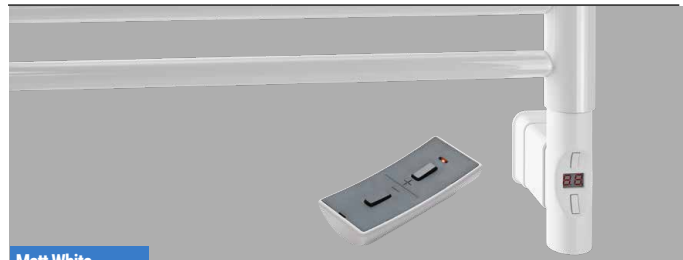

**Matt White**

**Element Type F With Round Cap - Matt White**

Description	Colour	Code	£ Ex VAT	£ Inc VAT
150W Type F Element with Round Cap	Matt White	8.364	212.00	254.40
300W Type F Element with Round Cap	Matt White	8.365	216.00	259.20
600W Type F Element with Round Cap	Matt White	8.366	226.00	271.20
900W Type F Element with Round Cap	Matt White	8.367	230.00	276.00
1200W Type F Element with Round Cap	Matt White	8.368	236.00	283.20
Spare Remote Controller for Type F Element		8.319	67.00	80.40
Fluid filling for above rail (electric only)*	-	FF	123.00	147.60

\*(not including appropriate element). I.P. rating 54. (Zone 2 and 3)  
Please note all fluid filled rails are special order and are **non-returnable**.



**Matt Black**

**Element Type F With Round Cap - Matt Black**

Description	Colour	Code	£ Ex VAT	£ Inc VAT
150W Type F Element with Round Cap	Matt Black	8.374	212.00	254.40
300W Type F Element with Round Cap	Matt Black	8.375	216.00	259.20
600W Type F Element with Round Cap	Matt Black	8.376	226.00	271.20
900W Type F Element with Round Cap	Matt Black	8.377	230.00	276.00
1200W Type F Element with Round Cap	Matt Black	8.378	236.00	283.20
Spare Remote Controller for Type F Element		8.319	67.00	80.40
Fluid filling for above rail (electric only)*	-	FF	123.00	147.60

\*(not including appropriate element). I.P. rating 54. (Zone 2 and 3)  
Please note all fluid filled rails are special order and are **non-returnable**.

# Elements

## Element Type F With Square Cap - Chrome

Description	Colour	Code	£ Ex VAT	£ Inc VAT
150W Type F Element with Square Cap	Chrome	8.379	201.00	<b>241.20</b>
300W Type F Element with Square Cap	Chrome	8.380	206.00	<b>247.20</b>
600W Type F Element with Square Cap	Chrome	8.381	216.00	<b>259.20</b>
900W Type F Element with Square Cap	Chrome	8.382	222.00	<b>266.40</b>
1200W Type F Element with Square Cap	Chrome	8.383	226.00	<b>271.20</b>
Spare Remote Controller for Type F Element		8.319	67.00	<b>80.40</b>
Fluid filling for above rail (electric only)*	-	FF	123.00	<b>147.60</b>

\*(not including appropriate element). I.P. rating 54. (Zone 2 and 3)  
Please note all fluid filled rails are special order and are **non-returnable**.

### FEATURES

- Comes with remote control, that acts as ambient temperature sensor.
- Turbo boost function (1-3 hours)
- Off season heating
- Cable connection cover included
- Daily & weekly programmable (only on Ambient Mode available)
- Low running costs, towel drying
- Smooth temperature adjustment (10°C to 65°C)
- Thermostat can control either water temperature or ambient room temperature
- Open window detection
- Eco Design ready
- Anti-Freeze function

### TECHNICAL INFORMATION

For an all electric towel rail/radiator, fluid filling must be purchased. Electric only elements will be fitted RH side unless otherwise specified. Cable colour white & length 1.2 metre. **Suitable for electric only installation.**

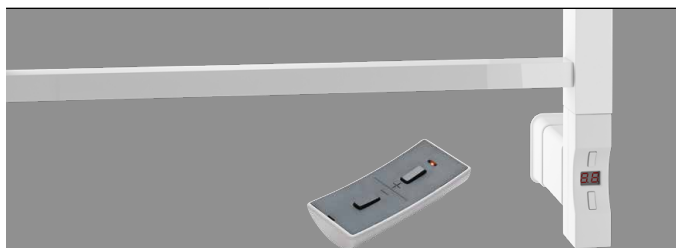

Gloss White

## Element Type F With Square Cap - Gloss White

Description	Colour	Code	£ Ex VAT	£ Inc VAT
150W Type F Element with Square Cap	Gloss White	8.384	185.00	<b>222.00</b>
300W Type F Element with Square Cap	Gloss White	8.385	191.00	<b>229.20</b>
600W Type F Element with Square Cap	Gloss White	8.386	201.00	<b>241.20</b>
900W Type F Element with Square Cap	Gloss White	8.387	206.00	<b>247.20</b>
1200W Type F Element with Square Cap	Gloss White	8.388	212.00	<b>254.40</b>
Spare Remote Controller for Type F Element		8.319	67.00	<b>80.40</b>
Fluid filling for above rail (electric only)*	-	FF	123.00	<b>147.60</b>

\*(not including appropriate element). I.P. rating 54. (Zone 2 and 3)  
Please note all fluid filled rails are special order and are **non-returnable**.



Matt Anthracite

## Element Type F With Square Cap - Matt Anthracite

Description	Colour	Code	£ Ex VAT	£ Inc VAT
150W Type F Element with Square Cap	Matt Anthracite	8.394	212.00	<b>254.40</b>
300W Type F Element with Square Cap	Matt Anthracite	8.395	216.00	<b>259.20</b>
600W Type F Element with Square Cap	Matt Anthracite	8.396	226.00	<b>271.20</b>
900W Type F Element with Square Cap	Matt Anthracite	8.397	230.00	<b>276.00</b>
1200W Type F Element with Square Cap	Matt Anthracite	8.398	236.00	<b>283.20</b>
Spare Remote Controller for Type F Element		8.319	67.00	<b>80.40</b>
Fluid filling for above rail (electric only)*	-	FF	123.00	<b>147.60</b>

\*(not including appropriate element). I.P. rating 54. (Zone 2 and 3)  
Please note all fluid filled rails are special order and are **non-returnable**.

## ELEMENT TYPE F SQUARE CAP



## WATER OR ROOM TEMPERATURE CONTROL

Suitable for electric installation only

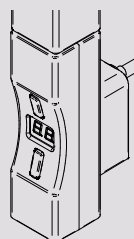

Includes remote control.



### Chrome

Power	Length (mm)
150W	300
300W	340
600W	390
900W	440
1200W	470

Turbo Boost Function

For vertical installation only. Digital temp control element including remote control.

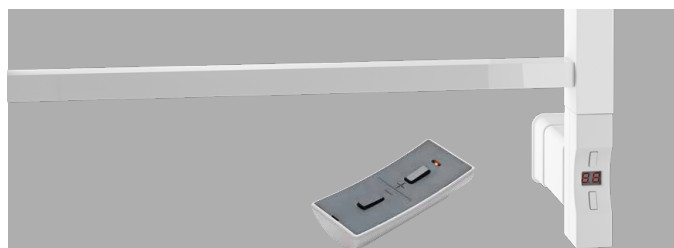

Matt White

## Element Type F With Square Cap - Matt White

Description	Colour	Code	£ Ex VAT	£ Inc VAT
150W Type F Element with Square Cap	Matt White	8.389	212.00	<b>254.40</b>
300W Type F Element with Square Cap	Matt White	8.390	216.00	<b>259.20</b>
600W Type F Element with Square Cap	Matt White	8.391	226.00	<b>271.20</b>
900W Type F Element with Square Cap	Matt White	8.392	230.00	<b>276.00</b>
1200W Type F Element with Square Cap	Matt White	8.393	236.00	<b>283.20</b>
Spare Remote Controller for Type F Element		8.319	67.00	<b>80.40</b>
Fluid filling for above rail (electric only)*	-	FF	123.00	<b>147.60</b>

\*(not including appropriate element). I.P. rating 54. (Zone 2 and 3)  
Please note all fluid filled rails are special order and are **non-returnable**.



Matt Black

## Element Type F With Square Cap - Matt Black

Description	Colour	Code	£ Ex VAT	£ Inc VAT
150W Type F Element with Square Cap	Matt Black	8.399	212.00	<b>254.40</b>
300W Type F Element with Square Cap	Matt Black	8.400	216.00	<b>259.20</b>
600W Type F Element with Square Cap	Matt Black	8.401	226.00	<b>271.20</b>
900W Type F Element with Square Cap	Matt Black	8.402	230.00	<b>276.00</b>
1200W Type F Element with Square Cap	Matt Black	8.403	236.00	<b>283.20</b>
Spare Remote Controller for Type F Element		8.319	67.00	<b>80.40</b>
Fluid filling for above rail (electric only)*	-	FF	123.00	<b>147.60</b>

\*(not including appropriate element). I.P. rating 54. (Zone 2 and 3)  
Please note all fluid filled rails are special order and are **non-returnable**.

# Elements

**WATER OR ROOM TEMPERATURE CONTROL**



**ELEMENT TYPE F**  
**WI-FI**  
**D SHAPE CAP**

Suitable for electric installation only

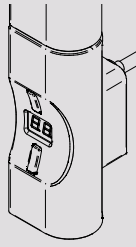



Includes remote control.





Power	Length (mm)
150W	300
300W	340
600W	390
900W	440
1200W	470

**Turbo Boost Function**

**For vertical installation only. Digital temp control element including remote control.**

**WI-FI SMARTPHONE APPLICATION**

Your WI-FI Element has the option of programming the air temperature in the daily and weekly cycles and meets the requirements of the EcoDesign Directive (Lot 20) is compatible with the EcoDirective 2018 for electric elements.







Model is distinguished by modern design, equipped with an electronic controller with an LED display. Additionally, the model is equipped with a cover covering the electrical connection.

**Download the "SUPLA" app from Google Play Store or Apple App Store.**

Video instructions for the smartphone app available on our website.

**Element Type F WiFi With D Shape Cap - Matt Anthracite**

Description	Colour	Code	£ Ex VAT	£ Inc VAT
150W Type F Element Wi-Fi with D Shape Cap	Matt Anthracite	8.489	305.00	<b>366.00</b>
300W Type F Element Wi-Fi with D Shape Cap	Matt Anthracite	8.490	311.00	<b>373.20</b>
600W Type F Element Wi-Fi with D Shape Cap	Matt Anthracite	8.491	315.00	<b>378.00</b>
900W Type F Element Wi-Fi with D Shape Cap	Matt Anthracite	8.492	325.00	<b>390.00</b>
1200W Type F Element Wi-Fi with D Shape Cap	Matt Anthracite	8.493	331.00	<b>397.20</b>
Spare Remote Controller for Type F Element		8.319	67.00	<b>80.40</b>
Fluid filling for above rail (electric only)*	-	FF	123.00	<b>147.60</b>

\*(not including appropriate element). I.P. rating 54. (Zone 2 and 3)  
Please note all fluid filled rails are special order and are **non-returnable**.

**Element Type F WiFi With D Shape Cap - Chrome**

Description	Colour	Code	£ Ex VAT	£ Inc VAT
150W Type F Element Wi-Fi with D Shape Cap	Chrome	8.479	296.00	<b>355.20</b>
300W Type F Element Wi-Fi with D Shape Cap	Chrome	8.480	302.00	<b>362.40</b>
600W Type F Element Wi-Fi with D Shape Cap	Chrome	8.481	306.00	<b>367.20</b>
900W Type F Element Wi-Fi with D Shape Cap	Chrome	8.482	310.00	<b>372.00</b>
1200W Type F Element Wi-Fi with D Shape Cap	Chrome	8.483	317.00	<b>380.40</b>
Spare Remote Controller for Type F Element		8.319	67.00	<b>80.40</b>
Fluid filling for above rail (electric only)*	-	FF	123.00	<b>147.60</b>

\*(not including appropriate element). I.P. rating 54. (Zone 2 and 3)  
Please note all fluid filled rails are special order and are **non-returnable**.

**FEATURES**

- Wi-Fi & App Control
- Comes with remote control, that acts as ambient temperature sensor
- Turbo boost function (1-3 hours)
- Off season heating
- Cable connection cover included
- Anti-Freeze function
- Daily & weekly programmable (only on Ambient Mode available)
- Low running costs, towel drying
- Smooth temperature adjustment (10°C - 65°C)
- Thermostat can control either water temperature or ambient room temperature
- Open window detection
- Eco Design ready

**TECHNICAL INFORMATION**

For an all electric towel rail/radiator, fluid filling must be purchased. Electric only elements will be fitted RH side unless otherwise specified. Cable colour white & length 1.2 metre. **Suitable for electric only installation.**

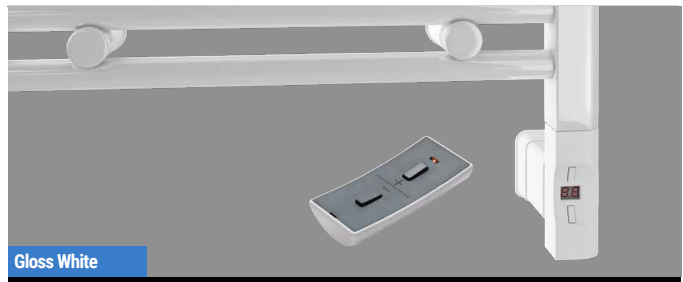

**Element Type F WiFi With D Shape Cap - Gloss White**

Description	Colour	Code	£ Ex VAT	£ Inc VAT
150W Type F Element Wi-Fi with D Shape Cap	Gloss White	8.484	282.00	<b>338.40</b>
300W Type F Element Wi-Fi with D Shape Cap	Gloss White	8.485	288.00	<b>345.60</b>
600W Type F Element Wi-Fi with D Shape Cap	Gloss White	8.486	292.00	<b>350.40</b>
900W Type F Element Wi-Fi with D Shape Cap	Gloss White	8.487	302.00	<b>362.40</b>
1200W Type F Element Wi-Fi with D Shape Cap	Gloss White	8.488	308.00	<b>369.60</b>
Spare Remote Controller for Type F Element		8.319	67.00	<b>80.40</b>
Fluid filling for above rail (electric only)*	-	FF	123.00	<b>147.60</b>

\*(not including appropriate element). I.P. rating 54. (Zone 2 and 3)  
Please note all fluid filled rails are special order and are **non-returnable**.

**Element Type F WiFi With D Shape Cap - Matt Black**

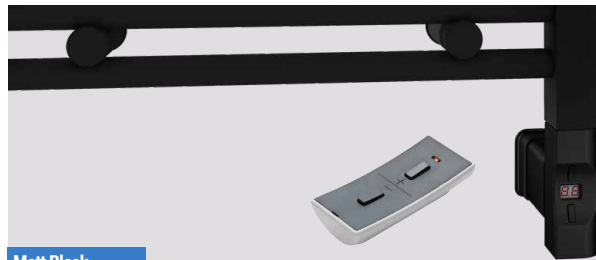
Description	Colour	Code	£ Ex VAT	£ Inc VAT
150W Type F Element Wi-Fi with D Shape Cap	Matt Black	8.494	305.00	<b>366.00</b>
300W Type F Element Wi-Fi with D Shape Cap	Matt Black	8.495	311.00	<b>373.20</b>
600W Type F Element Wi-Fi with D Shape Cap	Matt Black	8.496	315.00	<b>378.00</b>
900W Type F Element Wi-Fi with D Shape Cap	Matt Black	8.497	325.00	<b>390.00</b>
1200W Type F Element Wi-Fi with D Shape Cap	Matt Black	8.498	331.00	<b>397.20</b>
Spare Remote Controller for Type F Element		8.319	67.00	<b>80.40</b>
Fluid filling for above rail (electric only)*	-	FF	123.00	<b>147.60</b>

\*(not including appropriate element). I.P. rating 54. (Zone 2 and 3)  
Please note all fluid filled rails are special order and are **non-returnable**.



**Element Type F WiFi With Round Cap - Chrome**

Description	Colour	Code	£ Ex VAT	£ Inc VAT
150W Type F Element Wi-Fi with Round Cap	Chrome	8.499	296.00	<b>355.20</b>
300W Type F Element Wi-Fi with Round Cap	Chrome	8.500	302.00	<b>362.40</b>
600W Type F Element Wi-Fi with Round Cap	Chrome	8.501	306.00	<b>367.20</b>
900W Type F Element Wi-Fi with Round Cap	Chrome	8.502	310.00	<b>372.00</b>
1200W Type F Element Wi-Fi with Round Cap	Chrome	8.503	317.00	<b>380.40</b>
Spare Remote Controller for Type F Element		8.319	67.00	<b>80.40</b>
Fluid filling for above rail (electric only)*	-	FF	123.00	<b>147.60</b>

\*(not including appropriate element). I.P. rating 54. (Zone 2 and 3)

Please note all fluid filled rails are special order and are **non-returnable**.

**FEATURES**

- Wi-Fi & App Control
- Comes with remote control, that acts as ambient temperature sensor
- Turbo boost function (1-3 hours)
- Off season heating
- Cable connection cover included
- Anti-Freeze function
- Daily & weekly programmable (only on Ambient Mode available)
- Low running costs, towel drying
- Smooth temperature adjustment (10°C - 65°C)
- Thermostat can control either water temperature or ambient room temperature
- Open window detection
- Eco Design ready

**TECHNICAL INFORMATION**

For an all electric towel rail/radiator, fluid filling must be purchased. Electric only elements will be fitted RH side unless otherwise specified. Cable colour white & length 1.2 metre. **Suitable for electric only installation.**

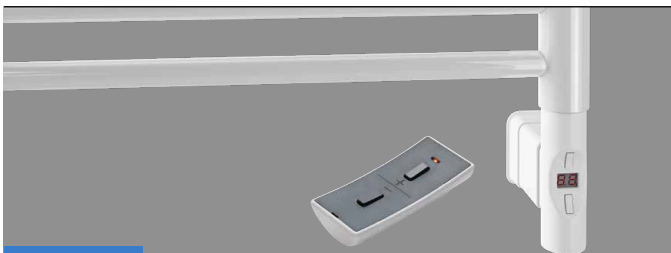

Gloss White

**Element Type F WiFi With Round Cap - Gloss White**

Description	Colour	Code	£ Ex VAT	£ Inc VAT
150W Type F Element Wi-Fi with Round Cap	Gloss White	8.504	282.00	<b>338.40</b>
300W Type F Element Wi-Fi with Round Cap	Gloss White	8.505	288.00	<b>345.60</b>
600W Type F Element Wi-Fi with Round Cap	Gloss White	8.506	292.00	<b>350.40</b>
900W Type F Element Wi-Fi with Round Cap	Gloss White	8.507	302.00	<b>362.40</b>
1200W Type F Element Wi-Fi with Round Cap	Gloss White	8.508	308.00	<b>369.60</b>
Spare Remote Controller for Type F Element		8.319	67.00	<b>80.40</b>
Fluid filling for above rail (electric only)*	-	FF	123.00	<b>147.60</b>

\*(not including appropriate element). I.P. rating 54. (Zone 2 and 3)

Please note all fluid filled rails are special order and are **non-returnable**.

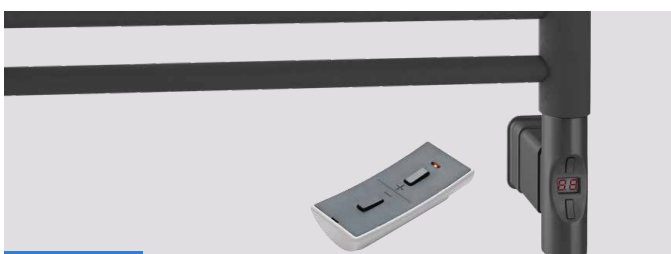

Matt Anthracite

**Element Type F WiFi With Round Cap - Matt Anthracite**

Description	Colour	Code	£ Ex VAT	£ Inc VAT
150W Type F Element Wi-Fi with Round Cap	Matt Anthracite	8.509	305.00	<b>366.00</b>
300W Type F Element Wi-Fi with Round Cap	Matt Anthracite	8.510	311.00	<b>373.20</b>
600W Type F Element Wi-Fi with Round Cap	Matt Anthracite	8.511	315.00	<b>378.00</b>
900W Type F Element Wi-Fi with Round Cap	Matt Anthracite	8.512	325.00	<b>390.00</b>
1200W Type F Element Wi-Fi with Round Cap	Matt Anthracite	8.513	331.00	<b>397.20</b>
Spare Remote Controller for Type F Element		8.319	67.00	<b>80.40</b>
Fluid filling for above rail (electric only)*	-	FF	123.00	<b>147.60</b>

\*(not including appropriate element). I.P. rating 54. (Zone 2 and 3)

Please note all fluid filled rails are special order and are **non-returnable**.

**ELEMENT TYPE F  
WI-FI  
ROUND CAP****WATER OR ROOM  
TEMPERATURE  
CONTROL**

Suitable for electric installation only



Chrome

Power	Length (mm)
150W	300
300W	340
600W	390
900W	440
1200W	470

Turbo Boost Function

For vertical installation only.  
Digital temp control element  
including remote control.

**WI-FI SMARTPHONE  
APPLICATION**

Your WiFi Element has the option of programming the air temperature in the daily and weekly cycles and meets the requirements of the EcoDesign Directive (Lot 20) is compatible with the EcoDirective 2018 for electric elements.



Model is distinguished by modern design, equipped with an electronic controller with an LED display. Additionally, the model is equipped with a cover covering the electrical connection.

Download the "SUPLA" app from [Google Play Store](#) or [Apple App Store](#).

Video instructions for the smartphone app available on our website.



Matt Black

**Element Type F WiFi With Round Cap - Matt Black**

Description	Colour	Code	£ Ex VAT	£ Inc VAT
150W Type F Element Wi-Fi with Round Cap	Matt Black	8.514	305.00	<b>366.00</b>
300W Type F Element Wi-Fi with Round Cap	Matt Black	8.515	311.00	<b>373.20</b>
600W Type F Element Wi-Fi with Round Cap	Matt Black	8.516	315.00	<b>378.00</b>
900W Type F Element Wi-Fi with Round Cap	Matt Black	8.517	325.00	<b>390.00</b>
1200W Type F Element Wi-Fi with Round Cap	Matt Black	8.518	331.00	<b>397.20</b>
Spare Remote Controller for Type F Element		8.319	67.00	<b>80.40</b>
Fluid filling for above rail (electric only)*	-	FF	123.00	<b>147.60</b>

\*(not including appropriate element). I.P. rating 54. (Zone 2 and 3)

Please note all fluid filled rails are special order and are **non-returnable**.



# Elements

**WATER OR ROOM TEMPERATURE CONTROL**



**ELEMENT TYPE F  
WI-FI  
SQUARE CAP**

Suitable for electric installation only

Includes remote control.

Power	Length (mm)
150W	300
300W	340
600W	390
900W	440
1200W	470

**Turbo Boost Function**

**For vertical installation only. Digital temp control element including remote control.**

**Element Type F WiFi With Square Cap - Chrome**

Description	Colour	Code	£ Ex VAT	£ Inc VAT
150W Type F Element Wi-Fi with Square Cap	Chrome	8.519	296.00	<b>355.20</b>
300W Type F Element Wi-Fi with Square Cap	Chrome	8.520	302.00	<b>362.40</b>
600W Type F Element Wi-Fi with Square Cap	Chrome	8.521	306.00	<b>367.20</b>
900W Type F Element Wi-Fi with Square Cap	Chrome	8.522	310.00	<b>372.00</b>
1200W Type F Element Wi-Fi with Square Cap	Chrome	8.523	317.00	<b>380.40</b>
Spare Remote Controller for Type F Element		8.319	67.00	<b>80.40</b>
Fluid filling for above rail (electric only)*	-	FF	123.00	<b>147.60</b>

\*(not including appropriate element). I.P. rating 54. (Zone 2 and 3)  
Please note all fluid filled rails are special order and are **non-returnable**.

**FEATURES**

- Wi-Fi & App Control
- Comes with remote control, that acts as ambient temperature sensor
- Turbo boost function (1-3 hours)
- Off season heating
- Cable connection cover included

- Anti-Freeze function
- Daily & weekly programmable (only on Ambient Mode available)
- Low running costs, towel drying
- Smooth temperature adjustment (10°C - 65°C)
- Thermostat can control either water temperature or ambient room temperature
- Open window detection
- Eco Design ready

**TECHNICAL INFORMATION**

For an all electric towel rail/radiator, fluid filling must be purchased. Electric only elements will be fitted RH side unless otherwise specified. Cable colour white & length 1.2 metre. **Suitable for electric only installation.**

**WI-FI SMARTPHONE APPLICATION**



Your WiFi Element has the option of programming the air temperature in the daily and weekly cycles and meets the requirements of the EcoDesign Directive (Lot 20) is compatible with the EcoDirective 2018 for electric elements.



Model is distinguished by modern design, equipped with an electronic controller with an LED display. Additionally, the model is equipped with a cover covering the electrical connection.

**Download the "SUPLA" app from Google Play Store or Apple App Store.**

Video instructions for the smartphone app available on our website.

**Element Type F WiFi With Square Cap - Gloss White**

Description	Colour	Code	£ Ex VAT	£ Inc VAT
150W Type F Element Wi-Fi with Square Cap	Gloss White	8.524	282.00	<b>338.40</b>
300W Type F Element Wi-Fi with Square Cap	Gloss White	8.525	288.00	<b>345.60</b>
600W Type F Element Wi-Fi with Square Cap	Gloss White	8.526	292.00	<b>350.40</b>
900W Type F Element Wi-Fi with Square Cap	Gloss White	8.527	302.00	<b>362.40</b>
1200W Type F Element Wi-Fi with Square Cap	Gloss White	8.528	308.00	<b>369.60</b>
Spare Remote Controller for Type F Element		8.319	67.00	<b>80.40</b>
Fluid filling for above rail (electric only)*	-	FF	123.00	<b>147.60</b>

\*(not including appropriate element). I.P. rating 54. (Zone 2 and 3)  
Please note all fluid filled rails are special order and are **non-returnable**.

**Element Type F WiFi With Square Cap - Matt Anthracite**

Description	Colour	Code	£ Ex VAT	£ Inc VAT
150W Type F Element Wi-Fi with Square Cap	Matt Anthracite	8.529	305.00	<b>366.00</b>
300W Type F Element Wi-Fi with Square Cap	Matt Anthracite	8.530	311.00	<b>373.20</b>
600W Type F Element Wi-Fi with Square Cap	Matt Anthracite	8.531	315.00	<b>378.00</b>
900W Type F Element Wi-Fi with Square Cap	Matt Anthracite	8.532	325.00	<b>390.00</b>
1200W Type F Element Wi-Fi with Square Cap	Matt Anthracite	8.533	331.00	<b>397.20</b>
Spare Remote Controller for Type F Element		8.319	67.00	<b>80.40</b>
Fluid filling for above rail (electric only)*	-	FF	123.00	<b>147.60</b>

\*(not including appropriate element). I.P. rating 54. (Zone 2 and 3)  
Please note all fluid filled rails are special order and are **non-returnable**.

**Element Type F WiFi With Square Cap - Matt Black**

Description	Colour	Code	£ Ex VAT	£ Inc VAT
150W Type F Element Wi-Fi with Square Cap	Matt Black	8.534	305.00	<b>366.00</b>
300W Type F Element Wi-Fi with Square Cap	Matt Black	8.535	311.00	<b>373.20</b>
600W Type F Element Wi-Fi with Square Cap	Matt Black	8.536	315.00	<b>378.00</b>
900W Type F Element Wi-Fi with Square Cap	Matt Black	8.537	325.00	<b>390.00</b>
1200W Type F Element Wi-Fi with Square Cap	Matt Black	8.538	331.00	<b>397.20</b>
Spare Remote Controller for Type F Element		8.319	67.00	<b>80.40</b>
Fluid filling for above rail (electric only)*	-	FF	123.00	<b>147.60</b>

\*(not including appropriate element). I.P. rating 54. (Zone 2 and 3)  
Please note all fluid filled rails are special order and are **non-returnable**.

# Elements

Element Type G With D Shape Cap - Chrome				
Description	Colour	Code	£ Ex VAT	£ Inc VAT
150W Type G Element with D Shape Cap	Chrome	8.404	171.00	<b>205.20</b>
300W Type G Element with D Shape Cap	Chrome	8.405	177.00	<b>212.40</b>
600W Type G Element with D Shape Cap	Chrome	8.406	185.00	<b>222.00</b>
900W Type G Element with D Shape Cap	Chrome	8.407	195.00	<b>234.00</b>
1200W Type G Element with D Shape Cap	Chrome	8.408	201.00	<b>241.20</b>
Fluid filling for above rail (electric only)*	-	FF	123.00	<b>147.60</b>

\*(not including appropriate element). I.P. rating 54. (Zone 2 and 3)  
Please note all fluid filled rails are special order and are **non-returnable**.

- FEATURES**
- Timer 1-9 hour
  - Turbo boost function
  - Off season heating
  - Cable connection cover included
  - Anti-Freeze function
  - Maintains previously selected temperature for a period of 1-9 hours
  - Low running costs, towel drying
  - Smooth temperature adjustment (10°C to 65°C)
  - Water temperature controlled Thermostat

**TECHNICAL INFORMATION**

For an all electric towel rail/radiator, fluid filling must be purchased. Electric only elements will be fitted RH side unless otherwise specified. Cable colour white & length 1.2 metre. **Suitable for electric only installation.**

## ELEMENT TYPE G WITH D SHAPE CAP WATER TEMPERATURE CONTROL

Suitable for electric installation only



Chrome

Power	Length (mm)
150W	300
300W	340
600W	390
900W	440
1200W	470

Turbo Boost Function

For vertical installation only.  
Digital temp control element.

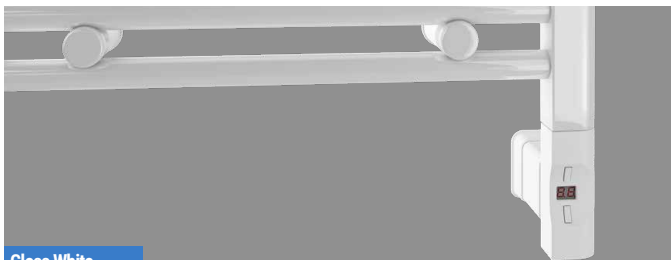

Gloss White

Element Type G With D Shape Cap - Gloss White				
Description	Colour	Code	£ Ex VAT	£ Inc VAT
150W Type G Element with D Shape Cap	Gloss White	8.409	161.00	<b>193.20</b>
300W Type G Element with D Shape Cap	Gloss White	8.410	166.00	<b>199.20</b>
600W Type G Element with D Shape Cap	Gloss White	8.411	177.00	<b>212.40</b>
900W Type G Element with D Shape Cap	Gloss White	8.412	181.00	<b>217.20</b>
1200W Type G Element with D Shape Cap	Gloss White	8.413	185.00	<b>222.00</b>
Fluid filling for above rail (electric only)*	-	FF	123.00	<b>147.60</b>

\*(not including appropriate element). I.P. rating 54. (Zone 2 and 3)  
Please note all fluid filled rails are special order and are **non-returnable**.

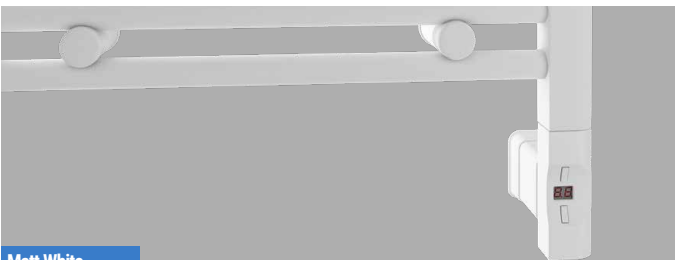

Matt White

Element Type G With D Shape Cap - Matt White				
Description	Colour	Code	£ Ex VAT	£ Inc VAT
150W Type G Element with D Shape Cap	Matt White	8.414	185.00	<b>222.00</b>
300W Type G Element with D Shape Cap	Matt White	8.415	191.00	<b>229.20</b>
600W Type G Element with D Shape Cap	Matt White	8.416	201.00	<b>241.20</b>
900W Type G Element with D Shape Cap	Matt White	8.417	206.00	<b>247.20</b>
1200W Type G Element with D Shape Cap	Matt White	8.418	212.00	<b>254.40</b>
Fluid filling for above rail (electric only)*	-	FF	123.00	<b>147.60</b>

\*(not including appropriate element). I.P. rating 54. (Zone 2 and 3)  
Please note all fluid filled rails are special order and are **non-returnable**.

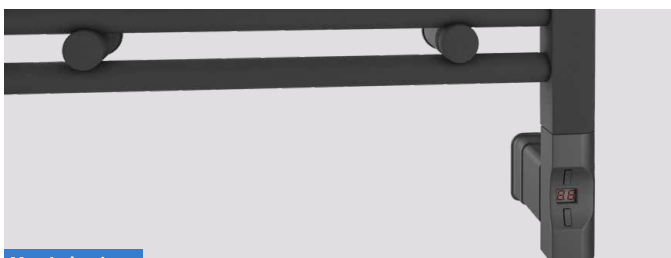

Matt Anthracite

Element Type G With D Shape Cap - Matt Anthracite				
Description	Colour	Code	£ Ex VAT	£ Inc VAT
150W Type G Element with D Shape Cap	Matt Anthracite	8.419	185.00	<b>222.00</b>
300W Type G Element with D Shape Cap	Matt Anthracite	8.420	191.00	<b>229.20</b>
600W Type G Element with D Shape Cap	Matt Anthracite	8.421	201.00	<b>241.20</b>
900W Type G Element with D Shape Cap	Matt Anthracite	8.422	206.00	<b>247.20</b>
1200W Type G Element with D Shape Cap	Matt Anthracite	8.423	212.00	<b>254.40</b>
Fluid filling for above rail (electric only)*	-	FF	123.00	<b>147.60</b>

\*(not including appropriate element). I.P. rating 54. (Zone 2 and 3)  
Please note all fluid filled rails are special order and are **non-returnable**.

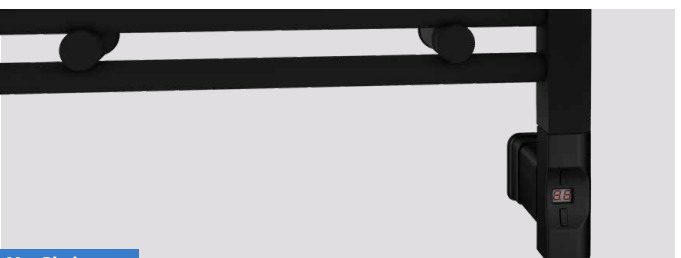

Matt Black

Element Type G With D Shape Cap - Matt Black				
Description	Colour	Code	£ Ex VAT	£ Inc VAT
150W Type G Element with D Shape Cap	Matt Black	8.424	185.00	<b>222.00</b>
300W Type G Element with D Shape Cap	Matt Black	8.425	191.00	<b>229.20</b>
600W Type G Element with D Shape Cap	Matt Black	8.426	201.00	<b>241.20</b>
900W Type G Element with D Shape Cap	Matt Black	8.427	206.00	<b>247.20</b>
1200W Type G Element with D Shape Cap	Matt Black	8.428	212.00	<b>254.40</b>
Fluid filling for above rail (electric only)*	-	FF	123.00	<b>147.60</b>

\*(not including appropriate element). I.P. rating 54. (Zone 2 and 3)  
Please note all fluid filled rails are special order and are **non-returnable**.

# Elements

**ELEMENT TYPE G WITH ROUND CAP WATER TEMPERATURE CONTROL**

Suitable for electric installation only



**Chrome**

Power	Length (mm)
150W	300
300W	340
600W	390
900W	440
1200W	470

Turbo Boost Function

For vertical installation only. Digital temp control element.

**Element Type G With Round Cap - Chrome**

Description	Colour	Code	£ Ex VAT	£ Inc VAT
150W Type G Element with Round Cap	Chrome	8.429	171.00	<b>205.20</b>
300W Type G Element with Round Cap	Chrome	8.430	177.00	<b>212.40</b>
600W Type G Element with Round Cap	Chrome	8.431	185.00	<b>222.00</b>
900W Type G Element with Round Cap	Chrome	8.432	195.00	<b>234.00</b>
1200W Type G Element with Round Cap	Chrome	8.433	201.00	<b>241.20</b>
Fluid filling for above rail (electric only)*	-	FF	123.00	<b>147.60</b>

\*(not including appropriate element). I.P. rating 54. (Zone 2 and 3)  
Please note all fluid filled rails are special order and are **non-returnable**.

**FEATURES**

- Timer 1-9 hour
- Turbo boost function
- Off season heating
- Cable connection cover included
- Anti-Freeze function
- Maintains previously selected temperature for a period of 1-9 hours
- Low running costs, towel drying
- Smooth temperature adjustment (10°C to 65°C)
- Water temperature controlled Thermostat

**TECHNICAL INFORMATION**

For an all electric towel rail/radiator, fluid filling must be purchased. Electric only elements will be fitted RH side unless otherwise specified. Cable colour white & length 1.2 metre. **Suitable for electric only installation.**



**Gloss White**

**Element Type G With Round Cap - Gloss White**

Description	Colour	Code	£ Ex VAT	£ Inc VAT
150W Type G Element with Round Cap	Gloss White	8.434	161.00	<b>193.20</b>
300W Type G Element with Round Cap	Gloss White	8.435	166.00	<b>199.20</b>
600W Type G Element with Round Cap	Gloss White	8.436	177.00	<b>212.40</b>
900W Type G Element with Round Cap	Gloss White	8.437	181.00	<b>217.20</b>
1200W Type G Element with Round Cap	Gloss White	8.438	185.00	<b>222.00</b>
Fluid filling for above rail (electric only)*	-	FF	123.00	<b>147.60</b>

\*(not including appropriate element). I.P. rating 54. (Zone 2 and 3)  
Please note all fluid filled rails are special order and are **non-returnable**.



**Matt White**

**Element Type G With Round Cap - Matt White**

Description	Colour	Code	£ Ex VAT	£ Inc VAT
150W Type G Element with Round Cap	Matt White	8.439	185.00	<b>222.00</b>
300W Type G Element with Round Cap	Matt White	8.440	191.00	<b>229.20</b>
600W Type G Element with Round Cap	Matt White	8.441	201.00	<b>241.20</b>
900W Type G Element with Round Cap	Matt White	8.442	206.00	<b>247.20</b>
1200W Type G Element with Round Cap	Matt White	8.443	212.00	<b>254.40</b>
Fluid filling for above rail (electric only)*	-	FF	123.00	<b>147.60</b>

\*(not including appropriate element). I.P. rating 54. (Zone 2 and 3)  
Please note all fluid filled rails are special order and are **non-returnable**.



**Matt Anthracite**

**Element Type G With Round Cap - Matt Anthracite**

Description	Colour	Code	£ Ex VAT	£ Inc VAT
150W Type G Element with Round Cap	Matt Anthracite	8.444	185.00	<b>222.00</b>
300W Type G Element with Round Cap	Matt Anthracite	8.445	191.00	<b>229.20</b>
600W Type G Element with Round Cap	Matt Anthracite	8.446	201.00	<b>241.20</b>
900W Type G Element with Round Cap	Matt Anthracite	8.447	206.00	<b>247.20</b>
1200W Type G Element with Round Cap	Matt Anthracite	8.448	212.00	<b>254.40</b>
Fluid filling for above rail (electric only)*	-	FF	123.00	<b>147.60</b>

\*(not including appropriate element). I.P. rating 54. (Zone 2 and 3)  
Please note all fluid filled rails are special order and are **non-returnable**.



**Matt Black**

**Element Type G With Round Cap - Matt Black**

Description	Colour	Code	£ Ex VAT	£ Inc VAT
150W Type G Element with Round Cap	Matt Black	8.449	185.00	<b>222.00</b>
300W Type G Element with Round Cap	Matt Black	8.450	191.00	<b>229.20</b>
600W Type G Element with Round Cap	Matt Black	8.451	201.00	<b>241.20</b>
900W Type G Element with Round Cap	Matt Black	8.452	206.00	<b>247.20</b>
1200W Type G Element with Round Cap	Matt Black	8.453	212.00	<b>254.40</b>
Fluid filling for above rail (electric only)*	-	FF	123.00	<b>147.60</b>

\*(not including appropriate element). I.P. rating 54. (Zone 2 and 3)  
Please note all fluid filled rails are special order and are **non-returnable**.

# Elements

## Element Type G With Square Cap - Chrome

Description	Colour	Code	£ Ex VAT	£ Inc VAT
150W Type G Element with Square Cap	Chrome	8.454	171.00	205.20
300W Type G Element with Square Cap	Chrome	8.455	177.00	212.40
600W Type G Element with Square Cap	Chrome	8.456	185.00	222.00
900W Type G Element with Square Cap	Chrome	8.457	195.00	234.00
1200W Type G Element with Square Cap	Chrome	8.458	201.00	241.20
Fluid filling for above rail (electric only)*	-	FF	123.00	147.60

\*(not including appropriate element). I.P. rating 54. (Zone 2 and 3)

Please note all fluid filled rails are special order and are **non-returnable**.

### FEATURES

- Timer 1-9 hour
- Turbo boost function
- Off season heating
- Cable connection cover included
- Anti-Freeze function
- Maintains previously selected temperature for a period of 1-9 hours
- Low running costs, towel drying
- Smooth temperature adjustment (10°C to 65°C)
- Water temperature controlled Thermostat

### TECHNICAL INFORMATION

For an all electric towel rail/radiator, fluid filling must be purchased. Electric only elements will be fitted RH side unless otherwise specified. Cable colour white & length 1.2 metre. **Suitable for electric only installation.**



Gloss White

## Element Type G With Square Cap - Gloss White

Description	Colour	Code	£ Ex VAT	£ Inc VAT
150W Type G Element with Square Cap	Gloss White	8.459	161.00	193.20
300W Type G Element with Square Cap	Gloss White	8.460	166.00	199.20
600W Type G Element with Square Cap	Gloss White	8.461	177.00	212.40
900W Type G Element with Square Cap	Gloss White	8.462	181.00	217.20
1200W Type G Element with Square Cap	Gloss White	8.463	185.00	222.00
Fluid filling for above rail (electric only)*	-	FF	123.00	147.60

\*(not including appropriate element). I.P. rating 54. (Zone 2 and 3)

Please note all fluid filled rails are special order and are **non-returnable**.

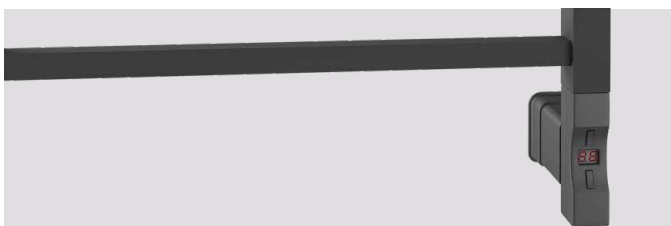

Matt Anthracite

## Element Type G With Square Cap - Matt Anthracite

Description	Colour	Code	£ Ex VAT	£ Inc VAT
150W Type G Element with Square Cap	Matt Anthracite	8.469	185.00	222.00
300W Type G Element with Square Cap	Matt Anthracite	8.470	191.00	229.20
600W Type G Element with Square Cap	Matt Anthracite	8.471	201.00	241.20
900W Type G Element with Square Cap	Matt Anthracite	8.472	206.00	247.20
1200W Type G Element with Square Cap	Matt Anthracite	8.473	212.00	254.40
Fluid filling for above rail (electric only)*	-	FF	123.00	147.60

\*(not including appropriate element). I.P. rating 54. (Zone 2 and 3)

Please note all fluid filled rails are special order and are **non-returnable**.

## ELEMENT TYPE G WITH SQUARE CAP

## WATER TEMPERATURE CONTROL

Suitable for electric installation only



Chrome

Power	Length (mm)
150W	300
300W	340
600W	390
900W	440
1200W	470

Turbo Boost Function

For vertical installation only.  
Digital temp control element.



Matt White

## Element Type G With Square Cap - Matt White

Description	Colour	Code	£ Ex VAT	£ Inc VAT
150W Type G Element with Square Cap	Matt White	8.464	185.00	222.00
300W Type G Element with Square Cap	Matt White	8.465	191.00	229.20
600W Type G Element with Square Cap	Matt White	8.466	201.00	241.20
900W Type G Element with Square Cap	Matt White	8.467	206.00	247.20
1200W Type G Element with Square Cap	Matt White	8.468	212.00	254.40
Fluid filling for above rail (electric only)*	-	FF	123.00	147.60

\*(not including appropriate element). I.P. rating 54. (Zone 2 and 3)

Please note all fluid filled rails are special order and are **non-returnable**.

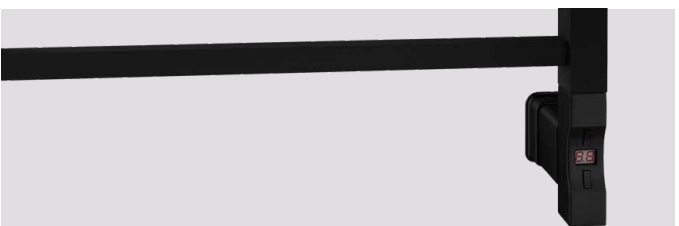

Matt Black

## Element Type G With Square Cap - Matt Black

Description	Colour	Code	£ Ex VAT	£ Inc VAT
150W Type G Element with Square Cap	Matt Black	8.474	185.00	222.00
300W Type G Element with Square Cap	Matt Black	8.475	191.00	229.20
600W Type G Element with Square Cap	Matt Black	8.476	201.00	241.20
900W Type G Element with Square Cap	Matt Black	8.477	206.00	247.20
1200W Type G Element with Square Cap	Matt Black	8.478	212.00	254.40
Fluid filling for above rail (electric only)*	-	FF	123.00	147.60

\*(not including appropriate element). I.P. rating 54. (Zone 2 and 3)

Please note all fluid filled rails are special order and are **non-returnable**.

### All Eastbrook fluid filled rails are filled with Fernox HP-5.

With over 40 years experience and continual investment in research and development, Fernox water treatment products are manufactured to the highest quality, reliability and performance. Fernox HP-5 is a pre-blended heat transfer fluid which gives a frost protection down to -5°C. It also provides long-term protection from damage caused by corrosion, limescale and bacteria and maintains a stable pH across a range of operational temperatures.

### FEATURES - FERNOX

- Anti-cavitation (lower noise)
- Better heat transfer
- Anti-corrosion properties
- Anti-freeze



# Elements

## WATER OR ROOM TEMPERATURE CONTROL

Power	Length (mm)
300W	340
600W	390
900W	440
1200W	470



Includes remote control.

### Element Type H Horizontal - Chrome

Description	Colour	Code	£ Ex VAT	£ Inc VAT
300W Type H Element Horizontal**	Chrome	8.554	303.00	<b>363.60</b>
600W Type H Element Horizontal**	Chrome	8.555	308.00	<b>369.60</b>
900W Type H Element Horizontal**	Chrome	8.556	312.00	<b>374.40</b>
1200W Type H Element Horizontal**	Chrome	8.557	318.00	<b>381.60</b>
Fluid filling for above rail (electric only)*	-	FF	123.00	<b>147.60</b>

### Element Type H Horizontal - Matt Anthracite

Description	Colour	Code	£ Ex VAT	£ Inc VAT
300W Type H Element Horizontal**	Matt Anthracite	8.544	299.00	<b>358.80</b>
600W Type H Element Horizontal**	Matt Anthracite	8.545	303.00	<b>363.60</b>
900W Type H Element Horizontal**	Matt Anthracite	8.546	308.00	<b>369.60</b>
1200W Type H Element Horizontal**	Matt Anthracite	8.547	312.00	<b>374.40</b>
Fluid filling for above rail (electric only)*	-	FF	123.00	<b>147.60</b>

\*(not including appropriate element, for all colours). I.P. rating 54. (Zone 2 and 3) Please note all fluid filled rails are special order and are **non-returnable**.

## ELEMENT TYPE H HORIZONTAL

### FEATURES

- Turbo boost function (full heating for a set period 1, 2 or 3 hours)
- Off season heating
- Anti-Freeze function
- Low running costs
- Eco Design ready
- Smooth temperature adjustment (10°C to 65°C)
- Comes with remote control, that acts as ambient temperature sensor
- Thermostat can control either water temperature or ambient room temperature
- Can be fitted on LH or RH side by 180°C rotating thermostat

### TECHNICAL INFORMATION

For an all electric towel rail/radiator, fluid filling must be purchased. Electric only elements will be fitted RH side unless otherwise specified. **Only suitable with Chrome T-Piece - 8.901 & Chrome Elbow - 41.3003.**

### Element Type H Horizontal - Gloss White

Description	Colour	Code	£ Ex VAT	£ Inc VAT
300W Type H Element Horizontal**	Gloss White	8.539	279.00	<b>334.80</b>
600W Type H Element Horizontal**	Gloss White	8.540	283.00	<b>339.60</b>
900W Type H Element Horizontal**	Gloss White	8.541	288.00	<b>345.60</b>
1200W Type H Element Horizontal**	Gloss White	8.542	292.00	<b>350.40</b>
Fluid filling for above rail (electric only)*	-	FF	123.00	<b>147.60</b>

### Element Type H Horizontal - Matt Black

Description	Colour	Code	£ Ex VAT	£ Inc VAT
300W Type H Element Horizontal**	Matt Black	8.549	299.00	<b>358.80</b>
600W Type H Element Horizontal**	Matt Black	8.550	303.00	<b>363.60</b>
900W Type H Element Horizontal**	Matt Black	8.551	308.00	<b>369.60</b>
1200W Type H Element Horizontal**	Matt Black	8.552	312.00	<b>374.40</b>
Fluid filling for above rail (electric only)*	-	FF	123.00	<b>147.60</b>

## WATER OR ROOM TEMPERATURE CONTROL

Power	Length (mm)
300W	340
600W	390
900W	440
1200W	470



Includes remote control.

### Element Type H Wi-Fi Horizontal - Chrome

Description	Colour	Code	£ Ex VAT	£ Inc VAT
300W Type H Element Wi-Fi Horizontal**	Chrome	8.574	341.00	<b>409.20</b>
600W Type H Element Wi-Fi Horizontal**	Chrome	8.575	345.00	<b>414.00</b>
900W Type H Element Wi-Fi Horizontal**	Chrome	8.576	350.00	<b>420.00</b>
1200W Type H Element Wi-Fi Horizontal**	Chrome	8.577	354.00	<b>424.80</b>
Fluid filling for above rail (electric only)*	-	FF	123.00	<b>147.60</b>

### Element Type H Wi-Fi Horizontal - Matt Anthracite

Description	Colour	Code	£ Ex VAT	£ Inc VAT
300W Type H Element Wi-Fi Horizontal**	Matt Anthracite	8.564	335.00	<b>402.00</b>
600W Type H Element Wi-Fi Horizontal**	Matt Anthracite	8.565	341.00	<b>409.20</b>
900W Type H Element Wi-Fi Horizontal**	Matt Anthracite	8.566	345.00	<b>414.00</b>
1200W Type H Element Wi-Fi Horizontal**	Matt Anthracite	8.567	350.00	<b>420.00</b>
Fluid filling for above rail (electric only)*	-	FF	123.00	<b>147.60</b>

\*(not including appropriate element, for all colours). I.P. rating 54. (Zone 2 and 3) Please note all fluid filled rails are special order and are **non-returnable**.

## ELEMENT TYPE H WI-FI HORIZONTAL

### FEATURES

- Turbo boost function (full heating for a set period 1, 2 or 3 hours)
- Off season heating
- Anti-Freeze function
- Low running costs
- Eco Design ready
- Smooth temperature adjustment (10°C to 65°C)
- Wi-Fi & App Control
- Comes with remote control, that acts as ambient temperature sensor
- Thermostat can control either water temperature or ambient room temperature
- Can be fitted on LH or RH side by 180°C rotating thermostat

### TECHNICAL INFORMATION

For an all electric towel rail/radiator, fluid filling must be purchased. Electric only elements will be fitted RH side unless otherwise specified. **Only suitable with Chrome T-Piece - 8.901 & Chrome Elbow - 41.3003.**

### Element Type H Wi-Fi Horizontal - Gloss White

Description	Colour	Code	£ Ex VAT	£ Inc VAT
300W Type H Element Wi-Fi Horizontal**	Gloss White	8.559	315.00	<b>378.00</b>
600W Type H Element Wi-Fi Horizontal**	Gloss White	8.560	321.00	<b>385.20</b>
900W Type H Element Wi-Fi Horizontal**	Gloss White	8.561	325.00	<b>390.00</b>
1200W Type H Element Wi-Fi Horizontal**	Gloss White	8.562	330.00	<b>396.00</b>
Fluid filling for above rail (electric only)*	-	FF	123.00	<b>147.60</b>

### Element Type H Wi-Fi Horizontal - Matt Black

Description	Colour	Code	£ Ex VAT	£ Inc VAT
300W Type H Element Wi-Fi Horizontal**	Matt Black	8.569	335.00	<b>402.00</b>
600W Type H Element Wi-Fi Horizontal**	Matt Black	8.570	341.00	<b>409.20</b>
900W Type H Element Wi-Fi Horizontal**	Matt Black	8.571	345.00	<b>414.00</b>
1200W Type H Element Wi-Fi Horizontal**	Matt Black	8.572	350.00	<b>420.00</b>
Fluid filling for above rail (electric only)*	-	FF	123.00	<b>147.60</b>

## WI-FI SMARTPHONE APPLICATION



Your WiFi Element has the option of programming the air temperature in the daily and weekly cycles and meets the requirements of the EcoDesign Directive (Lot 20) is compatible with the EcoDirective 2018 for electric elements.

Download the "SUPLA" app from [Google Play Store](#) or [Apple App Store](#). Video instructions for the smartphone app available on our website.

# Crafton Control Plate & Thermostatic Valves

## Crafton Temperature Control Panel

Description	Code	£ Ex VAT	£ Inc VAT
Crafton Temperature Control Plate White	67.0004	113.00	<b>135.60</b>
Crafton Temperature Control Plate Chrome Cover	67.0005	38.00	<b>45.60</b>

### FEATURES

- Can be fitted in the bathroom (Zone 2 rated)
- IPX5 rated
- Active LED display
- 2 hour boost function
- Low running costs
- Wattage range 100-1000 watts
- 20-100% output control
- Can be used on dual fuel and electric only installations
- **Can only be fitted with Type A+ / A+ Eco, Type A Element and Biava Dry Element towel rail**
- Will fit all standard electrical back boxes

## CRAFTON TEMPERATURE CONTROL PANEL

Additional Chrome Cover 67.0005



## Dual Fuel - Element T Pieces & Elbows



### Dual Fuel Elbows

Description	Code	£ Ex VAT	£ Inc VAT
Elbow Chrome	41.3003	17.00	<b>20.40</b>
Elbow Matt White	41.4040	19.00	<b>22.80</b>
Elbow Matt Grey	41.4041	19.00	<b>22.80</b>
Elbow Matt Cappuccino	41.4042	19.00	<b>22.80</b>
Elbow Matt Anthracite	41.4043	19.00	<b>22.80</b>
Elbow Matt Black	41.4044	19.00	<b>22.80</b>
<b>NEW!</b> Elbow Brushed Brass	41.0607	19.00	<b>22.80</b>

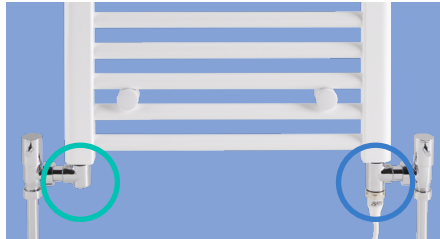

**New Brushed Brass due in November 2023**

### Dual Fuel T Pieces

Description	Code	£ Ex VAT	£ Inc VAT
T Piece Chrome	8.901	18.00	<b>21.60</b>
T Piece Matt White	41.3030	23.00	<b>27.60</b>
T Piece Matt Grey	41.3031	23.00	<b>27.60</b>
T Piece Matt Cappuccino	41.3032	23.00	<b>27.60</b>
T Piece Matt Anthracite	41.3033	23.00	<b>27.60</b>
T Piece Matt Black	41.3034	23.00	<b>27.60</b>
<b>NEW!</b> T Piece Brushed Brass	41.0606	21.00	<b>25.20</b>

## Corner Dual Fuel Thermostatic Valve & Lockshield Valve

### 15mm Corner Dual Fuel TRV & Lockshield Valve Chrome

Description	Colour	Code	£ Ex VAT	£ Inc VAT
Dual Fuel TRV and Lockshield Valve 15mm	Chrome	12.058	78.00	<b>93.60</b>
Dual Fuel TRV and Lockshield Valve 15mm	Matt White	54.0026	74.00	<b>88.80</b>
Dual Fuel TRV and Lockshield Valve 15mm	Matt Anthracite	54.0027	74.00	<b>88.80</b>
Dual Fuel TRV and Lockshield Valve 15mm	Matt Black	54.0028	74.00	<b>88.80</b>
Dual Fuel TRV and Lockshield Valve 15mm	Brushed Brass	41.0608	81.00	<b>97.20</b>

### FEATURES

- Approved to EN215
- Produced to ISO 9001:2008
- Integrated T Piece
- Only fitted with Type A & A+ Elements
- Element entry inlets from both sides
- Brass construction
- 2 Year Warranty\*
- \*With conditions

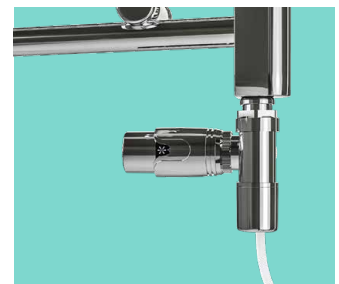

# Valve Buying Guide

## Radiator Valve Buying Guide

### Step 1

Choose your towel rail or radiator. Remember to check where your central heating pipework is located.

### Step 2

Check which type of connection your chosen radiator has. (Side or bottom connection).

### Step 3

Choose from one of the below valve types which compatible with your pipework.

### Angled Valves

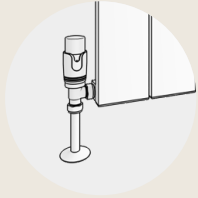

[Manual Options P306 & 307](#)  
[Thermostatic \(TRV\) Options P303, 304, 305, 308 & 309](#)

#### FEATURES

- Most used valve type.
- Connects radiator at 90° angle.
- Pipework can be from the wall or floor.

#### COMPATIBLE WITH:

- Connections at the sides & pipework from the floor.
- Connections at the sides & pipework from the wall.
- Connections at the bottom & pipework from the wall.



### Corner Valves

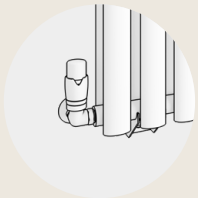

[Manual Options P306 & 307](#)  
[Thermostatic \(TRV\) Options P303, 304, 305 & 309](#)

#### FEATURES

- Connects radiator at 90° angle.
- On side connections, valve head sits vertically.
- On bottom connections, valve head sits under the radiator.

#### COMPATIBLE WITH:

- Connections at the sides & pipework from the wall.
- Connections at the bottom & pipework from the wall.



### Straight Valves

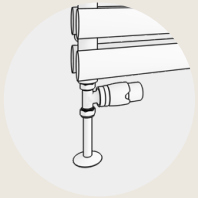

[Manual Options P305](#)  
[Thermostatic \(TRV\) Options P303, 304, 305 & 308](#)

#### FEATURES

- Fits best to bottom connection towel rails & radiators.
- Suitable only with bottom connection radiators & towel rails with pipework from the floor or along the wall.
- Can be connected vertically or horizontally depending on the pipework.

#### COMPATIBLE WITH:

- Connections at the bottom & pipework from the floor.



### Twin Thermostatic Valves

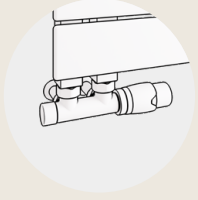

[Thermostatic \(TRV\) Options P304](#)

#### FEATURES

- Angled & Straight versions available.
- 50mm connection centres.
- Saves space by using one valve instead of two.
- Only suitable for selected models in our ranges.

#### COMPATIBLE WITH:

- Connections at the bottom & pipework from the floor.
- Connections at the bottom & pipework from the wall.

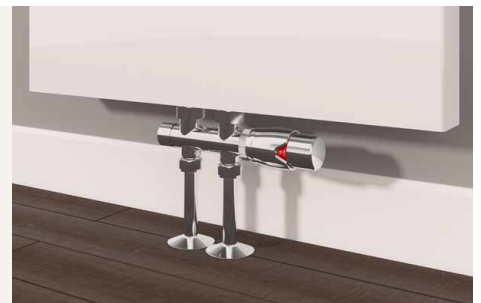

### Dual Fuel Thermostatic Valves

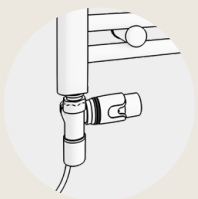

[Thermostatic \(TRV\) Options P301](#)

#### FEATURES

- Only corner version available.
- Elements can be fitted from both sides.
- Only Type A & Type A+ element can be used.

#### COMPATIBLE WITH:

- Connections at the bottom & pipework from the wall.



### Drain Off Valves

[P307](#)

- Can be used to drain off radiators.

### Pipe Shrouds & Collar Kits

[P311](#)

- 15mm pipe covering shrouds & collars for aesthetic perfection.



# Darlington Valves

## DARLINGTON STRAIGHT TRV

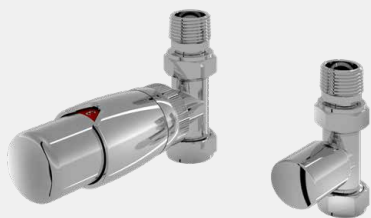

BI-DIRECTIONAL

Chrome

Straight TRV with Lockshield 15mm (pair)

Code	£ Ex VAT	£ Inc VAT
54.0003	39.00	46.80

## DARLINGTON ANGLED TRV



BI-DIRECTIONAL

Chrome

Angled TRV with Lockshield 15mm (pair)

Code	£ Ex VAT	£ Inc VAT
54.0002	38.00	45.60

## DARLINGTON CORNER TRV



BI-DIRECTIONAL

Chrome

Corner TRV with Lockshield 15mm (pair)

Code	£ Ex VAT	£ Inc VAT
54.0004	40.00	48.00



BI-DIRECTIONAL

White/Chrome

Straight TRV with Lockshield 15mm (pair)

Code	£ Ex VAT	£ Inc VAT
54.0005	40.00	48.00



BI-DIRECTIONAL

White/Chrome

Angled TRV with Lockshield 15mm (pair)

Code	£ Ex VAT	£ Inc VAT
54.0006	39.00	46.80



BI-DIRECTIONAL

White/Chrome

Corner TRV with Lockshield 15mm (pair)

Code	£ Ex VAT	£ Inc VAT
54.0007	44.00	52.80



BI-DIRECTIONAL

Matt White

Straight TRV with Lockshield 15mm (pair)

Code	£ Ex VAT	£ Inc VAT
54.0019	45.00	54.00



BI-DIRECTIONAL

Matt White

Angled TRV with Lockshield 15mm (pair)

Code	£ Ex VAT	£ Inc VAT
54.0016	44.00	52.80



BI-DIRECTIONAL

Matt White

Corner TRV with Lockshield 15mm (pair)

Code	£ Ex VAT	£ Inc VAT
54.0022	52.00	62.40



BI-DIRECTIONAL

Matt Anthracite

Straight TRV with Lockshield 15mm (pair)

Code	£ Ex VAT	£ Inc VAT
54.0020	45.00	54.00



BI-DIRECTIONAL

Matt Anthracite

Angled TRV with Lockshield 15mm (pair)

Code	£ Ex VAT	£ Inc VAT
54.0017	44.00	52.80



BI-DIRECTIONAL

Matt Anthracite

Corner TRV with Lockshield 15mm (pair)

Code	£ Ex VAT	£ Inc VAT
54.0023	52.00	62.40

### FEATURES





- Approved to EN 1074-2:2000
- Produced to GB/T 19001-2016
- Produced to ISO 9001:2015
- 2 Year warranty with conditions

### TECHNICAL INFORMATION

On all Darlington valves, the materials used can have a slight difference between their parts colours. The numbers on the TRV heads do not represent specific room temperatures as the temperature at which the valve operates depends on the water temperature flowing through the radiator, airflow around the head of the TRV, the room size and any heat loss in that space through walls, windows and floors.

# Darlington & Thermostatic Valves

DARLINGTON STRAIGHT TRV			DARLINGTON ANGLED TRV			DARLINGTON CORNER TRV		
								
<b>BI-DIRECTIONAL</b> <b>Matt Black</b>			<b>BI-DIRECTIONAL</b> <b>Matt Black</b>			<b>BI-DIRECTIONAL</b> <b>Matt Black</b>		
<b>Straight TRV with Lockshield 15mm (pair)</b>			<b>Angled TRV with Lockshield 15mm (pair)</b>			<b>Corner TRV with Lockshield 15mm (pair)</b>		
<b>Code</b>	<b>£ Ex VAT</b>	<b>£ Inc VAT</b>	<b>Code</b>	<b>£ Ex VAT</b>	<b>£ Inc VAT</b>	<b>Code</b>	<b>£ Ex VAT</b>	<b>£ Inc VAT</b>
54.0021	45.00	<b>54.00</b>	54.0018	44.00	<b>52.80</b>	54.0024	52.00	<b>62.40</b>

TRADITIONAL VALVES								
 <p><b>Comes with dark wood effect head</b></p> <p><b>Chrome</b></p>			 <p><b>Comes with dark wood effect head</b></p> <p><b>Satin Nickel</b></p>			 <p><b>Chrome</b></p>		
<b>Angled TRV with Lockshield 15mm (pair)</b>			<b>Angled TRV with Lockshield 15mm (pair)</b>					
<b>Code</b>	<b>£ Ex VAT</b>	<b>£ Inc VAT</b>	<b>Code</b>	<b>£ Ex VAT</b>	<b>£ Inc VAT</b>	<b>Code</b>	<b>£ Ex VAT</b>	<b>£ Inc VAT</b>
54.0008	90.00	<b>108.00</b>	54.0009	97.00	<b>116.40</b>	54.0001	54.00	<b>64.80</b>
 <p><b>Comes with dark wood effect head</b></p> <p><b>Chrome</b></p>			 <p><b>Comes with dark wood effect head</b></p> <p><b>Satin Nickel</b></p>			<b>MANUAL VALVE</b>		
<b>Corner TRV with Lockshield 15mm (pair)</b>			<b>Corner TRV with Lockshield 15mm (pair)</b>			<b>Angled Traditional Valves with Tails (pair)</b>		
<b>Code</b>	<b>£ Ex VAT</b>	<b>£ Inc VAT</b>	<b>Code</b>	<b>£ Ex VAT</b>	<b>£ Inc VAT</b>	<b>Code</b>	<b>£ Ex VAT</b>	<b>£ Inc VAT</b>
54.0010	113.00	<b>135.60</b>	54.0011	116.00	<b>139.20</b>	54.0001	54.00	<b>64.80</b>

- FEATURES**
- Approved to EN 1074-2:2000
  - All valves are 15mm models
  - Produced to GB/T 19001-2016 and ISO 9001:2015
  - Not bi-directional, TRV head must be fitted to flow side.
  - 2 Year warranty\*
  - \*With conditions

TWIN THERMOSTATIC VALVES						FEATURES		
54.0012	54.0013	54.0014	54.0015			<ul style="list-style-type: none"> <li>• All twin thermostatic valves are 15mm</li> <li>• Tapping Centres: 50mm</li> <li>• Approved to EN 1074-2:2000</li> <li>• Produced to GB/T 19001-2016 and ISO 9001:2015</li> <li>• 2 Year warranty*</li> <li>*With conditions</li> </ul>		
<b>Twin Thermostatic Valves</b>		<b>Description</b>	<b>Colour</b>	<b>Code</b>	<b>£ Ex VAT</b>			<b>£ Inc VAT</b>
		Straight Twin inlet Thermostatic Radiator Valve 15mm	Gloss White	54.0012	74.00			<b>88.80</b>
		Straight Twin inlet Thermostatic Radiator Valve 15mm	Chrome	54.0013	68.00			<b>81.60</b>
		Angled Twin inlet Thermostatic Radiator Valve 15mm	Gloss White	54.0014	74.00			<b>88.80</b>
		Angled Twin inlet Thermostatic Radiator Valve 15mm	Chrome	54.0015	68.00			<b>81.60</b>

# Thermostatic & Manual Valves

## STRAIGHT TRV



BI-DIRECTIONAL

Chrome/White

**Straight TRV with Lockshield 15mm (pair)**

Code	£ Ex VAT	£ Inc VAT
41.3038	19.00	22.80

While Stocks Last.  
Gloss White & Hard Chrome finish.

## ANGLED TRV



BI-DIRECTIONAL

Chrome/White

**Angled TRV with Lockshield 15mm (pair)**

Code	£ Ex VAT	£ Inc VAT
41.3039	19.00	22.80

While Stocks Last.  
Gloss White & Hard Chrome finish.

## CORNER TRV



BI-DIRECTIONAL

Chrome/White

**Corner TRV with Lockshield 15mm (pair)**

Code	£ Ex VAT	£ Inc VAT
41.3040	27.00	32.40

While Stocks Last.  
Gloss White & Chrome finish.

## Straight Valves



**Square Straight Radiator Valves - Chrome (pair)**

Code	£ Ex VAT	£ Inc VAT
41.3002	73.00	87.60



**Minimalist Straight Radiator Valves - Chrome (pair)**

Code	£ Ex VAT	£ Inc VAT
41.3005	45.00	54.00



**Square Straight Radiator Valves - Chrome (pair)**

Code	£ Ex VAT	£ Inc VAT
12.038	97.00	116.40



**Straight Radiator Valves - Matt White (pair)**

Code	£ Ex VAT	£ Inc VAT
41.3013	46.00	55.20



**Straight Radiator Valves - Chrome (pair)**

Code	£ Ex VAT	£ Inc VAT
41.3008	46.00	55.20



**Straight Radiator Valves - Matt Anthracite (pair)**

Code	£ Ex VAT	£ Inc VAT
41.3016	45.00	54.00



**Straight Radiator Valves - Matt Black (pair)**

Code	£ Ex VAT	£ Inc VAT
41.3014	46.00	55.20



**NEW**

**Due in November 2023**

**Straight Radiator Valves - Brushed Brass (pair)**

Code	£ Ex VAT	£ Inc VAT
41.0609	49.00	58.80

# Manual Valves

## Angled Valves



Square Angled Radiator Valves - Chrome (pair)		
Code	£ Ex VAT	£ Inc VAT
41.3001	70.00	84.00



Minimalist Angled Radiator Valves - Chrome (pair)		
Code	£ Ex VAT	£ Inc VAT
41.3004	44.00	52.80



Angled Square Radiator Valves - Chrome (pair)		
Code	£ Ex VAT	£ Inc VAT
12.036	107.00	128.40



Angled Radiator Valves - Chrome (pair)		
Code	£ Ex VAT	£ Inc VAT
41.3007	47.00	56.40



Angled Radiator Valves - Matt White (pair)		
Code	£ Ex VAT	£ Inc VAT
41.3011	45.00	54.00



Angled Radiator Valves - Matt Anthracite (pair)		
Code	£ Ex VAT	£ Inc VAT
41.3015	46.00	55.20



Angled Radiator Valves - Matt Black (pair)		
Code	£ Ex VAT	£ Inc VAT
41.3012	45.00	54.00



Angled Radiator Valves - Brushed Brass (pair)		
Code	£ Ex VAT	£ Inc VAT
41.0610	51.00	61.20

**NEW**

Due in November 2023

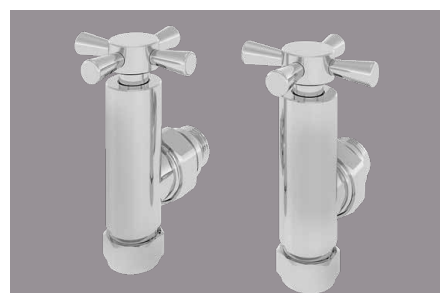

Angled Crosshead Radiator Valves - Chrome (pair)		
Code	£ Ex VAT	£ Inc VAT
54.0025	46.00	55.20

## Corner Valves



Square Corner Radiator Valves - Chrome (pair)		
Code	£ Ex VAT	£ Inc VAT
41.3010	90.00	108.00



Corner Radiator Valves - Chrome (pair)		
Code	£ Ex VAT	£ Inc VAT
41.3006	50.00	60.00



Corner Radiator Valves - Matt White (pair)		
Code	£ Ex VAT	£ Inc VAT
41.3017	52.00	62.40

# Manual Valves

## Corner Valves (continued)



Corner Radiator Valves - Matt Anthracite (pair)

Code	£ Ex VAT	£ Inc VAT
41.3018	52.00	62.40



Corner Radiator Valves - Matt Black (pair)

Code	£ Ex VAT	£ Inc VAT
41.3019	52.00	62.40



NEW

Due in November 2023

Corner Radiator Valves - Brushed Brass (pair)

Code	£ Ex VAT	£ Inc VAT
41.0611	54.00	64.80

## Traditional Valves



Pair of Radiator Valves + Tails Chrome

Code	£ Ex VAT	£ Inc VAT
41.3009	79.00	94.80



NEW

Due in November 2023

Pair of Radiator Valves + Tails Gloss White

Code	£ Ex VAT	£ Inc VAT
41.0729	77.00	92.40



NEW

Due in November 2023

Pair of Radiator Valves + Tails Matt Anthracite

Code	£ Ex VAT	£ Inc VAT
41.0730	77.00	92.40



NEW

Due in November 2023

Pair of Radiator Valves + Tails Matt Black

Code	£ Ex VAT	£ Inc VAT
41.0731	77.00	92.40



NEW

Due in November 2023

Pair of Radiator Valves + Tails Brushed Brass

Code	£ Ex VAT	£ Inc VAT
41.0710	89.00	106.80

### TRADITIONAL VALVE SHROUDS FEATURES

- Material : High Quality Brass
- Shroud length : 150mm, can be cut to desired length

### Drain Off Valve

Drain Off Valve				
Description	Colour	Code	£ Ex VAT	£ Inc VAT
15mm Lockshield with Drain Valve	Chrome	12.052	15.00	18.00

#### FEATURES

- Can be used to drain off radiators.
- Chrome plated brass body, comes with white cover cap.

12.052



# Thermostatic Valves

## Straight Thermostatic Valves

12.043



**15mm TRV & Lockshield - Chrome**

Code	£ Ex VAT	£ Inc VAT
12.043	54.00	64.80

12.048



**15mm TRV & Lockshield - Chrome/White**

Code	£ Ex VAT	£ Inc VAT
12.048	44.00	52.80

41.3020



**15mm TRV & Lockshield - Matt White**

Code	£ Ex VAT	£ Inc VAT
41.3020	50.00	60.00

41.3026\*



**15mm TRV & Lockshield - Matt Grey**

Code	£ Ex VAT	£ Inc VAT
41.3026	60.00	72.00

41.3028\*



**15mm TRV & Lockshield - Matt Cappuccino**

Code	£ Ex VAT	£ Inc VAT
41.3028	60.00	72.00

41.3021



**15mm TRV & Lockshield - Matt Anthracite**

Code	£ Ex VAT	£ Inc VAT
41.3021	50.00	60.00

## Straight Thermostatic Valves

41.3022



**15mm TRV & Lockshield - Matt Black**

Code	£ Ex VAT	£ Inc VAT
41.3022	50.00	60.00

41.3035



**15mm TRV & Lockshield - Brushed Brass**

Code	£ Ex VAT	£ Inc VAT
41.3035	69.00	82.80

## Angled Thermostatic Valves

12.041



**15mm TRV & Lockshield - Chrome**

Code	£ Ex VAT	£ Inc VAT
12.041	54.00	64.80

12.047



**15mm TRV & Lockshield - Chrome/White**

Code	£ Ex VAT	£ Inc VAT
12.047	44.00	52.80

41.3023



**15mm TRV & Lockshield - Matt White**

Code	£ Ex VAT	£ Inc VAT
41.3023	47.00	56.40

41.3027



**15mm TRV & Lockshield - Matt Grey**

Code	£ Ex VAT	£ Inc VAT
41.3027	56.00	67.20

### FEATURES (STRAIGHT & ANGLED)

- 15mm straight models
- Approved to EN215
- Produced to ISO 9001: - 2008
- Energy saving - lower fuel bills
- Controls individual radiators to allow varying comfort levels throughout the home
- Reversible tail piece facilitates vertical or horizontal installation
- Luxury gloss white/chrome, matt white, matt grey, matt cappuccino, matt black, brushed nickel, brushed brass and chrome finishes
- 2 Year warranty with conditions

All straight TRV's are BI-DIRECTIONAL

All angled TRV's are BI-DIRECTIONAL

### TECHNICAL INFORMATION

On all TRV's, due to different materials used, there can be a slight difference between the parts colours. The numbers on the TRV heads do not represent specific room temperatures as the temperature at which the valve operates depends on the water temperature flowing through the radiator, airflow around the head of the TRV, the room size and any heat loss in that space through walls, windows and floors.

# Thermostatic Valves

## Angled Thermostatic Valves

41.3029\*



**15mm TRV & Lockshield - Matt Cappuccino**

Code	£ Ex VAT	£ Inc VAT
41.3029	56.00	67.20

41.3024



**15mm TRV & Lockshield - Matt Anthracite**

Code	£ Ex VAT	£ Inc VAT
41.3024	47.00	56.40

41.3025



**15mm TRV & Lockshield - Matt Black**

Code	£ Ex VAT	£ Inc VAT
41.3025	47.00	56.40

## Angled Thermostatic Valves

41.3036



**15mm TRV & Lockshield - Brushed Brass**

Code	£ Ex VAT	£ Inc VAT
41.3036	69.00	82.80

## Corner Thermostatic Valves

12.045



**15mm TRV & Lockshield - Chrome**

Code	£ Ex VAT	£ Inc VAT
12.045	54.00	64.80

12.035



**15mm TRV & Lockshield - Nickel/White**

Code	£ Ex VAT	£ Inc VAT
12.035	46.00	55.20

12.049



**15mm TRV & Lockshield - Chrome/White**

Code	£ Ex VAT	£ Inc VAT
12.049	44.00	52.80

12.053



**15mm TRV & Lockshield - Matt White**

Code	£ Ex VAT	£ Inc VAT
12.053	76.00	91.20

12.054



**15mm TRV & Lockshield - Matt Grey**

Code	£ Ex VAT	£ Inc VAT
12.054	76.00	91.20

12.055



**15mm TRV & Lockshield - Matt Cappuccino**

Code	£ Ex VAT	£ Inc VAT
12.055	80.00	96.00

12.056



**15mm TRV & Lockshield - Matt Anthracite**

Code	£ Ex VAT	£ Inc VAT
12.056	76.00	91.20

12.057



**15mm TRV & Lockshield - Matt Black**

Code	£ Ex VAT	£ Inc VAT
12.057	76.00	91.20

41.3037



**15mm TRV & Lockshield - Brushed Brass**

Code	£ Ex VAT	£ Inc VAT
41.3037	80.00	96.00

### FEATURES (CORNER VALVES)

- 15mm corner models
- Approved to EN215
- Produced to ISO 9001: - 2008
- Energy saving - lower fuel bills
- Controls individual radiators to allow varying comfort levels throughout the home

- Reversible tail piece facilitates vertical or horizontal installation
- Luxury gloss white/chrome, matt white, matt grey, matt cappuccino, matt black, brushed nickel, brushed brass and chrome finishes
- 2 Year warranty\*

\* With conditions

### TECHNICAL INFORMATION

\*\*Due to different materials used, there can be a slight difference between the parts colours.

The Corner TRV can **only** be fitted RH if fitting on bottom connection or LH if fitting on side connection.

# Accessories

## Multi-Rail Towel Hangers

Must be fitted before installation.



Multi-Rail Hanger - Gloss White			
Size	Code	£ Ex VAT	£ Inc VAT
300mm	101.0010	46.00	55.20
400mm	101.0012	47.00	56.40
450mm	101.0016	52.00	62.40
500mm	101.0018	54.00	64.80
600mm	101.0022	60.00	72.00
750mm	101.0026	63.00	75.60

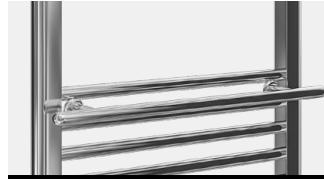

Multi-Rail Hanger - Chrome			
Size	Code	£ Ex VAT	£ Inc VAT
300mm	101.0011	62.00	74.40
400mm	101.0015	63.00	75.60
450mm	101.0017	70.00	84.00
500mm	101.0021	78.00	93.60
600mm	101.0025	83.00	99.60
750mm	101.0027	88.00	105.60



Multi-Rail Hanger - Matt Anthracite			
Size	Code	£ Ex VAT	£ Inc VAT
400mm	101.0014	47.00	56.40
500mm	101.0020	54.00	64.80
600mm	101.0024	60.00	72.00



Multi-Rail Hanger - Matt White			
Size	Code	£ Ex VAT	£ Inc VAT
400mm	101.0013	47.00	56.40
500mm	101.0019	54.00	64.80
600mm	101.0023	60.00	72.00

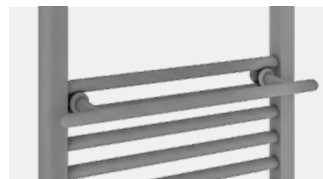

Multi-Rail Hanger - Matt Grey			
Size	Code	£ Ex VAT	£ Inc VAT
400mm	101.0111	47.00	56.40
500mm	101.0112	54.00	64.80
600mm	101.0113	60.00	72.00

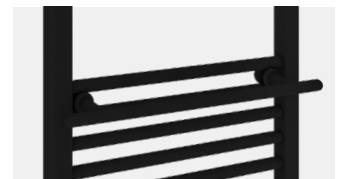

Multi-Rail Hanger - Matt Black			
Size	Code	£ Ex VAT	£ Inc VAT
400mm	101.0061	47.00	56.40
500mm	101.0062	54.00	64.80
600mm	101.0063	60.00	72.00

### Compatible Radiators

Wendover Straights	All Models	Wingrave Straights	All Models	Biava Dry Elements	All Models	Westwards	All Models
Biava Tube on Tube	All Models	Biava Multi-Rail	All Models	Biava Multirail Hidden Vent	All Models		

## Rivassa & Imperia - Towel Hangers

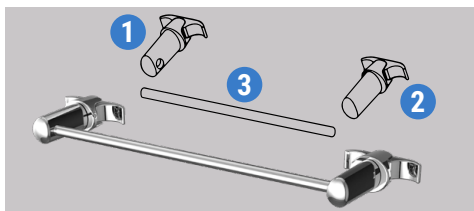

Towel hanger comes in three unassembled pieces. Please cut 600mm bar to required column-to-column length.

Rivassa Towel Hanger				
Size	Colour	Code	£ Ex VAT	£ Inc VAT
600mm	Chrome	16.158	121.00	145.20
600mm	White	16.157	84.00	100.80

Can be fitted after installation!

## Rivassa & Imperia - Robe Hooks

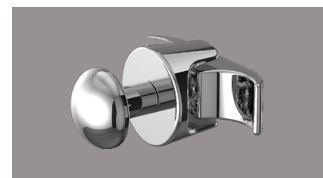

Robe Hook - Chrome			
Details	Code	£ Ex VAT	£ Inc VAT
Single Hook	16.006	20.00	24.00

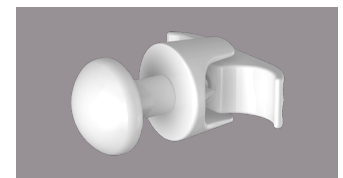

Robe Hook - White			
Details	Code	£ Ex VAT	£ Inc VAT
Single Hook	16.005	17.00	20.40

Can be fitted after installation!

## Towel Rail - Towel Hangers

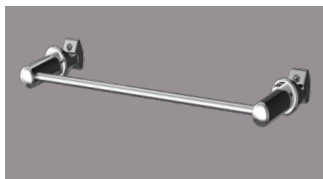

Towel Hanger - Chrome			
Size	Code	£ Ex VAT	£ Inc VAT
210mm	16.002	67.00	80.40
310mm	16.004	68.00	81.60
360mm	16.352	70.00	84.00
470mm	16.350	72.00	86.40
600mm	16.351	74.00	88.80

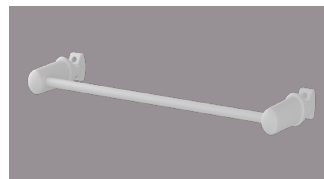

Towel Hanger - White			
Size	Code	£ Ex VAT	£ Inc VAT
210mm	16.001	50.00	60.00
310mm	16.003	53.00	63.60
360mm	16.152	56.00	67.20
470mm	16.150	60.00	72.00
600mm	16.151	62.00	74.40

Can be fitted after installation! Cannot be cut down.

## Towel Rail - Robe Hooks

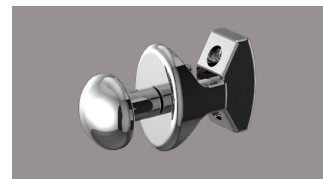

Robe Hook - Chrome			
Details	Code	£ Ex VAT	£ Inc VAT
Hook Pair	16.500	45.00	54.00



Robe Hook - White			
Details	Code	£ Ex VAT	£ Inc VAT
Hook Pair	16.600	37.00	44.40

Can be fitted after installation!



## Pipe Shrouds and Collar Kits (Slide On)

**NEW**

Due in November 2023

Pipe Shrouds and Collar Kits - Slide On			
Description	Code	£ Ex VAT	£ Inc VAT
15mm Pipe Shroud & Collar Kit Gloss White	41.0597	23.00	27.60
15mm Pipe Shroud & Collar Kit Matt White	41.0598	23.00	27.60
15mm Pipe Shroud & Collar Kit Matt Grey	41.0599	23.00	27.60
15mm Pipe Shroud & Collar Kit Matt Cappuccino	41.0600	23.00	27.60
15mm Pipe Shroud & Collar Kit Matt Anthracite	41.0601	23.00	27.60
15mm Pipe Shroud & Collar Kit Matt Black	41.0602	23.00	27.60
15mm Pipe Shroud & Collar Kit Chrome	41.0603	21.00	25.20
15mm Pipe Shroud & Collar Kit Brushed Brass	41.0604	29.00	34.80
15mm Pipe Shroud & Collar Kit Satin Nickel	41.0605	29.00	34.80

### FEATURES

- Manufactured from high quality brass
- Suitable for 15mm pipes, must be fitted together with radiator installation
- Each kit includes two pipe shrouds and two collars
- Shroud length 200mm., can be cut to desired length



## Pipe Shrouds and Collar Kits (Clip On)

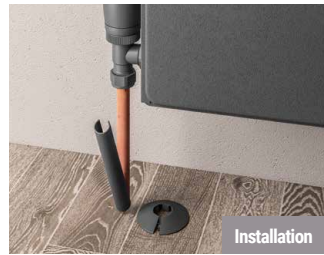

Pipe Shrouds and Collar Kits - Clip On			
Description	Code	£ Ex VAT	£ Inc VAT
15mm Pipe Shroud & Collar Kit White	92.0001	14.00	16.80
15mm Pipe Shroud & Collar Kit Chrome	92.0002	21.00	25.20
15mm Pipe Shroud & Collar Kit Anthracite	92.0003	15.00	18.00
15mm Pipe Shroud & Collar Kit Black	92.0004	15.00	18.00

### FEATURES

- Manufactured from high grade polypropylene
- Suitable for 15mm pipes, easy-fit after radiator installation
- Available in white, anthracite, black and chrome
- Each kit includes two pipe shrouds and two collars
- Shroud length 200mm., can be cut to desired length
- Easy push-fit installation



## Towel Rail Toilet Paper Holder



Toilet Paper Holder - White		
Code	£ Ex VAT	£ Inc VAT
16.155	95.00	114.00



Toilet Paper Holder - Chrome		
Code	£ Ex VAT	£ Inc VAT
16.156	103.00	123.60

### Compatible Radiators

Wendover	All Models	Wingrave	All Models
Biava Tube on Tube	All Models	Biava Multi-Rail	All Models
Biava Dry Elements	All Models	Westward	All Models

## Towel Rail Room Divider Bracket Sets

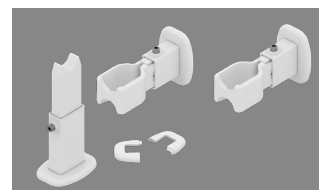

Room Divider Bracket Set - White		
Code	£ Ex VAT	£ Inc VAT
16.153	160.00	192.00

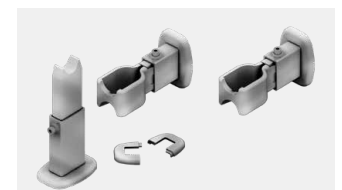

Room Divider Bracket Set - Chrome		
Code	£ Ex VAT	£ Inc VAT
16.154	225.00	270.00

### Compatible Radiators

Wendover Straight	All Colours	Wingrave Straight	All Colours
Westward	All Colours	Biava Multi-Rail Straight	All Colours
Biava Dry Element	All Colours	Corinium Round	All Colours

# Accessories

## Multi-Purpose Towel Hangers



Towel Hanger - Matt White - Left / Right			
Size	Code	£ Ex VAT	£ Inc VAT
300mm	89.0882L/89.0882R	128.00	<b>153.60</b>
400mm	89.0883L/89.0883R	131.00	<b>157.20</b>
500mm	89.0884L/89.0884R	134.00	<b>160.80</b>



Towel Hanger - Matt Grey - Left / Right			
Size	Code	£ Ex VAT	£ Inc VAT
300mm	89.0885L/89.0885R	128.00	<b>153.60</b>
400mm	89.0886L/89.0886R	131.00	<b>157.20</b>
500mm	89.0887L/89.0887R	134.00	<b>160.80</b>



Towel Hanger - Matt Cappuccino - Left / Right			
Size	Code	£ Ex VAT	£ Inc VAT
300mm	89.0888L/89.0888R	128.00	<b>153.60</b>
400mm	89.0889L/89.0889R	131.00	<b>157.20</b>
500mm	89.0890L/89.0890R	134.00	<b>160.80</b>



Towel Hanger - Matt Anthracite - Left / Right			
Size	Code	£ Ex VAT	£ Inc VAT
300mm	89.0891L/89.0891R	128.00	<b>153.60</b>
400mm	89.0892L/89.0892R	131.00	<b>157.20</b>
500mm	89.0893L/89.0893R	134.00	<b>160.80</b>



Towel Hanger - Matt Black - Left / Right			
Size	Code	£ Ex VAT	£ Inc VAT
300mm	89.0894L/89.0894R	128.00	<b>153.60</b>
400mm	89.0895L/89.0895R	131.00	<b>157.20</b>
500mm	89.0896L/89.0896R	134.00	<b>160.80</b>

### TECHNICAL INFORMATION

Please check the technical drawing to see all the required measurements. Multi-Purpose Towel Hangers can only be fitted on the wall. Only vertical radiators have been used in the compatibility chart.

Left Hand Towel Hangers : When fitted on the wall and looking from front, shelf is on the left and towel can be hung from the right.

Right Hand Towel Hangers : When fitted on the wall and looking from front, shelf is on the right and towel can be hung from the left.

**Can be fitted after installation!**

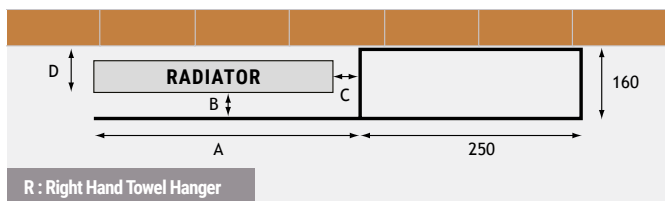
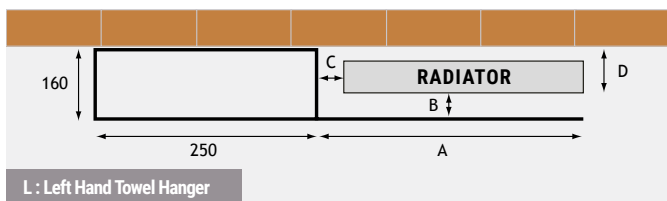

### MULTI-PURPOSE TOWEL HANGER COMPATIBILITY CHART

Radiator Model	Radiator Width (mm)				Towel Hanger length A (mm)				Shelf Width (mm)	Shelf Depth (mm)	Towel hanger to wall distance (mm)	Radiator's Front to Wall Distance D (mm)	Towel Hanging Distance B (mm)	Distance from Radiator to Towel Shelf C (mm)			
	1.)	2.)	3.)	4.)	1.)	2.)	3.)	4.)						1.)	2.)	3.)	4.)
RUBANO	383				500				250	160	160	114	46	117			
ROWSHAM	300	380			400	500			250	160	160	110	50	100	120		
TUNSTALL	280	420			400	500			250	160	160	93	67	120	80		
TUNSTALL DOUBLE	280	420			400	500			250	160	160	104	56	120	80		
ADDINGTON TYPE10	292	366	440		400	400	500		250	160	160	70	90	108	34	60	
DEDDINGTON	310	470			400	500			250	160	160	100	60	90	30		
ADDINGTON TYPE20	366	440			400	500			250	160	160	93	67	34	60		
ADDINGTON ALUMINIUM TYPE10	292	366	440		400	400	500		250	160	160	76.5	83.5	108	34	60	
ADDINGTON ALUMINIUM TYPE20	366	440			400	500			250	160	160	96.5	63.5	34	60		
ROSANO	280	375	470		300	400	500		250	160	160	70/90	90/70	20	25	30	
PERETTI	280	375	470		300	400	500		250	160	160	70/90	90/70	20	25	30	
SANDHURST	275	415	485		300	500	500		250	160	160	105	55	25	85	15	
TORDINO	280	375	470		300	400	500		250	160	160	80/100	80/60	20	25	30	
GUARDIA / Flat Side	280	375	470		300	400	500		250	160	160	100	60	20	25	30	
GUARDIA / Curved Side	280	375	470		300	400	500		250	160	160	110	50	20	25	30	
HADLEIGH	275	415	485		300	500	500		250	160	160	98	62	25	85	15	
VESIMA	303	403			400	500			250	160	160	85/105	75/55	97	97		
PRESTON	185				300				250	160	160	71/91	89/69	115			
BERLINI	185				300				250	160	160	70/90	90/70	115			
CHARLTON	280	375	470		300	400	500		250	160	160	71/91	89/69	20	25	30	
WITHINGTON	280	375	470		300	400	500		250	160	160	71/91	89/69	20	25	30	
MALMESBURY	185	280	375	470	300	300	400	500	250	160	160	79/99	81/61	115	20	25	30
FAIRFORD	375				400				250	160	160	81/101	79/59	25			
BURFORD	275	345	415	485	300	400	500	500	250	160	160	108/128	52/32	25	55	85	15
KELMSCOTT	275	345	415	485	300	400	500	500	250	160	160	83/103	77/57	25	55	85	15

## Round Vent Caps



Round Vent Caps - White			
Description	Code	£ Ex VAT	£ Inc VAT
Round Vent Cap (pair)	101.0001	17.00	20.40



Round Vent Caps - Grey			
Description	Code	£ Ex VAT	£ Inc VAT
Round Vent Cap (pair)	101.0002	17.00	20.40



Round Vent Caps - Cappuccino			
Description	Code	£ Ex VAT	£ Inc VAT
Round Vent Cap (pair)	101.0003	17.00	20.40



Round Vent Caps - Anthracite			
Description	Code	£ Ex VAT	£ Inc VAT
Round Vent Cap (pair)	101.0004	17.00	20.40



Round Vent Caps - Black			
Description	Code	£ Ex VAT	£ Inc VAT
Round Vent Cap (pair)	101.0005	17.00	20.40



Round Vent Caps - Chrome			
Description	Code	£ Ex VAT	£ Inc VAT
Round Vent Cap (pair)	101.0006	17.00	20.40

## Compatible Radiators

Wingrave	Biava Square	Marlow E-Style	Deddington Towel Rail	Fairford
Wendover	Leonardo	Rubano	Addington Type21	Burford
Tuscan	Hurley	Rowsham	Addington Type22	Kelmscott
Biava Multirail	Helmsley	Tunstall	Addington Type20 Towel Rail	Witney
Biava Multirail HV	Staverton Tube on Tube Straight	Tunstall Double	Addington Type21 Towel Rail	Rivassa 2 Column
Westward	Staverton	Tunstall Mirror	Berkeley	Rivassa 3 Column
Biava Round	Staverton Tube on Tube Curved	Addington Type10	Preston	Rivassa 4 Column
Biava Tube on Tube	Mezzo Tondo	Addington Type20	Charlton	Imperia 2 Column
Launton	Pesaro	Deddington	Withington	Imperia 3 Column
Haddenham	Marlow	Addington Type10 Towel Rail	Malmesbury	Corinium Round
Tuscan Round	Tuscan Square	Tordino	Platani	Reinbach
Murano	Lambourne	Tuscan Square Multirail	Corinium Round	Tuscan Round

## D-Shape Vent Caps



D-Shape Vent Caps - White			
Description	Code	£ Ex VAT	£ Inc VAT
D-Shape Vent Cap (pair)	101.0007	19.00	22.80



D-Shape Vent Caps - Anthracite			
Description	Code	£ Ex VAT	£ Inc VAT
D-Shape Vent Cap (pair)	101.0008	19.00	22.80



D-Shape Vent Caps - Grey			
Description	Code	£ Ex VAT	£ Inc VAT
D-Shape Vent Cap (pair)	101.0114	19.00	22.80



D-Shape Vent Caps - Chrome			
Description	Code	£ Ex VAT	£ Inc VAT
D-Shape Vent Cap (pair)	101.0009	19.00	22.80



D-Shape Vent Caps - Black			
Description	Code	£ Ex VAT	£ Inc VAT
D-Shape Vent Cap (pair)	101.0060	19.00	22.80



## Compatible Radiators

Wingrave	Westwood	Defford	Santero	Rion Multirail
----------	----------	---------	---------	----------------

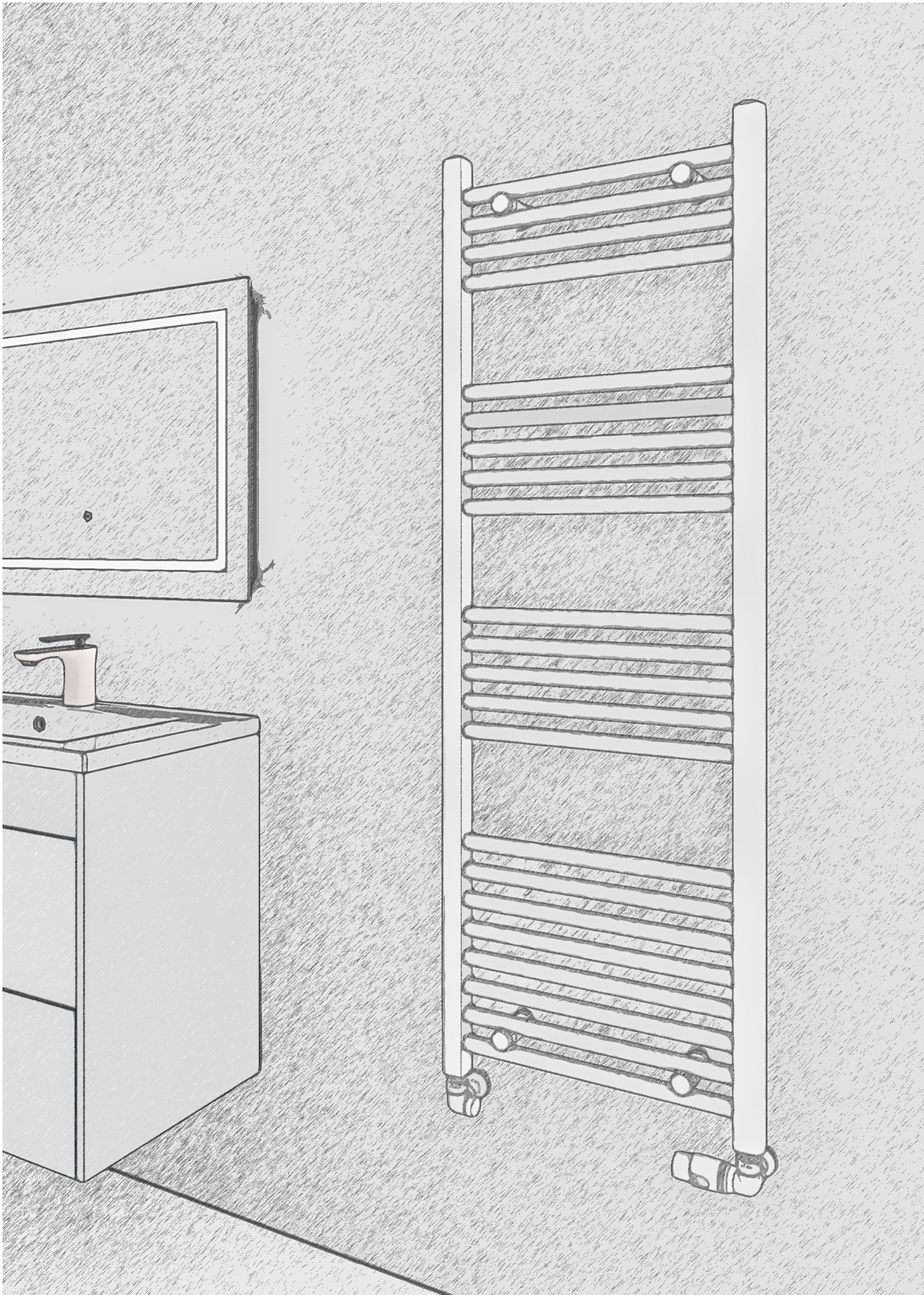

# Technical Section

In this section you'll find the technical specifications for every single model / size within the Radiator Collection brochure.

Jump quickly from the model page, to the relevant technical page by using the 'Technical Table & Drawings' boxes.

Example:

Technical Tables  
& Drawings  
Page 00-00



## Technical Section Contents

The Multirail Range	316-237
The Dry Element Range	327-329
The Stainless Steel Range	330-331
The Designer Range	332-357
The Flat Panel Range	356-359
The Aluminium Range	360-379
The Traditional Range	378-387

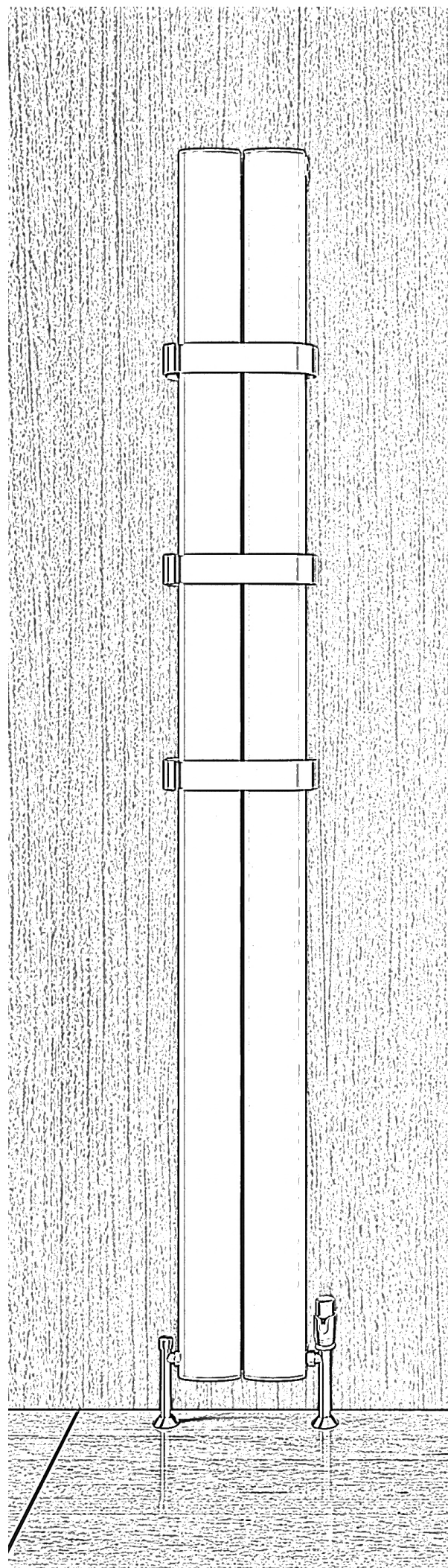

# Technical Tables & Drawings

## WENDOVER - THE MULTIRAIL RANGE

Wendover - Straight																	
Height H (mm)	Width W (mm)	Tappings C (mm)	Tappings from wall - A (mm)	Distance from wall - D (mm)	Tube Qty	Water Content L	Weight KG	Colour	▲T60		Element Output	Element Type	Colour	▲T60		Element Output	Element Type
									Watts	BTU				Watts	BTU		
360	400	350	75-95*	90-110**	7	1.38	2.41	Coloured	112	423	N/A	N/A	Chrome	112	347	N/A	N/A
600	300	250	75-95*	90-110**	10	1.81	3.08	Coloured	196	669	100W	A,A+,D,E,F,G	Chrome	155	529	100W	A,A+,D,E,F,G
600	400	350	75-95*	90-110**	10	2.13	3.55	Coloured	241	822	150W	A,A+,D,E,F,G	Chrome / Brushed Brass	190	648	100W	A,A+,D,E,F,G
600	500	450	75-95*	90-110**	10	2.45	4.01	Coloured	285	972	150W	A,A+,D,E,F,G	Chrome / Brushed Brass	225	768	100W	A,A+,D,E,F,G
600	600	550	75-95*	90-110**	10	2.77	4.48	Coloured	330	1126	150W	A,A+,D,E,F,G	Chrome / Brushed Brass	260	887	150W	A,A+,D,E,F,G
600	750	700	75-95*	90-110**	10	3.25	5.18	Coloured	397	1355	150W	A,A+,D,E,F,G	Chrome	313	1068	150W	A,A+,D,E,F,G
600	1000	950	75-95*	90-110**	10	4.05	6.35	Coloured	510	1740	300W	A,A+,D,E,F,G	Chrome	401	1368	150W	A,A+,D,E,F,G
600	1200	1150	75-95*	90-110**	10	4.69	7.28	Coloured	600	2047	300W	A,A+,D,E,F,G	Chrome	472	1610	150W	A,A+,D,E,F,G
800	300	250	75-95*	90-110**	14	2.46	4.04	Coloured	267	911	150W	A,A+,D,E,F,G	Chrome	211	720	100W	A,A+,D,E,F,G
800	400	350	75-95*	90-110**	14	2.91	4.69	Coloured	330	1126	150W	A,A+,D,E,F,G	Chrome / Brushed Brass	260	887	150W	A,A+,D,E,F,G
800	500	450	75-95*	90-110**	14	3.36	5.34	Coloured	394	1344	150W	A,A+,D,E,F,G	Chrome / Brushed Brass	309	1054	150W	A,A+,D,E,F,G
800	600	550	75-95*	90-110**	14	3.80	6.00	Coloured	457	1559	150W	A,A+,D,E,F,G	Chrome / Brushed Brass	359	1225	150W	A,A+,D,E,F,G
800	750	700	75-95*	90-110**	14	4.48	6.98	Coloured	551	1880	300W	A,A+,D,E,F,G	Chrome	433	1477	150W	A,A+,D,E,F,G
1000	300	250	75-95*	90-110**	16	2.97	4.78	Coloured	320	1092	150W	A,A+,D,E,F,G	Chrome	251	856	150W	A,A+,D,E,F,G
1000	400	350	75-95*	90-110**	16	3.48	5.53	Coloured	392	1338	150W	A,A+,D,E,F,G	Chrome / Brushed Brass	308	1051	150W	A,A+,D,E,F,G
1000	500	450	75-95*	90-110**	16	3.99	6.27	Coloured	464	1583	150W	A,A+,D,E,F,G	Chrome / Brushed Brass	364	1242	150W	A,A+,D,E,F,G
1000	600	550	75-95*	90-110**	16	4.51	7.02	Coloured	535	1825	300W	A,A+,D,E,F,G	Chrome / Brushed Brass	421	1436	150W	A,A+,D,E,F,G
1000	750	700	75-95*	90-110**	16	5.28	8.14	Coloured	643	2194	300W	A,A+,D,E,F,G	Chrome	506	1726	300W	A,A+,D,E,F,G
1200	300	250	75-95*	90-110**	20	3.62	5.73	Coloured	392	1338	150W	A,A+,D,E,F,G	Chrome	308	1051	150W	A,A+,D,E,F,G
1200	400	350	75-95*	90-110**	20	4.26	6.67	Coloured	482	1645	300W	A,A+,D,E,F,G	Chrome / Brushed Brass	379	1293	150W	A,A+,D,E,F,G
1200	500	450	75-95*	90-110**	20	4.90	7.60	Coloured	571	1948	300W	A,A+,D,E,F,G	Chrome / Brushed Brass	450	1535	150W	A,A+,D,E,F,G
1200	600	550	75-95*	90-110**	20	5.54	8.54	Coloured	661	2255	300W	A,A+,D,E,F,G	Chrome / Brushed Brass	554	1890	300W	A,A+,D,E,F,G
1200	750	700	75-95*	90-110**	20	6.50	9.94	Coloured	796	2716	450W	A,A+,D,E,F,G	Chrome	626	2136	300W	A,A+,D,E,F,G
1400	300	250	75-95*	90-110**	22	3.4	6.38	Coloured	444	1515	150W	A,A+,D,E,F,G	Chrome	351	1193	150W	A,A+,D,E,F,G
1400	400	350	75-95*	90-110**	22	4.5	7.41	Coloured	542	1849	300W	A,A+,D,E,F,G	Chrome / Brushed Brass	429	1464	150W	A,A+,D,E,F,G
1400	500	450	75-95*	90-110**	22	5.50	8.44	Coloured	642	2191	300W	A,A+,D,E,F,G	Chrome / Brushed Brass	504	1720	150W	A,A+,D,E,F,G
1400	600	550	75-95*	90-110**	22	6.20	9.46	Coloured	740	2525	300W	A,A+,D,E,F,G	Chrome / Brushed Brass	582	1986	300W	A,A+,D,E,F,G
1400	750	700	75-95*	90-110**	22	7.7	11.01	Coloured	888	3030	450W	A,A+,D,E,F,G	Chrome	701	2392	300W	A,A+,D,E, F,G
1600	300	250	75-95*	90-110**	26	4.78	7.43	Coloured	516	1761	300W	A,A+,D,E,F,G	Chrome	406	1385	150W	A,A+,D,E,F,G
1600	400	350	75-95*	90-110**	26	5.61	8.65	Coloured	632	2156	300W	A,A+,D,E,F,G	Chrome / Brushed Brass	497	1696	300W	A,A+,D,E,F,G
1600	500	450	75-95*	90-110**	26	6.44	9.86	Coloured	749	2556	450W	A,A+,D,E,F,G	Chrome / Brushed Brass	589	2010	300W	A,A+,D,E,F,G
1600	600	550	75-95*	90-110**	26	7.28	11.08	Coloured	867	2958	450W	A,A+,D,E,F,G	Chrome / Brushed Brass	681	2324	300W	A,A+,D,E,F,G
1600	750	700	75-95*	90-110**	26	8.53	12.90	Coloured	1041	3552	600W	A,A+,D,E,F,G	Chrome	819	2794	450W	A,A+,D,E,F,G
1800	300	250	75-95*	90-110**	30	5.43	8.39	Coloured	588	2006	300W	A,A+,D,E,F,G	Chrome	462	1576	150W	A,A+,D,E,F,G
1800	400	360	75-95*	90-110**	30	6.39	9.79	Coloured	723	2467	300W	A,A+,D,E,F,G	Chrome / Brushed Brass	568	1938	300W	A,A+,D,E,F,G
1800	500	450	75-95*	90-110**	30	7.35	11.19	Coloured	856	2921	450W	A,A+,D,E,F,G	Chrome / Brushed Brass	675	2303	300W	A,A+,D,E,F,G
1800	600	550	75-95*	90-110**	30	8.31	12.59	Coloured	991	3381	600W	A,A+,D,E,F,G	Chrome / Brushed Brass	780	2661	450W	A,A+,D,E,F,G
1800	750	700	75-95*	90-110**	30	9.75	14.69	Coloured	1193	4071	600W	A,A+,D,E,F,G	Chrome	940	3207	450W	A,A+,D,E,F,G

For Brushed Brass sizes ; \*Tappings from Wall A is 59-69 mm. \*\*Distance from Wall D is 74-84 mm.

# Technical Tables & Drawings

## WENDOVER - STRAIGHT

## WENDOVER - CURVED

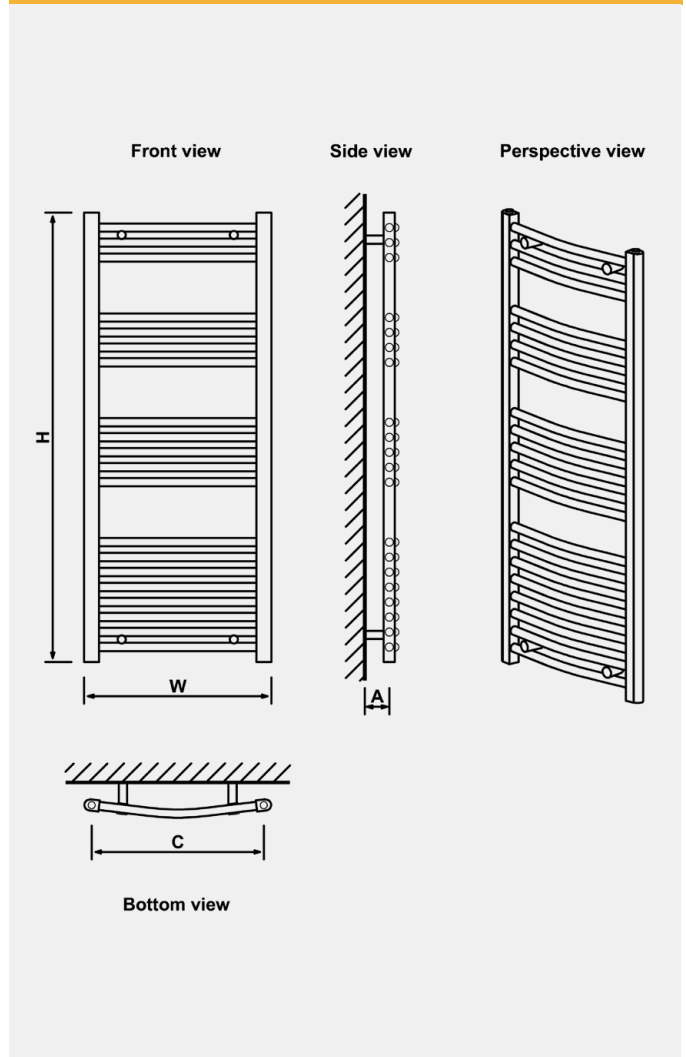
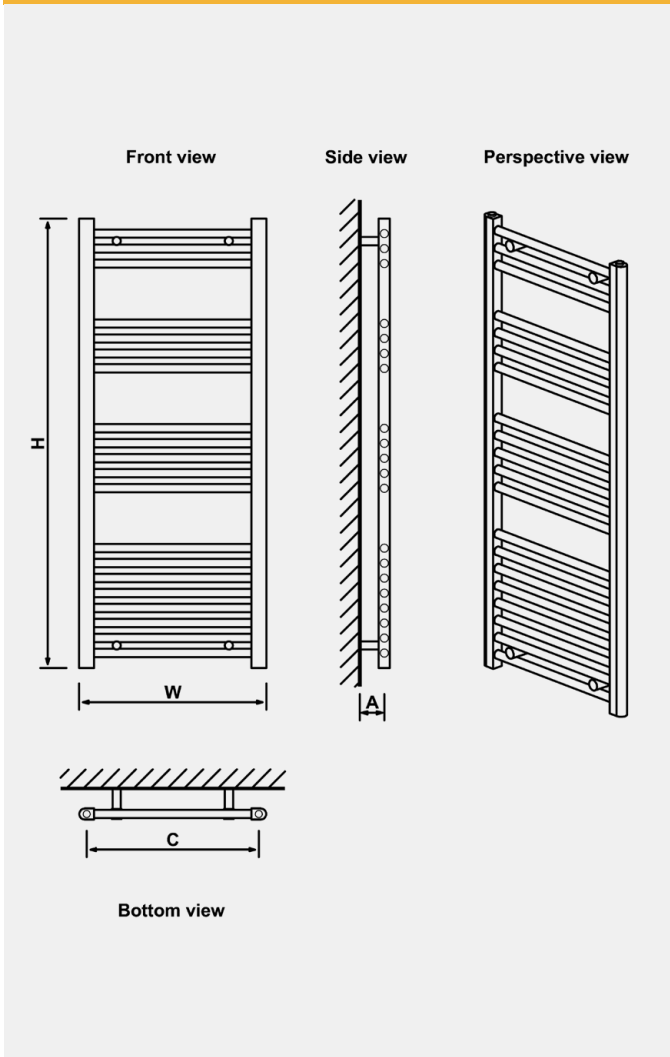

Wendoover - Curved																	
Height H (mm)	Width W (mm)	Tappings C (mm)	Tappings from wall - A (mm)	Distance from wall - D (mm)	Tube Qty	Water Content L	Weight KG	Colour	▲T60		Element Output	Element Type	Colour	▲T60		Element Output	Element Type
									Watts	BTU				Watts	BTU		
600	400	350	60-75	87-102	10	2.13	3.55	Coloured	241	822	150W	A,A+,D,E,F,G	Chrome	190	648	100W	A,A+,D,E,F,G
600	500	450	55-70	94-109	10	2.45	4.01	Coloured	285	972	150W	A,A+,D,E,F,G	Chrome	225	768	100W	A,A+,D,E,F,G
600	600	550	50-65	98-113	10	2.77	4.48	Coloured	330	1126	150W	A,A+,D,E,F,G	Chrome	260	887	150W	A,A+,D,E,F,G
600	750	700	70-90	194-214	10	3.35	5.31	Coloured	397	1355	150W	A,A+,D,E,F,G	Chrome	313	1068	150W	A,A+,D,E,F,G
800	400	350	60-75	87-102	14	2.93	4.72	Coloured	333	1136	150W	A,A+,D,E,F,G	Chrome	263	897	150W	A,A+,D,E,F,G
800	500	450	55-70	94-109	14	3.37	5.37	Coloured	396	1351	150W	A,A+,D,E,F,G	Chrome	312	1065	150W	A,A+,D,E,F,G
800	600	550	50-65	98-113	14	3.82	6.02	Coloured	459	1566	150W	A,A+,D,E,F,G	Chrome	361	1232	150W	A,A+,D,E,F,G
800	750	700	70-90	194-214	14	4.62	7.16	Coloured	551	1880	300W	A,A+,D,E,F,G	Chrome	433	1477	150W	A,A+,D,E,F,G
1000	400	350	60-75	87-102	16	3.50	5.56	Coloured	395	1348	150W	A,A+,D,E,F,G	Chrome	310	1058	150W	A,A+,D,E,F,G
1000	500	450	55-70	94-109	16	4.01	6.30	Coloured	467	1593	150W	A,A+,D,E,F,G	Chrome	367	1252	150W	A,A+,D,E,F,G
1000	600	550	50-65	98-113	16	4.53	7.05	Coloured	539	1839	300W	A,A+,D,E,F,G	Chrome	423	1443	150W	A,A+,D,E,F,G
1000	750	700	70-90	194-214	16	5.44	8.35	Coloured	643	2194	300W	A,A+,D,E,F,G	Chrome	506	1726	300W	A,A+,D,E,F,G
1200	400	350	60-75	87-102	20	4.28	6.71	Coloured	486	1658	300W	A,A+,D,E,F,G	Chrome	382	1303	150W	A,A+,D,E,F,G
1200	500	450	55-70	94-109	20	4.93	7.64	Coloured	575	1962	300W	A,A+,D,E,F,G	Chrome	452	1542	150W	A,A+,D,E,F,G
1200	600	550	50-65	98-113	20	5.57	8.57	Coloured	665	2269	300W	A,A+,D,E,F,G	Chrome	523	1784	300W	A,A+,D,E,F,G
1200	750	700	70-90	194-214	20	6.71	10.20	Coloured	796	2716	450W	A,A+,D,E,F,G	Chrome	626	2136	300W	A,A+,D,E,F,G
1600	400	350	60-75	87-102	26	5.64	8.70	Coloured	637	2173	300W	A,A+,D,E,F,G	Chrome	501	1709	300W	A,A+,D,E,F,G
1600	500	450	55-70	94-109	26	6.48	9.91	Coloured	754	2573	450W	A,A+,D,E,F,G	Chrome	593	2023	300W	A,A+,D,E,F,G
1600	600	550	50-65	98-113	26	7.31	11.12	Coloured	870	2968	450W	A,A+,D,E,F,G	Chrome	685	2337	300W	A,A+,D,E,F,G
1600	750	700	70-90	194-214	26	8.79	13.24	Coloured	1041	3552	600W	A,A+,D,E,F,G	Chrome	819	2794	450W	A,A+,D,E,F,G
1800	400	350	60-75	87-102	30	6.43	9.85	Coloured	728	2484	300W	A,A+,D,E,F,G	Chrome	573	1955	300W	A,A+,D,E,F,G
1800	500	450	55-70	94-109	30	7.39	11.25	Coloured	863	2945	450W	A,A+,D,E,F,G	Chrome	678	2313	300W	A,A+,D,E,F,G
1800	600	550	50-65	98-113	30	8.35	12.65	Coloured	998	3405	600W	A,A+,D,E,F,G	Chrome	784	2675	450W	A,A+,D,E,F,G
1800	750	700	70-90	194-214	30	10.06	15.09	Coloured	1193	4071	600W	A,A+,D,E,F,G	Chrome	940	3207	450W	A,A+,D,E,F,G

# Technical Tables & Drawings

## WINGRAVE - THE MULTIRAIL RANGE

Wingrave - Straight																	
Height H (mm)	Width W (mm)	Tappings C (mm)	Distance from wall - D (mm)	Tappings from wall - A (mm)	Tube Qty	Water Content L	Weight KG	Colour	▲T60		Element Output	Element Type	Colour	▲T60		Element Output	Element Type
									Watts	BTU				Watts	BTU		
600	300	256	79	64	10	2.10	2.90	Coloured	204	697	100W	A,A+,D,E,F,G	Chrome	131	447	100W	A,A+,D,E,F,G
600	400	356	79	64	10	2.40	3.32	Coloured	257	877	150W	A,A+,D,E,F,G	Chrome	167	570	100W	A,A+,D,E,F,G
600	500	456	79	64	10	2.70	3.87	Coloured	309	1055	150W	A,A+,D,E,F,G	Chrome	200	683	100W	A,A+,D,E,F,G
600	600	556	79	64	10	3.10	3.91	Coloured	358	1222	150W	A,A+,D,E,F,G	Chrome	233	795	150W	A,A+,D,E,F,G
600	1000	955	79	64	10	4.40	5.20	Coloured	543	1853	300W	A,A+,D,E,F,G	Chrome	355	1212	150W	A,A+,D,E,F,G
600	1200	955	79	64	10	5.00	7.30	Coloured	629	2147	300W	A,A+,D,E,F,G	Chrome	413	1410	150W	A,A+,D,E,F,G
800	300	256	79	64	14	2.80	3.55	Coloured	266	908	150W	A,A+,D,E,F,G	Chrome	171	584	100W	A,A+,D,E,F,G
800	400	356	79	64	14	2.94	4.90	Coloured	337	1150	150W	A,A+,D,E,F,G	Chrome	217	741	150W	A,A+,D,E,F,G
800	500	456	79	64	14	3.39	5.70	Coloured	404	1379	150W	A,A+,D,E,F,G	Chrome	261	891	150W	A,A+,D,E,F,G
800	600	556	79	64	14	3.85	6.50	Coloured	468	1597	300W	A,A+,D,E,F,G	Chrome	303	1034	150W	A,A+,D,E,F,G
1000	300	256	79	64	16	3.40	4.20	Coloured	331	1130	150W	A,A+,D,E,F,G	Chrome	212	724	150W	A,A+,D,E,F,G
1000	400	356	79	64	16	3.51	5.90	Coloured	419	1430	150W	A,A+,D,E,F,G	Chrome	269	918	150W	A,A+,D,E,F,G
1000	500	456	79	64	16	4.04	6.80	Coloured	502	1713	300W	A,A+,D,E,F,G	Chrome	324	1106	150W	A,A+,D,E,F,G
1000	600	556	79	64	16	4.56	7.70	Coloured	582	1986	300W	A,A+,D,E,F,G	Chrome	376	1283	150W	A,A+,D,E,F,G
1200	300	256	79	64	20	4.20	5.10	Coloured	398	1358	150W	A,A+,D,E,F,G	Chrome	256	874	150W	A,A+,D,E,F,G
1200	400	356	79	64	20	4.30	7.20	Coloured	503	1717	300W	A,A+,D,E,F,G	Chrome	324	1106	150W	A,A+,D,E,F,G
1200	500	456	79	64	20	4.95	8.30	Coloured	604	2061	300W	A,A+,D,E,F,G	Chrome	390	1331	300W	A,A+,D,E,F,G
1200	600	556	79	64	20	5.61	9.40	Coloured	700	2389	300W	A,A+,D,E,F,G	Chrome	454	1550	300W	A,A+,D,E,F,G
1400	300	256	79	64	22	4.70	5.60	Coloured	468	1597	150W	A,A+,D,E,F,G	Chrome	302	1031	150W	A,A+,D,E,F,G
1400	400	356	79	64	22	4.88	8.40	Coloured	592	2020	300W	A,A+,D,E,F,G	Chrome	383	1307	150W	A,A+,D,E,F,G
1400	500	456	79	64	22	5.60	9.40	Coloured	710	2423	300W	A,A+,D,E,F,G	Chrome	461	1573	300W	A,A+,D,E,F,G
1400	600	556	79	64	22	6.30	10.40	Coloured	824	2812	300W	A,A+,D,E,F,G	Chrome	536	1829	300W	A,A+,D,E,F,G
1600	300	256	79	64	26	5.50	6.30	Coloured	542	1850	300W	A,A+,D,E,F,G	Chrome	352	1202	150W	A,A+,D,E,F,G
1600	400	356	79	64	26	5.66	9.50	Coloured	685	2338	300W	A,A+,D,E,F,G	Chrome	446	1522	300W	A,A+,D,E,F,G
1600	500	456	79	64	26	6.51	10.80	Coloured	821	2802	300W	A,A+,D,E,F,G	Chrome	537	1833	300W	A,A+,D,E,F,G
1600	600	556	79	64	26	7.36	12.20	Coloured	953	3252	600W	A,A+,D,E,F,G	Chrome	624	2130	300W	A,A+,D,E,F,G
1800	300	256	79	64	30	6.30	7.30	Coloured	619	2113	300W	A,A+,D,E,F,G	Chrome	405	1382	150W	A,A+,D,E,F,G
1800	400	356	79	64	30	6.45	10.80	Coloured	782	2669	300W	A,A+,D,E,F,G	Chrome	514	1754	300W	A,A+,D,E,F,G
1800	500	456	79	64	30	7.43	12.20	Coloured	938	3201	600W	A,A+,D,E,F,G	Chrome	618	2109	300W	A,A+,D,E,F,G
1800	600	556	79	64	30	8.41	13.80	Coloured	1088	3713	600W	A,A+,D,E,F,G	Chrome	719	2454	300W	A,A+,D,E,F,G

Wingrave - Curved																	
Height H (mm)	Width W (mm)	Tappings C (mm)	Distance from wall - D (mm)	Tappings from wall - A (mm)	Tube Qty	Water Content L	Weight KG	Colour	▲T60		Element Output	Element Type	Colour	▲T60		Element Output	Element Type
									Watts	BTU				Watts	BTU		
800	400	356	92	65	14	3.00	4.9	Coloured	337	337	150W	A,A+,D,E,F,G	Chrome	217	741	150W	A,A+,D,E,F,G
800	500	456	92	65	14	3.58	5.9	Coloured	404	404	150W	A,A+,D,E,F,G	Chrome	261	891	150W	A,A+,D,E,F,G
800	600	556	92	65	14	4.39	7.2	Coloured	468	468	300W	A,A+,D,E,F,G	Chrome	303	1034	150W	A,A+,D,E,F,G
1000	400	356	92	65	16	5.77	9.5	Coloured	419	1430	150W	A,A+,D,E,F,G	Chrome	269	918	150W	A,A+,D,E,F,G
1000	500	456	92	65	16	6.58	10.8	Coloured	502	1713	300W	A,A+,D,E,F,G	Chrome	324	1106	150W	A,A+,D,E,F,G
1000	600	556	92	65	16	3.46	5.7	Coloured	582	1986	300W	A,A+,D,E,F,G	Chrome	376	1283	150W	A,A+,D,E,F,G
1200	400	356	92	65	20	4.12	6.8	Coloured	503	1717	300W	A,A+,D,E,F,G	Chrome	324	1106	150W	A,A+,D,E,F,G
1200	500	456	92	65	20	5.05	8.3	Coloured	604	2061	300W	A,A+,D,E,F,G	Chrome	390	1331	150W	A,A+,D,E,F,G
1200	600	556	92	65	20	6.64	10.8	Coloured	700	2389	300W	A,A+,D,E,F,G	Chrome	454	1550	300W	A,A+,D,E,F,G
1600	400	356	92	65	26	7.58	12.2	Coloured	685	2338	300W	A,A+,D,E,F,G	Chrome	446	1522	150W	A,A+,D,E,F,G
1600	500	456	92	65	26	3.93	6.5	Coloured	821	2802	450W	A,A+,D,E,F,G	Chrome	537	1833	300W	A,A+,D,E,F,G
1600	600	556	92	65	26	4.65	7.7	Coloured	953	3252	450W	A,A+,D,E,F,G	Chrome	624	2130	300W	A,A+,D,E,F,G
1800	400	356	92	65	30	5.72	9.4	Coloured	782	2669	300W	A,A+,D,E,F,G	Chrome	514	1754	300W	A,A+,D,E,F,G
1800	500	456	92	65	30	7.51	12.2	Coloured	938	3201	450W	A,A+,D,E,F,G	Chrome	618	2109	300W	A,A+,D,E,F,G
1800	600	556	92	65	30	8.58	13.8	Coloured	1088	3713	450W	A,A+,D,E,F,G	Chrome	719	2454	450W	A,A+,D,E,F,G



# Technical Tables & Drawings

## WINGRAVE - STRAIGHT

## WINGRAVE - CURVED

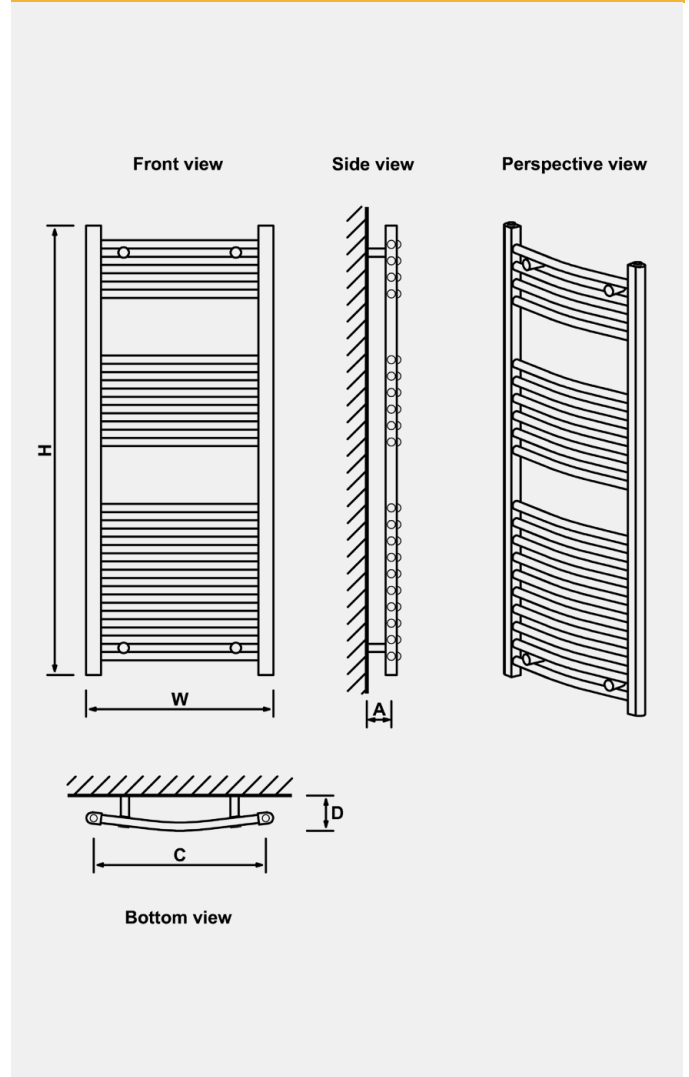
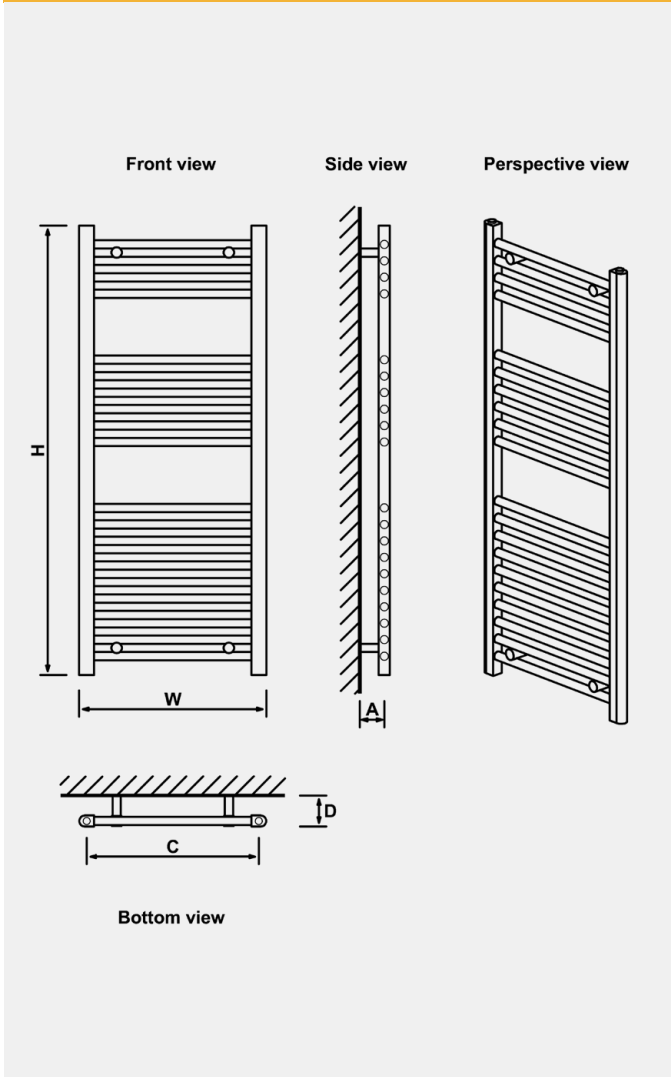

Wingrave  
Straight



Wingrave  
Curved

# Technical Tables & Drawings

## TUSCAN - THE MULTIRAIL RANGE

Tuscan																		
Height H (mm)	Width W (mm)	Tappings C (mm)	Tappings from wall - A (mm)	Distance from wall - D (mm)	Tube Qty	Water Content L	Weight KG	Colour	▲T60		Element Output	Element Type	Colour	▲T60		Element Output	Element Type	
									Watts	BTU				Watts	BTU			
650	450	400	65-80	80-95	5	1.78	3.26	Coloured	180	614	100W	A,A+,D,E,F,G	Chrome	142	485	100W	A,A+,D,E,F,G	
650	600	550	65-80	80-95	5	2.01	3.57	Coloured	212	723	100W	A,A+,D,E,F,G	Chrome	166	566	100W	A,A+,D,E,F,G	
1200	450	400	65-80	80-95	8	3.14	5.19	Coloured	315	1075	150W	A,A+,D,E,F,G	Chrome	247	843	150W	A,A+,D,E,F,G	
1200	600	550	65-80	80-95	8	3.51	5.69	Coloured	365	1245	150W	A,A+,D,E,F,G	Chrome	286	976	150W	A,A+,D,E,F,G	
1750	450	400	65-80	80-95	12	4.61	7.28	Coloured	464	1583	150W	A,A+,D,E,F,G	Chrome	366	1249	150W	A,A+,D,E,F,G	
1750	600	550	65-80	80-95	12	5.18	8.04	Coloured	537	1832	300W	A,A+,D,E,F,G	Chrome	423	1443	150W	A,A+,D,E,F,G	

## BIAVA - THE MULTIRAIL RANGE

Biava Multirail - Straight																		
Height H (mm)	Width W (mm)	Tappings C (mm)	Tappings from wall - A (mm)	Distance from wall - D (mm)	Tube Qty	Water Content L	Weight KG	Colour	▲T60		Element Output	Element Type	Colour	▲T60		Element Output	Element Type	
									Watts	BTU				Watts	BTU			
360	400	350	75-90	90-105	6	1.28	2.32	Coloured	145	495	100W	A,A+,D,E,F,G	Chrome	113	386	N/A	N/A	
688	450	400	75-90	90-105	14	2.93	4.74	Coloured	344	1174	150W	A,A+,D,E,F,G	Chrome	270	921	150W	A,A+,D,E,F,G	
688	600	550	75-90	90-105	14	3.60	5.72	Coloured	438	1494	150W	A,A+,D,E,F,G	Chrome	344	1174	150W	A,A+,D,E,F,G	
688	750	700	75-90	90-105	14	4.27	6.70	Coloured	532	1815	300W	A,A+,D,E,F,G	Chrome	418	1426	150W	A,A+,D,E,F,G	
1118	450	400	75-90	80-100	22	4.67	7.29	Coloured	546	1863	300W	A,A+,D,E,F,G	Chrome	430	1467	150W	A,A+,D,E,F,G	
1118	600	550	75-90	80-100	22	5.72	8.83	Coloured	695	2371	300W	A,A+,D,E,F,G	Chrome	546	1863	300W	A,A+,D,E,F,G	
1118	750	700	75-90	80-100	22	6.78	10.37	Coloured	843	2876	450W	A,A+,D,E,F,G	Chrome	663	2262	300W	A,A+,D,E,F,G	
1720	450	400	75-90	80-100	34	7.20	10.99	Coloured	843	2876	450W	A,A+,D,E,F,G	Chrome	663	2262	300W	A,A+,D,E,F,G	
1720	600	550	75-90	80-100	34	8.83	13.37	Coloured	1072	3658	600W	A,A+,D,E,F,G	Chrome	843	2876	450W	A,A+,D,E,F,G	
1720	750	700	75-90	80-100	34	10.46	15.76	Coloured	1302	4442	750W	A,A+,D,E,F,G	Chrome	1024	3494	600W	A,A+,D,E,F,G	

Biava Multirail - Curved																		
Height H (mm)	Width W (mm)	Tappings C (mm)	Tappings from wall - A (mm)	Distance from wall - D (mm)	Tube Qty	Water Content L	Weight KG	Colour	▲T60		Element Output	Element Type	Colour	▲T60		Element Output	Element Type	
									Watts	BTU				Watts	BTU			
360	400	350	60-75	87-102	6	1.29	2.33	Coloured	145	495	100W	A,A+,D,E,F,G	Chrome	114	389	N/A	N/A	
688	450	400	57-72	90-105	14	2.94	4.76	Coloured	347	1184	150W	A,A+,D,E,F,G	Chrome	273	931	150W	A,A+,D,E,F,G	
688	600	550	50-65	98-113	14	3.62	5.74	Coloured	440	1501	150W	A,A+,D,E,F,G	Chrome	347	1184	150W	A,A+,D,E,F,G	
688	750	700	75-90	194-214	14	4.42	6.86	Coloured	535	1825	300W	A,A+,D,E,F,G	Chrome	421	1436	150W	A,A+,D,E,F,G	
1118	450	400	57-72	96-111	22	4.69	7.33	Coloured	550	1877	300W	A,A+,D,E,F,G	Chrome	433	1477	150W	A,A+,D,E,F,G	
1118	600	550	50-65	104-119	22	5.75	8.87	Coloured	699	2385	300W	A,A+,D,E,F,G	Chrome	549	1873	300W	A,A+,D,E,F,G	
1118	750	700	75-90	194-214	22	7.01	10.63	Coloured	846	2887	450W	A,A+,D,E,F,G	Chrome	666	2272	300W	A,A+,D,E,F,G	
1720	450	400	57-72	96-111	34	7.24	11.06	Coloured	849	2897	450W	A,A+,D,E,F,G	Chrome	668	2279	300W	A,A+,D,E,F,G	
1720	600	550	50-65	104-119	34	8.87	13.44	Coloured	1078	3678	600W	A,A+,D,E,F,G	Chrome	848	2893	450W	A,A+,D,E,F,G	
1720	750	700	75-90	194-214	34	10.81	16.18	Coloured	1307	4459	750W	A,A+,D,E,F,G	Chrome	1029	3511	600W	A,A+,D,E,F,G	

Biava Multirail Hidden Vent (HV) - Straight																		
Height H (mm)	Width W (mm)	Tappings C (mm)	Tappings from wall - A (mm)	Tube Qty	Water Content L	Weight KG	Colour	▲T60		Element Output	Element Type	Colour	▲T60		Element Output	Element Type		
								Watts	BTU				Watts	BTU				
360	400	350	70-85	6	1.40	2.20	Coloured	145	495	100W	A,A+,D,E,F,G	Chrome	113	386	N/A	N/A		
688	450	400	70-85	14	3.10	4.90	Coloured	344	1174	150W	A,A+,D,E,F,G	Chrome	270	921	150W	A,A+,D,E,F,G		
688	600	550	70-85	14	3.70	5.90	Coloured	438	1494	150W	A,A+,D,E,F,G	Chrome	344	1174	150W	A,A+,D,E,F,G		
688	750	700	70-85	14	4.40	7.00	Coloured	532	1815	300W	A,A+,D,E,F,G	Chrome	418	1426	150W	A,A+,D,E,F,G		
1118	450	400	70-85	22	4.88	7.70	Coloured	546	1863	300W	A,A+,D,E,F,G	Chrome	430	1467	150W	A,A+,D,E,F,G		
1118	600	550	70-85	22	5.94	9.40	Coloured	695	2371	300W	A,A+,D,E,F,G	Chrome	546	1863	300W	A,A+,D,E,F,G		
1118	750	700	70-85	22	7.00	11.00	Coloured	843	2876	450W	A,A+,D,E,F,G	Chrome	663	2262	300W	A,A+,D,E,F,G		
1720	450	400	70-85	34	7.53	11.90	Coloured	843	2876	450W	A,A+,D,E,F,G	Chrome	663	2262	300W	A,A+,D,E,F,G		
1720	600	550	70-85	34	9.17	14.40	Coloured	1072	3658	600W	A,A+,D,E,F,G	Chrome	843	2876	450W	A,A+,D,E,F,G		
1720	750	700	70-85	34	10.80	17.00	Coloured	1302	4442	750W	A,A+,D,E,F,G	Chrome	1024	3494	600W	A,A+,D,E,F,G		



Tuscan



Biava Multirail  
Straight



Biava Multirail  
Curved



Biava Multirail HV  
Straight

# Technical Tables & Drawings

## TUSCAN

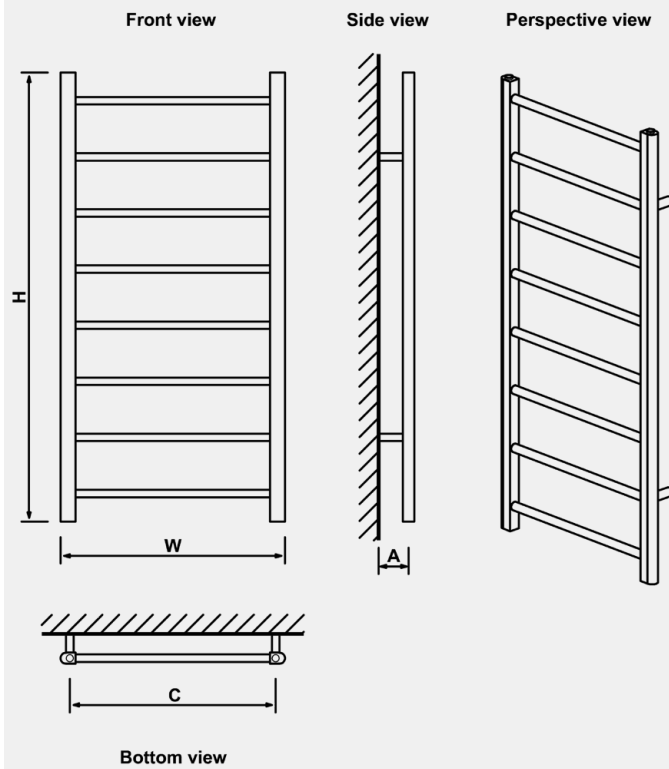

## BIAVA MULTIRAIL - STRAIGHT

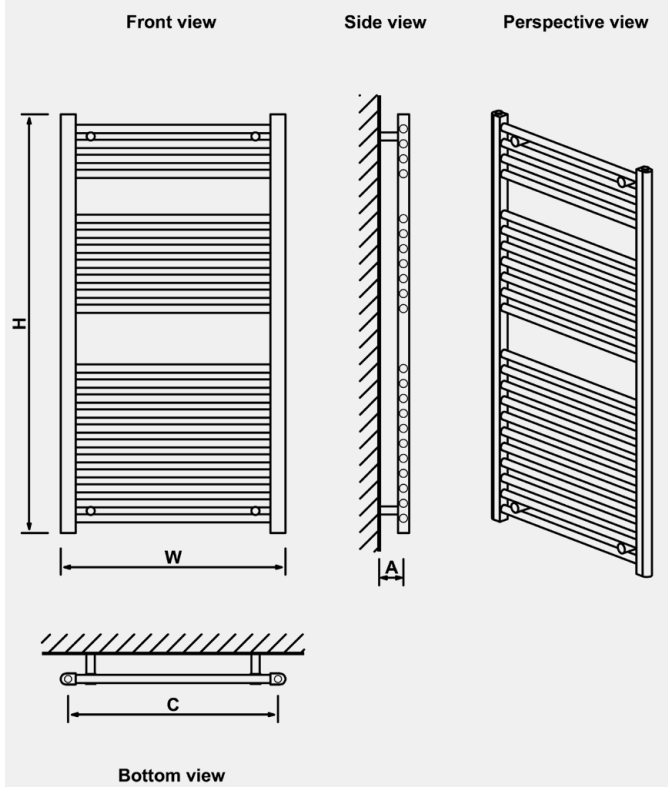

## BIAVA MULTIRAIL - CURVED

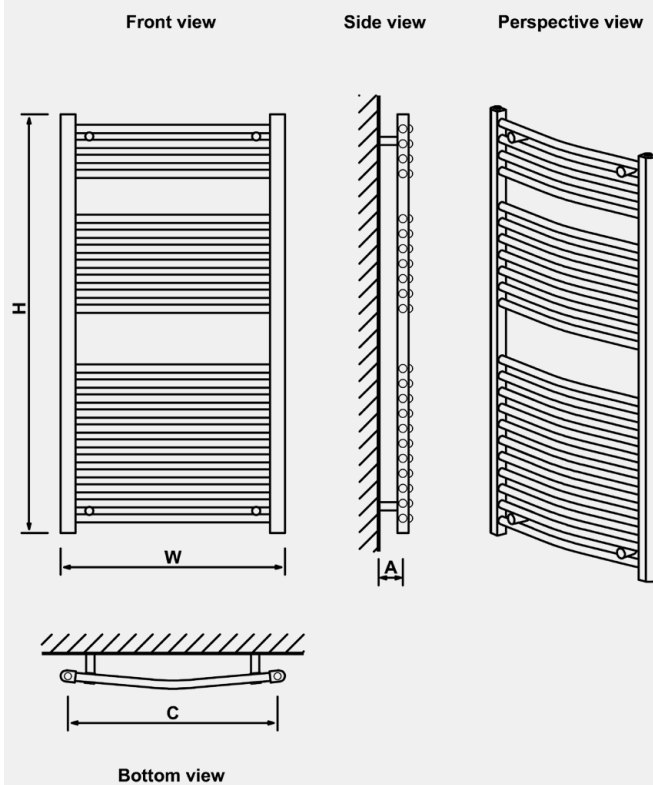

## BIAVA HIDDEN VENT (HV) - STRAIGHT

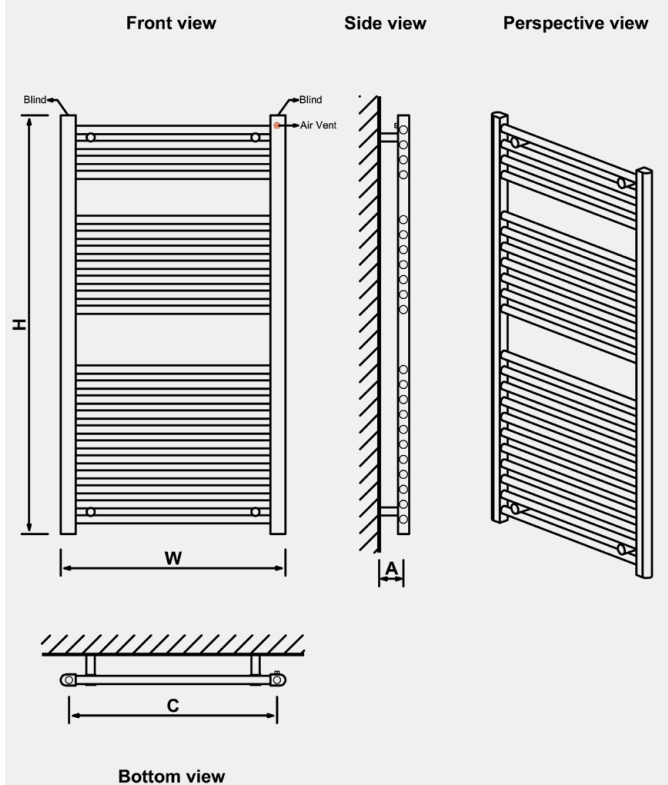

# Technical Tables & Drawings

## WESTWARD STRAIGHT - THE MULTIRAIL RANGE

### Westward - Straight

Height H (mm)	Width W (mm)	Tappings C (mm)	Distance from wall - D (mm)	Tappings from wall - A (mm)	Tube Qty	Water Content L	Weight KG	Colour	▲T60		Element Output	Element Type	Colour	▲T60		Element Output	Element Type
									Watts	BTU				Watts	BTU		
600	500	456	79	65	11	3.00	5.70	Coloured	371	1266	150W	A, A+, D, E, F, G	Chrome	245	836	150W	A, A+, D, E, F, G
600	600	556	79	65	11	3.50	6.40	Coloured	434	1481	150W	A, A+, D, E, F, G	Chrome	287	979	150W	A, A+, D, E, F, G
600	800	756	79	65	11	4.40	8.00	Coloured	560	1911	300W	A, A+, D, E, F, G	Chrome	371	1266	150W	A, A+, D, E, F, G
800	400	356	79	65	14	3.30	6.20	Coloured	399	1361	150W	A, A+, D, E, F, G	Chrome	263	897	150W	A, A+, D, E, F, G
800	500	456	79	65	14	3.90	7.20	Coloured	479	1634	300W	A, A+, D, E, F, G	Chrome	316	1078	150W	A, A+, D, E, F, G
800	600	556	79	65	14	4.50	8.20	Coloured	599	1907	300W	A, A+, D, E, F, G	Chrome	370	1262	150W	A, A+, D, E, F, G
1200	400	356	79	65	20	4.90	8.80	Coloured	550	1877	300W	A, A+, D, E, F, G	Chrome	375	1280	150W	A, A+, D, E, F, G
1200	500	456	79	65	20	5.70	10.30	Coloured	660	2252	300W	A, A+, D, E, F, G	Chrome	450	1535	150W	A, A+, D, E, F, G
1200	600	556	79	65	20	6.50	11.80	Coloured	768	2621	450W	A, A+, D, E, F, G	Chrome	524	1788	300W	A, A+, D, E, F, G
1800	400	356	79	65	30	7.30	13.00	Coloured	816	2784	450W	A, A+, D, E, F, G	Chrome	564	1924	300W	A, A+, D, E, F, G
1800	500	456	79	65	30	8.50	15.20	Coloured	978	3337	600W	A, A+, D, E, F, G	Chrome	677	2310	300W	A, A+, D, E, F, G
1800	600	556	79	65	30	9.80	17.40	Coloured	1140	3890	600W	A, A+, D, E, F, G	Chrome	788	2689	450W	A, A+, D, E, F, G

## RION MULTIRAIL - THE MULTIRAIL RANGE

### Rion Multirail

Height H (mm)	Width W (mm)	Tappings C (mm)	Distance from wall - D (mm)	Tappings from wall - A (mm)	Tube Qty	Water Content L	Weight KG	Colour	▲T60		Element Output	Element Type	Colour	▲T60		Element Output	Element Type
									Watts	BTU				Watts	BTU		
800	500	455	95	80	13	3.24	7.00	Coloured	419	1430	150W	A, A+, D, E, F, G	Chrome	269	918	100W	A, A+, D, E, F, G
800	600	555	95	80	13	3.65	8.20	Coloured	478	1631	150W	A, A+, D, E, F, G	Chrome	304	1038	100W	A, A+, D, E, F, G
1200	500	455	95	80	22	5.21	11.00	Coloured	649	2215	150W	A, A+, D, E, F, G	Chrome	420	1434	150W	A, A+, D, E, F, G
1200	600	555	95	80	22	5.89	13.03	Coloured	740	2525	300W	A, A+, D, E, F, G	Chrome	475	1621	150W	A, A+, D, E, F, G
1800	500	455	95	80	31	7.54	15.40	Coloured	985	3361	300W	A, A+, D, E, F, G	Chrome	653	2229	150W	A, A+, D, E, F, G
1800	600	555	95	80	31	8.50	18.40	Coloured	1122	3829	300W	A, A+, D, E, F, G	Chrome	738	2519	300W	A, A+, D, E, F, G

## CORINIUM ROUND - THE MULTIRAIL RANGE

### Corinium Round

Height H (mm)	Width W (mm)	Tappings C (mm)	Distance from wall - D (mm)	Tappings from wall - A (mm)	Tube Qty	Water Content L	Weight KG	Colour	▲T60		Element Output	Element Type	Colour	▲T60		Element Output	Element Type
									Watts	BTU				Watts	BTU		
800	500	458	106	85	12	3.90	5.07	Coloured	392	1338	150W	A, A+, D, E, F, G	Chrome	261	891	100W	A, A+, D, E, F, G
800	600	558	106	85	12	4.30	5.72	Coloured	458	1563	150W	A, A+, D, E, F, G	Chrome	305	1041	100W	A, A+, D, E, F, G
1200	500	458	106	85	18	5.80	7.43	Coloured	596	2034	150W	A, A+, D, E, F, G	Chrome	396	1352	150W	A, A+, D, E, F, G
1200	600	558	106	85	18	6.40	8.41	Coloured	696	2375	150W	A, A+, D, E, F, G	Chrome	462	1577	150W	A, A+, D, E, F, G
1800	500	458	106	85	27	8.70	10.98	Coloured	906	3092	300W	A, A+, D, E, F, G	Chrome	606	2068	150W	A, A+, D, E, F, G
1800	600	558	106	85	27	9.60	12.45	Coloured	1058	3610	300W	A, A+, D, E, F, G	Chrome	707	2413	150W	A, A+, D, E, F, G

## TUSCAN ROUND - THE MULTIRAIL RANGE

### Tuscan Round

Height H (mm)	Width W (mm)	Tappings C (mm)	Distance from wall - D (mm)	Tappings from wall - A (mm)	Tube Qty	Water Content L	Weight KG	Colour	▲T60		Element Output	Element Type	Colour	▲T60		Element Output	Element Type
									Watts	BTU				Watts	BTU		
800	500	458	106	85	7	3.10	4.04	Coloured	306	1045	100W	A, A+, D, E, F, G	Chrome	201	686	100W	A, A+, D, E, F, G
800	600	558	106	85	7	3.30	4.42	Coloured	352	1202	100W	A, A+, D, E, F, G	Chrome	232	792	100W	A, A+, D, E, F, G
1200	500	458	106	85	10	4.50	5.78	Coloured	459	1567	150W	A, A+, D, E, F, G	Chrome	303	1034	100W	A, A+, D, E, F, G
1200	600	558	106	85	10	4.80	6.33	Coloured	529	1805	150W	A, A+, D, E, F, G	Chrome	350	1195	100W	A, A+, D, E, F, G
1800	500	458	106	85	15	6.70	8.51	Coloured	688	2348	150W	A, A+, D, E, F, G	Chrome	454	1550	150W	A, A+, D, E, F, G
1800	600	558	106	85	15	7.20	9.32	Coloured	794	2710	300W	A, A+, D, E, F, G	Chrome	525	1792	150W	A, A+, D, E, F, G



Westward  
Straight



Rion Multirail



Corinium Round



Tuscan Round

# Technical Tables & Drawings

## WESTWARD - STRAIGHT

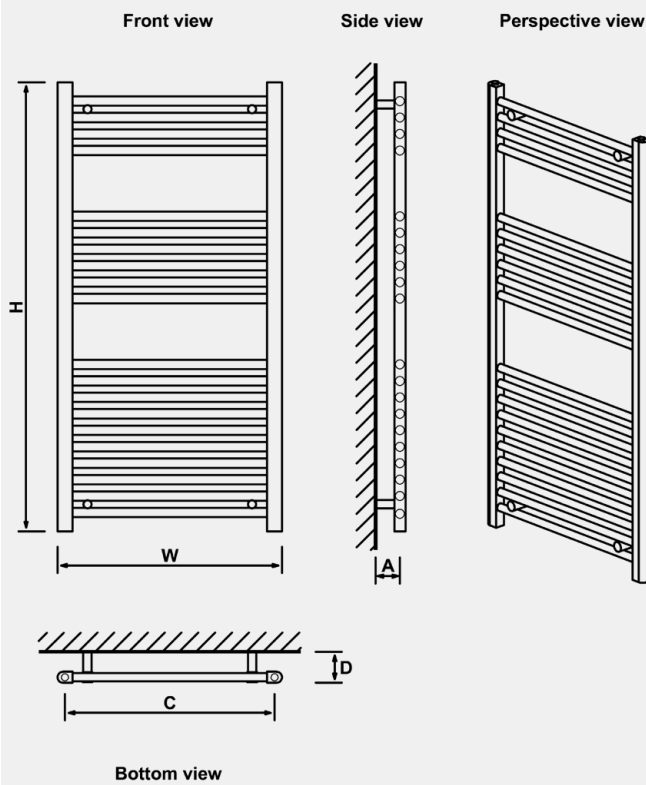

## RION MULTIRAIL

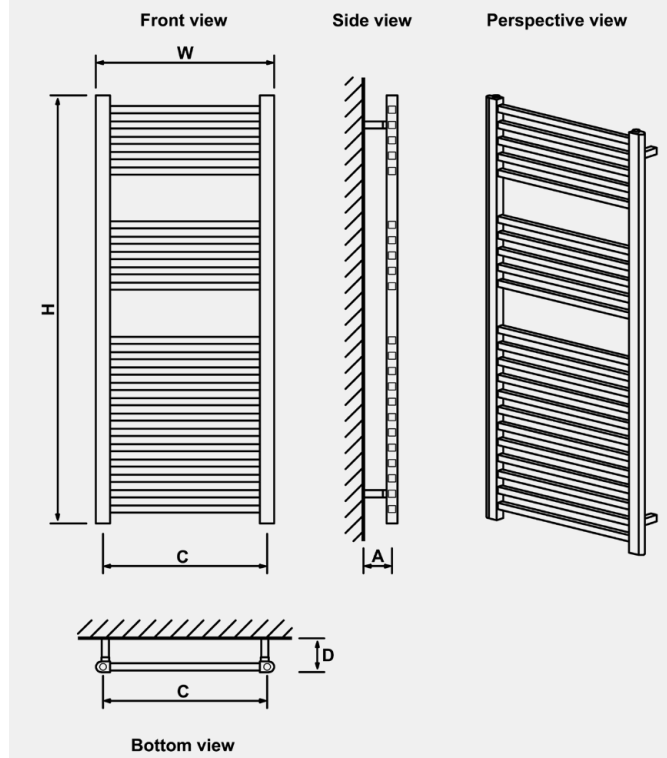

## CORINIUM ROUND

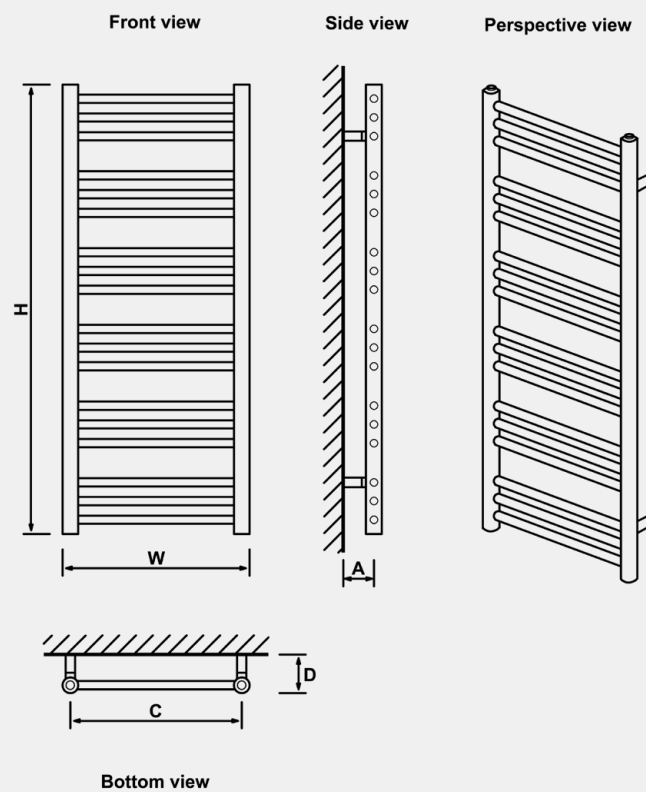

## TUSCAN ROUND

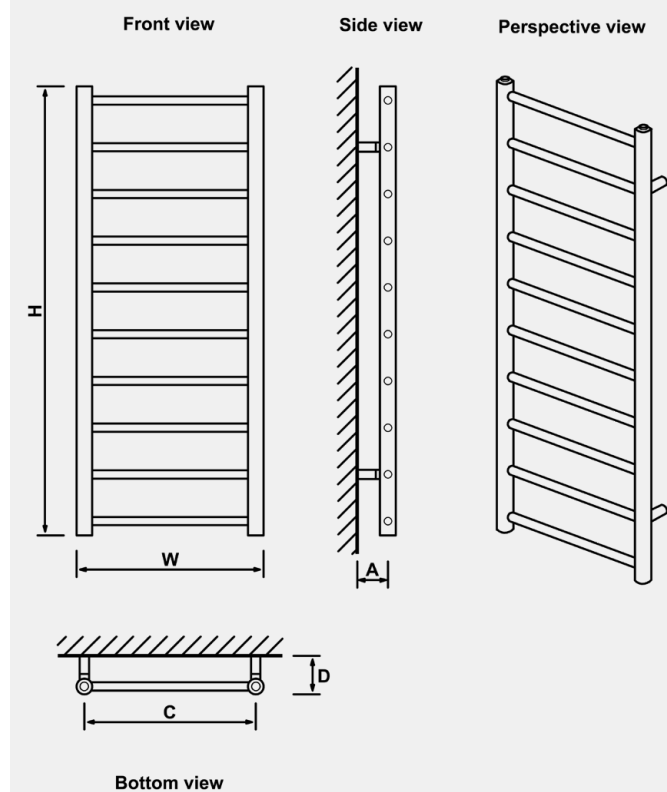

# Technical Tables & Drawings

## BIAVA ROUND - MULTIRAIL RANGE

### Biava Round

Height H (mm)	Width W (mm)	Tappings C (mm)	Tappings from wall - A (mm)	Distance from wall - D (mm)	Tube Qty	Water Content L	Weight KG	Colour	▲T60		Element Output	Element Type	Colour	▲T60		Element Output	Element Type
									Watts	BTU				Watts	BTU		
600	400	362	63-73	82-92	10	1.91	3.67	Coloured	218	744	100W	A, A+, D, E, F, G	Chrome	172	587	100W	A, A+, D, E, F, G
600	500	462	63-73	82-92	10	2.14	4.07	Coloured	257	877	150W	A, A+, D, E, F, G	Chrome	202	689	100W	A, A+, D, E, F, G
600	600	562	63-73	82-92	10	2.37	4.47	Coloured	296	1010	150W	A, A+, D, E, F, G	Chrome	234	798	150W	A, A+, D, E, F, G
1200	400	362	63-73	82-92	18	3.66	6.25	Coloured	412	1406	150W	A, A+, D, E, F, G	Chrome	324	1105	150W	A, A+, D, E, F, G
1200	500	462	63-73	82-92	18	4.08	6.97	Coloured	482	1645	300W	A, A+, D, E, F, G	Chrome	379	1293	150W	A, A+, D, E, F, G
1200	600	562	63-73	82-92	18	4.50	7.69	Coloured	552	1883	300W	A, A+, D, E, F, G	Chrome	435	1484	150W	A, A+, D, E, F, G
1800	400	362	63-73	82-92	27	5.50	8.96	Coloured	618	2109	300W	A, A+, D, E, F, G	Chrome	486	1658	300W	A, A+, D, E, F, G
1800	500	462	63-73	82-92	27	6.12	10.04	Coloured	723	2467	450W	A, A+, D, E, F, G	Chrome	569	1941	300W	A, A+, D, E, F, G
1800	600	562	63-73	82-92	27	6.75	11.12	Coloured	827	2822	450W	A, A+, D, E, F, G	Chrome	651	2221	300W	A, A+, D, E, F, G

## BIAVA TUBE ON TUBE - MULTIRAIL RANGE

### Biava Tube on Tube

Height H (mm)	Width W (mm)	Tappings C (mm)	Tappings from wall - A (mm)	Distance from wall - D (mm)	Tube Qty	Water Content L	Weight KG	Colour	▲T60		Element Output	Element Type	Colour	▲T60		Element Output	Element Type
									Watts	BTU				Watts	BTU		
600	400	350	51-66	85-100	10	1.72	3.34	-	-	-	-	-	Chrome	183	624	100W	A, A+, D, E, F, G
600	500	450	51-66	85-100	10	1.95	3.74	-	-	-	-	-	Chrome	214	730	100W	A, A+, D, E, F, G
600	600	550	51-66	85-100	10	2.18	4.14	-	-	-	-	-	Chrome	245	836	150W	A, A+, D, E, F, G
1200	400	350	51-66	85-100	25	3.89	7.05	-	-	-	-	-	Chrome	428	1460	150W	A, A+, D, E, F, G
1200	500	450	51-66	85-100	25	4.47	8.05	-	-	-	-	-	Chrome	505	1723	300W	A, A+, D, E, F, G
1200	600	550	51-66	85-100	25	5.05	9.05	-	-	-	-	-	Chrome	580	1979	300W	A, A+, D, E, F, G
1800	400	350	51-66	85-100	39	5.98	10.59	-	-	-	-	-	Chrome	661	2255	300W	A, A+, D, E, F, G
1800	500	450	51-66	85-100	39	6.88	12.15	-	-	-	-	-	Chrome	780	2661	450W	A, A+, D, E, F, G
1800	600	550	51-66	85-100	39	7.79	13.71	-	-	-	-	-	Chrome	898	3064	450W	A, A+, D, E, F, G

## LAUNTON - THE MULTIRAIL RANGE

### Launton

Height H (mm)	Width W (mm)	Tappings C (mm)	Distance from wall - D (mm)	Tappings from wall - A (mm)	Tube Qty	Water Content L	Weight KG	Colour	▲T60		Element Output	Element Type	Colour	▲T60		Element Output	Element Type
									Watts	BTU				Watts	BTU		
1200	500	470	255-270	70-85	11	4.00	8.30	Coloured	439	1496	150W	A, A+, D, E, F, G	Chrome	290	991	150W	A, A+, D, E, F, G
1200	600	570	255-270	70-85	11	4.40	9.30	Coloured	489	1670	300W	A, A+, D, E, F, G	Chrome	324	1106	150W	A, A+, D, E, F, G

## HADDENHAM - THE MULTIRAIL RANGE

### Haddenham

Height H (mm)	Width W (mm)	Tappings C (mm)	Distance from wall - D (mm)	Tappings from wall - A (mm)	Tube Qty	Water Content L	Weight KG	Colour	▲T60		Element Output	Element Type	Colour	▲T60		Element Output	Element Type
									Watts	BTU				Watts	BTU		
1200	500	455	255-270	70-85	25	6.10	9.50	Coloured	645	2200	300W	A, A+, D, E, F, G	Chrome	427	1457	150W	A, A+, D, E, F, G
1200	600	555	255-270	70-85	25	6.90	10.80	Coloured	732	2499	450W	A, A+, D, E, F, G	Chrome	485	1655	300W	A, A+, D, E, F, G



Biava Round



Biava Tube on Tube



Launton



Haddenham

# Technical Tables & Drawings

## BIAVA ROUND

## BIAVA TUBE ON TUBE

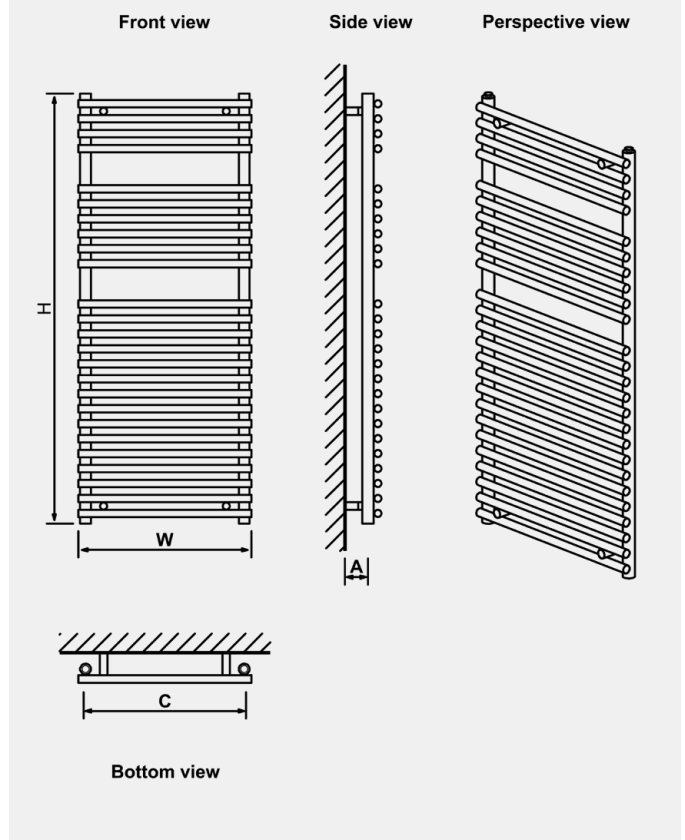
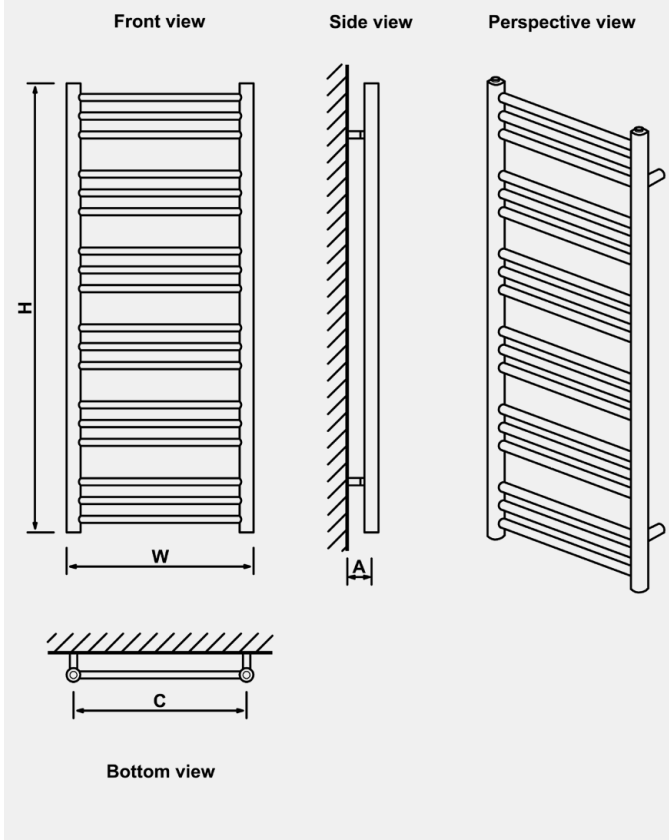

## LAUNTON

## HADDENHAM

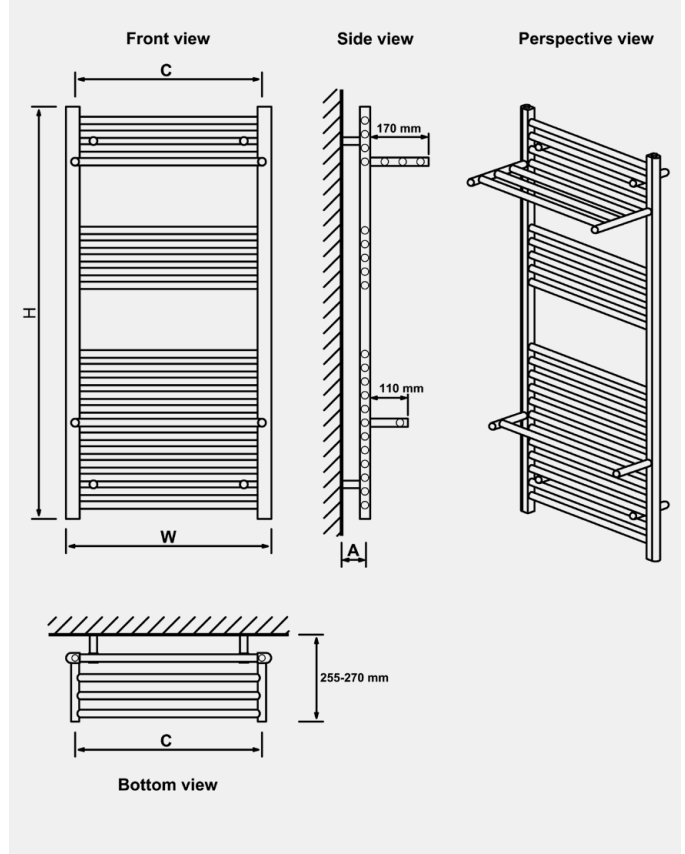
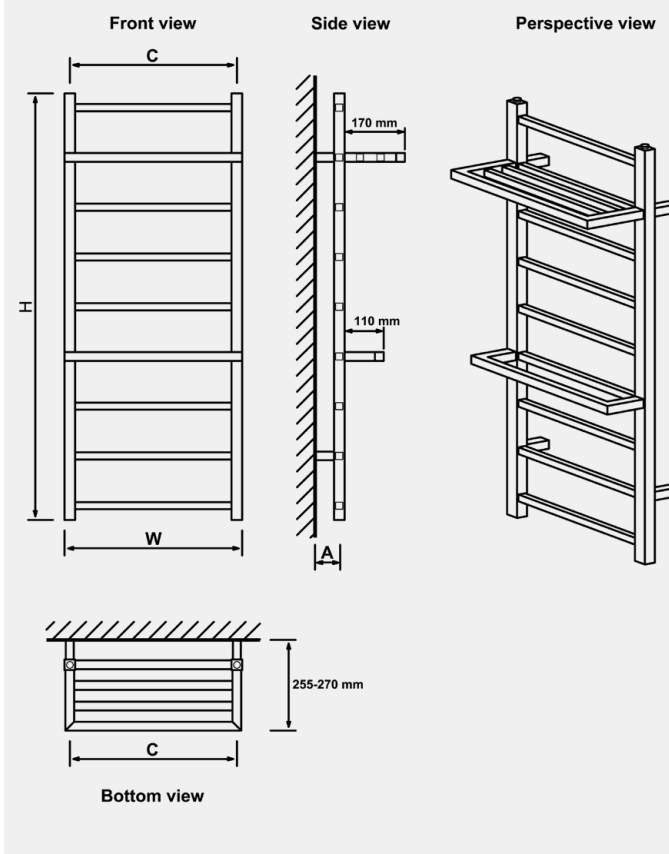

# Technical Tables & Drawings

## BIAVA SQUARE - MULTIRAIL RANGE

Biava Square																	
Height H (mm)	Width W (mm)	Tappings C (mm)	Tappings from wall - A (mm)	Distance from wall - D (mm)	Tube Qty	Water Content L	Weight KG	Colour	▲T60		Element Output	Element Type	Colour	▲T60		Element Output	Element Type
									Watts	BTU				Watts	BTU		
600	400	360	61-76	82-100	9	2.77	4.56	-	-	-	-	-	Chrome	221	754	100W	A, A+, D, E, F, G
600	500	460	61-76	82-100	9	3.12	5.19	-	-	-	-	-	Chrome	260	887	150W	A, A+, D, E, F, G
600	600	560	61-76	82-100	9	3.47	5.83	-	-	-	-	-	Chrome	299	1020	150W	A, A+, D, E, F, G
1200	400	360	61-76	82-100	23	6.17	9.77	-	-	-	-	-	Chrome	511	1744	300W	A, A+, D, E, F, G
1200	500	460	61-76	82-100	23	7.07	11.39	-	-	-	-	-	Chrome	612	2088	300W	A, A+, D, E, F, G
1200	600	560	61-76	82-100	23	7.97	13.02	-	-	-	-	-	Chrome	712	2429	300W	A, A+, D, E, F, G
1800	400	360	61-76	82-100	33	9.06	14.05	-	-	-	-	-	Chrome	746	2545	450W	A, A+, D, E, F, G
1800	500	460	61-76	82-100	33	10.35	16.38	-	-	-	-	-	Chrome	889	3033	450W	A, A+, D, E, F, G
1800	600	560	61-76	82-100	33	11.65	18.71	-	-	-	-	-	Chrome	1034	3528	600W	A, A+, D, E, F, G

## TUSCAN SQUARE - MULTIRAIL RANGE

Tuscan Square																	
Height H (mm)	Width W (mm)	Tappings C (mm)	Distance from wall - D (mm)	Tappings from wall - A (mm)	Tube Qty	Water Content L	Weight KG	Colour	▲T60		Element Output	Element Type	Colour	▲T60		Element Output	Element Type
									Watts	BTU				Watts	BTU		
800	500	470	95	80	7	2.10	4.60	Coloured	305	1041	100W	A, A+, D, E, F, G	Chrome	201	686	100W	A, A+, D, E, F, G
800	600	570	95	80	7	2.30	4.90	Coloured	349	1191	150W	A, A+, D, E, F, G	Chrome	231	789	100W	A, A+, D, E, F, G
1200	500	470	95	80	10	3.10	6.90	Coloured	460	1570	150W	A, A+, D, E, F, G	Chrome	302	1031	100W	A, A+, D, E, F, G
1200	600	570	95	80	10	3.40	7.10	Coloured	527	1799	150W	A, A+, D, E, F, G	Chrome	347	1184	150W	A, A+, D, E, F, G
1800	500	470	95	80	15	4.70	10.30	Coloured	688	2348	300W	A, A+, D, E, F, G	Chrome	458	1563	150W	A, A+, D, E, F, G
1800	600	570	95	80	15	5.10	11.00	Coloured	789	2693	300W	A, A+, D, E, F, G	Chrome	526	1795	150W	A, A+, D, E, F, G

## TUSCAN SQUARE MULTIRAIL - MULTIRAIL RANGE

Tuscan Square Multirail																	
Height H (mm)	Width W (mm)	Tappings C (mm)	Distance from wall - D (mm)	Tappings from wall - A (mm)	Tube Qty	Water Content L	Weight KG	Colour	▲T60		Element Output	Element Type	Colour	▲T60		Element Output	Element Type
									Watts	BTU				Watts	BTU		
800	500	470	95	80	13	2.94	8.53	Coloured	425	1451	150W	A, A+, D, E, F, G	Chrome	274	935	100W	A, A+, D, E, F, G
800	600	570	95	80	13	3.34	10.22	Coloured	497	1696	150W	A, A+, D, E, F, G	Chrome	316	1079	100W	A, A+, D, E, F, G
1200	500	470	95	80	22	4.75	11.9	Coloured	662	2259	150W	A, A+, D, E, F, G	Chrome	426	1454	150W	A, A+, D, E, F, G
1200	600	570	95	80	22	5.43	13.9	Coloured	775	2645	300W	A, A+, D, E, F, G	Chrome	491	1676	150W	A, A+, D, E, F, G
1800	500	470	95	80	31	6.85	16.89	Coloured	980	3344	300W	A, A+, D, E, F, G	Chrome	645	2201	150W	A, A+, D, E, F, G
1800	600	570	95	80	31	7.81	19.4	Coloured	1147	3914	300W	A, A+, D, E, F, G	Chrome	744	2539	300W	A, A+, D, E, F, G

## BIAVA DRY ELEMENT - DRY ELEMENT RANGE

Biava Dry Element																	
Height H (mm)	Width W (mm)	Tappings C (mm)	Distance from wall - D (mm)	Tappings from wall - A (mm)	Tube Qty	Water Content L	Weight KG	Colour	▲T60		Element Output	Element Type	Colour	▲T60		Element Output	Element Type
									Watts	BTU				Watts	BTU		
700	500	N/A	99-115	N/A	12	N/A	5.30	Coloured	250	853	N/A	N/A	Chrome	250	853	N/A	N/A
700	600	N/A	99-115	N/A	12	N/A	5.50	Coloured	300	1024	N/A	N/A	Chrome	300	1024	N/A	N/A
1100	500	N/A	99-115	N/A	20	N/A	7.50	Coloured	400	1365	N/A	N/A	Chrome	400	1365	N/A	N/A
1100	600	N/A	99-115	N/A	20	N/A	8.40	Coloured	500	1706	N/A	N/A	Chrome	500	1706	N/A	N/A



Biava Square



Tuscan Square



Tuscan Square Multirail



Biava Dry Element



# Technical Tables & Drawings

## BIAVA SQUARE

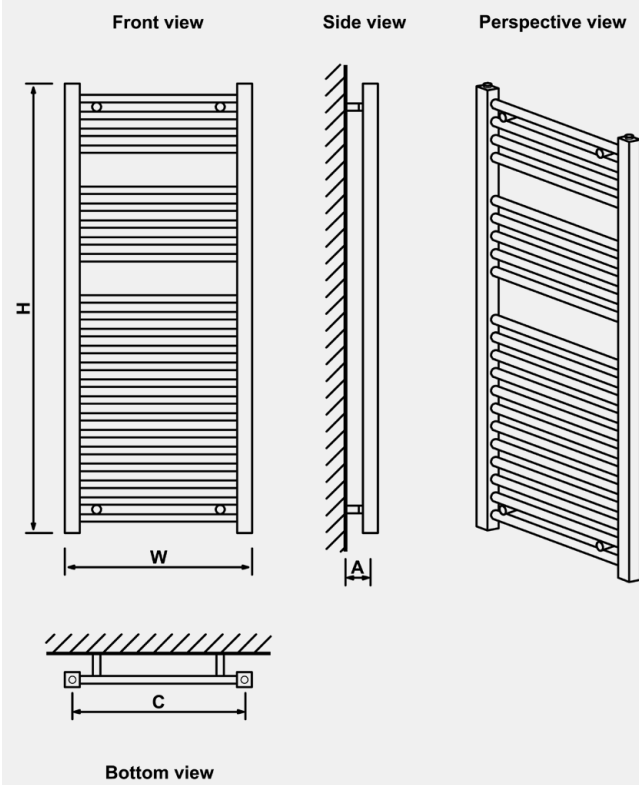

## TUSCAN SQUARE

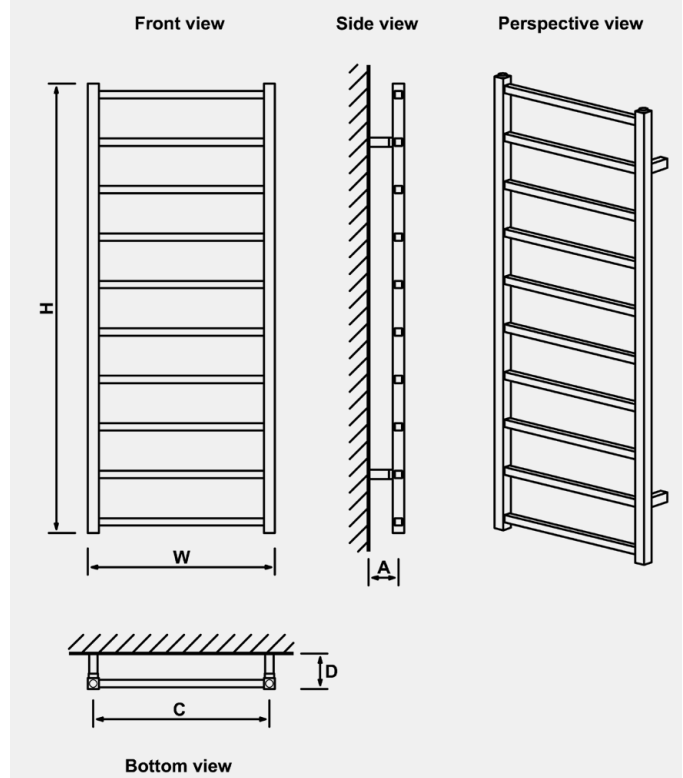

## TUSCAN SQUARE MULTIRAIL

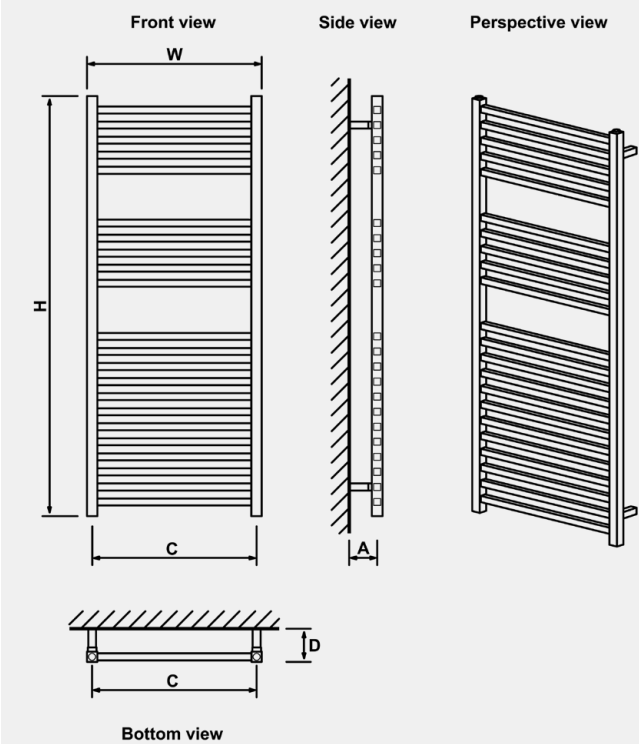

## BIAVA DRY ELEMENT

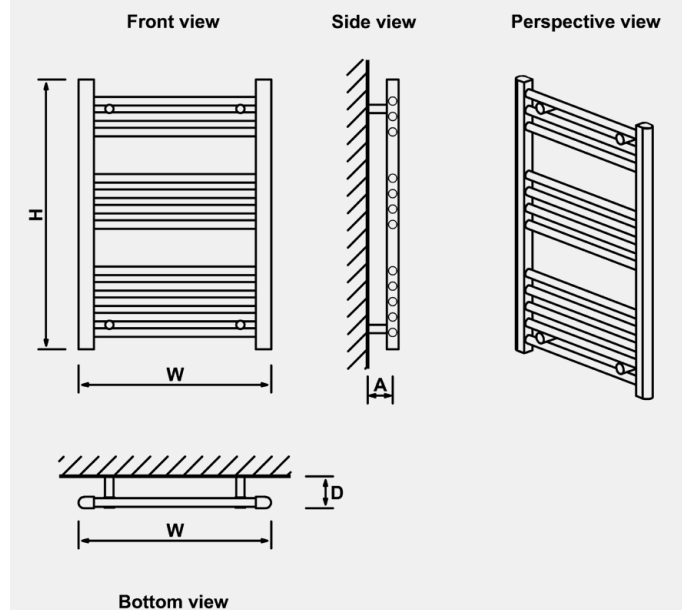

# Technical Tables & Drawings

## DERWENT ALUMINIUM DRY ELEMENT - DRY ELEMENT RANGE

### Derwent Aluminium Dry Element

Height H (mm)	Width W (mm)	Tappings C (mm)	Distance from wall - D (mm)	Tappings from wall - A (mm)	Tube Qty	Water Content L	Weight KG	Colour	▲T60		Element Output	Element Type	Colour		▲T60		Element Output	Element Type
									Watts	BTU			Watts	BTU				
1800	304	N/A	115	N/A	3	N/A	8.5	Coloured	600	2047	N/A	N/A	-	-	-	-	-	-
1800	404	N/A	115	N/A	4	N/A	11.3	Coloured	800	2730	N/A	N/A	-	-	-	-	-	-
1800	504	N/A	115	N/A	5	N/A	14.0	Coloured	1000	3412	N/A	N/A	-	-	-	-	-	-
1800	604	N/A	115	N/A	6	N/A	21.0	Coloured	1200	4094	N/A	N/A	-	-	-	-	-	-

## EMSBURY DRY ELEMENT - DRY ELEMENT RANGE

### Emsbury Dry Element

Height H (mm)	Width W (mm)	Tappings C (mm)	Distance from wall - D (mm)	Tappings from wall - A (mm)	Tube Qty	Water Content L	Weight KG	Colour	▲T60		Element Output	Element Type	Colour		▲T60		Element Output	Element Type
									Watts	BTU			Watts	BTU				
800	500	N/A	92	N/A	8	N/A	4.90	Polished	150	512	N/A	N/A	-	-	-	-	-	-
800	600	N/A	92	N/A	8	N/A	5.69	Polished	200	683	N/A	N/A	-	-	-	-	-	-
1200	500	N/A	92	N/A	12	N/A	6.55	Polished	250	854	N/A	N/A	-	-	-	-	-	-
1200	600	N/A	92	N/A	12	N/A	7.44	Polished	300	1024	N/A	N/A	-	-	-	-	-	-

## LODDON DRY ELEMENT - DRY ELEMENT RANGE

### Loddon Dry Element

Height H (mm)	Width W (mm)	Tappings C (mm)	Distance from wall - D (mm)	Tappings from wall - A (mm)	Tube Qty	Water Content L	Weight KG	Colour	▲T60		Element Output	Element Type	Colour		▲T60		Element Output	Element Type
									Watts	BTU			Watts	BTU				
800*	500	N/A	100	N/A	9	N/A	6.65	Coloured	300	1024	N/A	N/A	Chrome	300	1024	N/A	N/A	
800*	600	N/A	100	N/A	9	N/A	7.17	Coloured	350	1195	N/A	N/A	Chrome	350	1195	N/A	N/A	
1200	500	N/A	100	N/A	15	N/A	10.00	Coloured	450	1536	N/A	N/A	Chrome	450	1536	N/A	N/A	
1200	600	N/A	100	N/A	15	N/A	10.64	Coloured	500	1707	N/A	N/A	Chrome	500	1707	N/A	N/A	

\* The total height of this rail is 780mm

## KENNET DRY ELEMENT - DRY ELEMENT RANGE

### Kennet Dry Element

Height H (mm)	Width W (mm)	Tappings C (mm)	Distance from wall - D (mm)	Tappings from wall - A (mm)	Tube Qty	Water Content L	Weight KG	Colour	▲T60		Element Output	Element Type	Colour		▲T60		Element Output	Element Type
									Watts	BTU			Watts	BTU				
700*	500	N/A	130	N/A	3	N/A	7.47	Coloured	120	410	N/A	N/A	Chrome	120	410	N/A	N/A	
700*	600	N/A	130	N/A	3	N/A	8.52	Coloured	150	512	N/A	N/A	Chrome	150	512	N/A	N/A	
1200**	500	N/A	130	N/A	5	N/A	12.10	Coloured	200	683	N/A	N/A	Chrome	200	683	N/A	N/A	
1200**	600	N/A	130	N/A	5	N/A	13.66	Coloured	230	785	N/A	N/A	Chrome	230	785	N/A	N/A	

\* Height shown excludes bottom control leg. Total height is 744.5mm \*\* Height shown excludes bottom control leg. Total height is 1253mm



Derwent Dry Element



Emsbury Dry Element

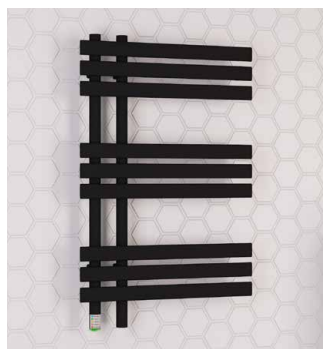

Loddon Dry Element



Kennet Dry Element

# Technical Tables & Drawings

## DERWENT DRY ELEMENT

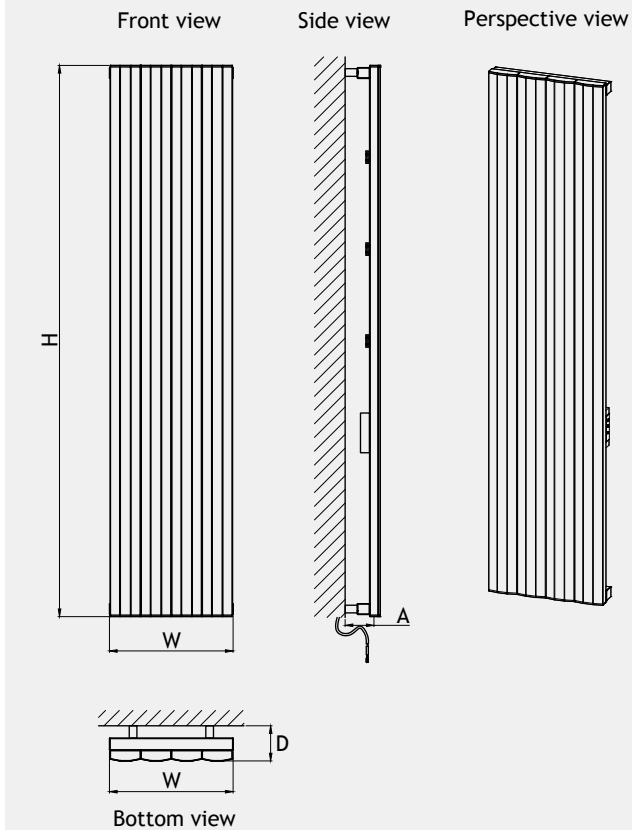

## EMSBURY DRY ELEMENT

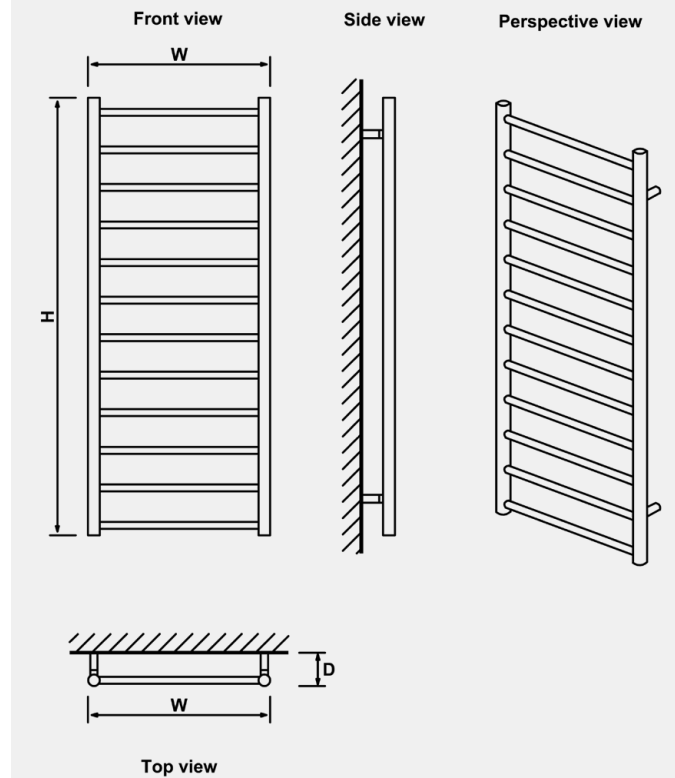

## LODDON DRY ELEMENT

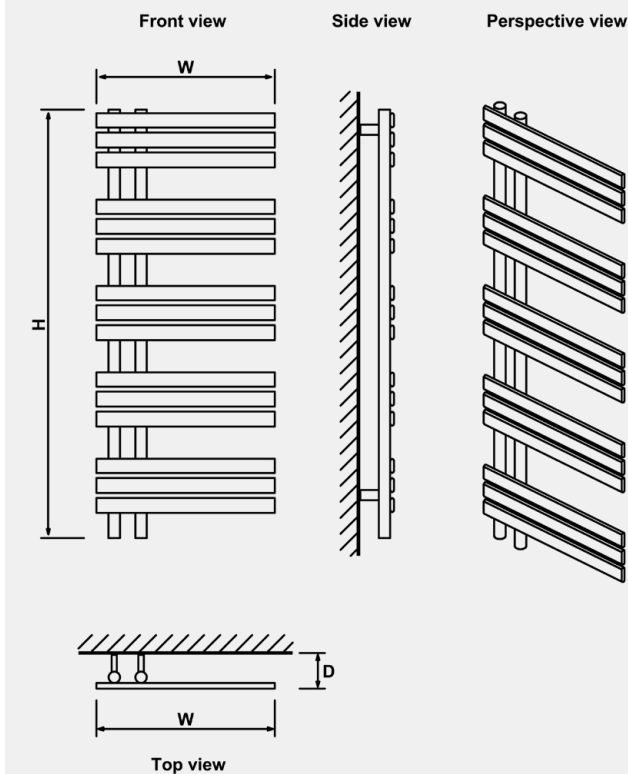

## KENNET DRY ELEMENT

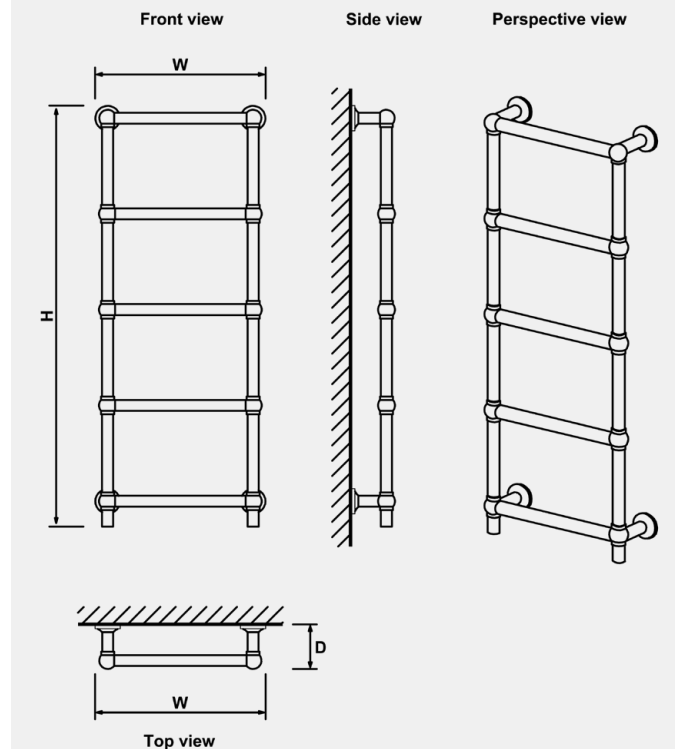

# Technical Tables & Drawings

## VIOLLA - STAINLESS STEEL RANGE

Violla												
Height H (mm)	Width W (mm)	Tappings C (mm)	Distance from wall - D (mm)	Tappings from wall - A (mm)	Tube Qty	Water Content L	Weight KG	Colour	▲T60		Element Output	Element Type
									Watts	BTU		
590	1000	968	100	84	6	2.14	3.40	Polished	231	788	150W	A, A+, D, E, F, G
790	500	468	100	84	9	2.00	3.20	Polished	199	679	100W	A, A+, D, E, F, G
790	600	568	100	84	9	2.22	3.60	Polished	226	771	150W	A, A+, D, E, F, G
1210	500	468	100	84	15	3.20	5.20	Polished	320	1092	150W	A, A+, D, E, F, G
1210	600	568	100	84	15	3.56	5.60	Polished	366	1249	150W	A, A+, D, E, F, G
1630	500	468	100	84	19	4.18	6.60	Polished	416	1419	150W	A, A+, D, E, F, G
1630	600	568	100	84	19	4.63	8.00	Polished	474	1617	300W	A, A+, D, E, F, G

## RIZANO - STAINLESS STEEL RANGE

Rizano												
Height H (mm)	Width W (mm)	Tappings C (mm)	Distance from wall - D (mm)	Tappings from wall - A (mm)	Tube Qty	Water Content L	Weight KG	Colour	▲T60		Element Output	Element Type
									Watts	BTU		
1000	500	50	95	65	15	3.50	7.50	Polished	545	1859	300W	A, A+, D, E
1000	600	50	95	65	15	4.10	9.60	Polished	626	2136	300W	A, A+, D, E

## BIAVA FLAT - STAINLESS STEEL RANGE

Biava Flat												
Height H (mm)	Width W (mm)	Tappings C (mm)	Distance from wall - D (mm)	Tappings from wall - A (mm)	Tube Qty	Water Content L	Weight KG	Colour	▲T60		Element Output	Element Type
									Watts	BTU		
1190	500	420	95	65	13	3.40	9.50	Polished	621	2119	300W	A, A+, D, E
1190	600	520	95	65	13	4.00	10.30	Polished	712	2429	300W	A, A+, D, E

## ASCONA - STAINLESS STEEL RANGE

Ascona												
Height H (mm)	Width W (mm)	Tappings C (mm)	Distance from wall - D (mm)	Tappings from wall - A (mm)	Tube Qty	Water Content L	Weight KG	Colour	▲T60		Element Output	Element Type
									Watts	BTU		
420	500	440	130	65	6	1.60	4.70	Polished	280	955	150W	A, A+, D, E



Violla



Rizano



Biava Flat



Ascona

# Technical Tables & Drawings

## VIOLLA

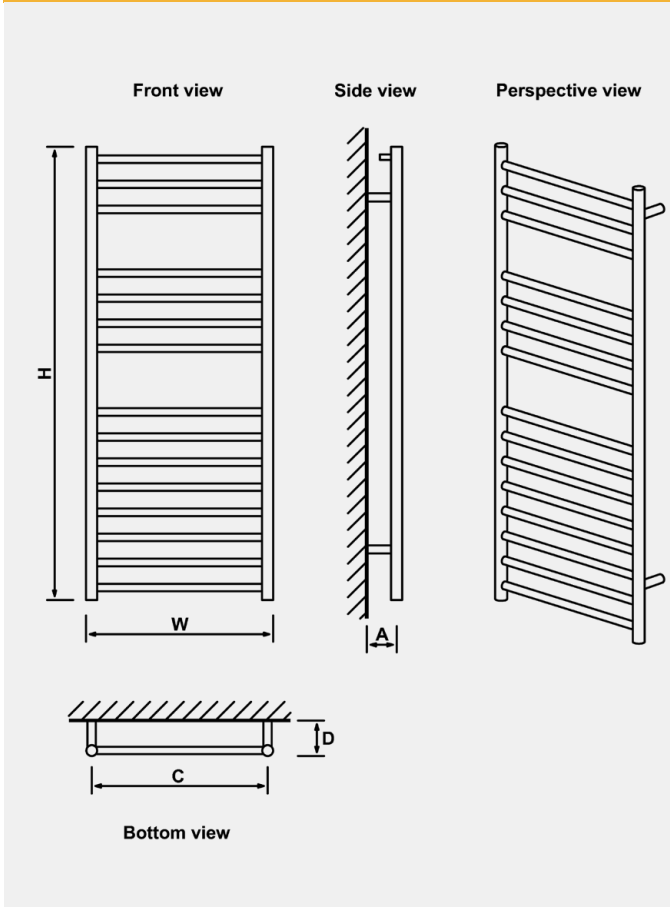

## RIZANO

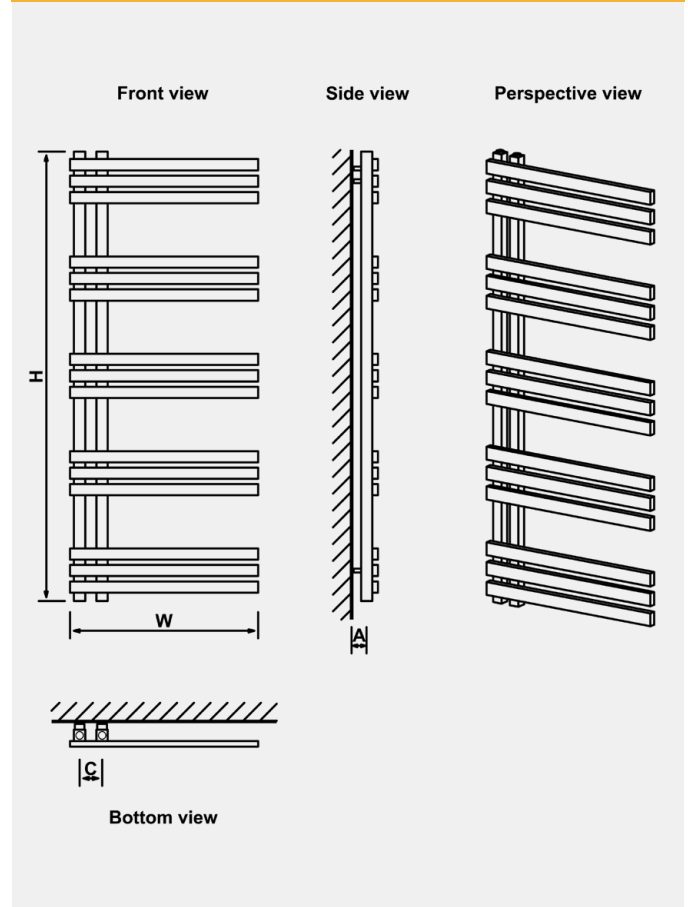

## BIAVA FLAT

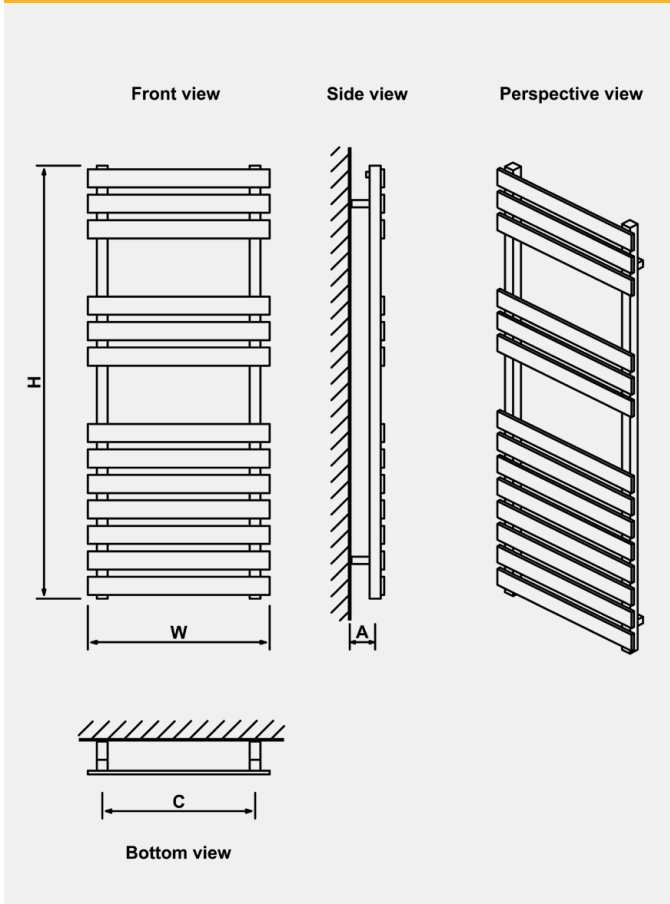

## ASCONA

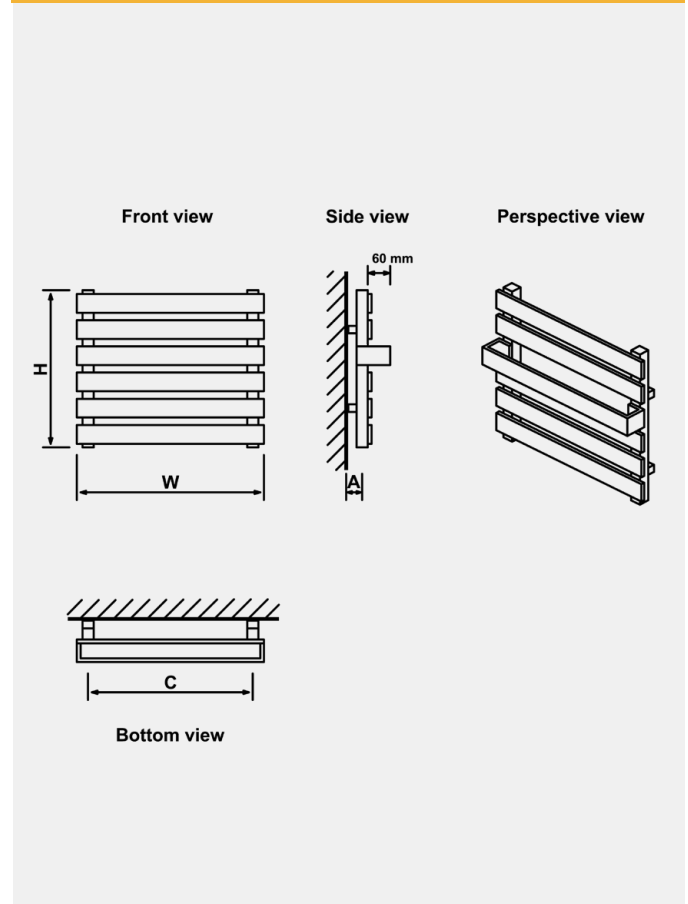

# Technical Tables & Drawings

## CONWY - DESIGNER RANGE

Conwy																	
Height H (mm)	Width W (mm)	Tappings C (mm)	Tappings from wall - A (mm)	Distance from wall - D (mm)	Tube Qty	Water Content L	Weight KG	Colour	▲T60		Element Output	Element Type	Colour	▲T60		Element Output	Element Type
									Watts	BTU				Watts	BTU		
1200	220	180	84-94	64-74	3	3.8	7.3	Coloured	244	833	100W	A,A+,D,E,F,G	Chrome	192	655	100W	A,A+,D,E,F,G

## PORTCHESTER - DESIGNER RANGE

Portchester																	
Height H (mm)	Width W (mm)	Tappings C (mm)	Tappings from wall - A (mm)	Distance from wall - D (mm)	Tube Qty	Water Content L	Weight KG	Colour	▲T60		Element Output	Element Type	Colour	▲T60		Element Output	Element Type
									Watts	BTU				Watts	BTU		
1200	225	180	89-99	67-77	3	3.70	6.7	Coloured	275	938	100W	A,A+,D,E,F,G	Chrome	219	747	100W	A,A+,D,E,F,G

## LEONARDO - DESIGNER RANGE

Leonardo																	
Height H (mm)	Width W (mm)	Tappings C (mm)	Tappings from wall - A (mm)	Distance from wall - D (mm)	Tube Qty	Water Content L	Weight KG	Colour	▲T60		Element Output	Element Type	Colour	▲T60		Element Output	Element Type
									Watts	BTU				Watts	BTU		
600	400	80	63-73	97-112	8	2.36	6.16	-	-	-	-	-	Chrome	244	833	150W	A, A+, D, E, F, G
600	500	80	63-73	97-112	8	2.71	8.95	-	-	-	-	-	Chrome	288	983	150W	A, A+, D, E, F, G
600	600	80	63-73	97-112	8	3.06	7.99	-	-	-	-	-	Chrome	332	1133	150W	A, A+, D, E, F, G
688	500	80	63-73	97-112	9	3.07	7.87	-	-	-	-	-	Chrome	324	1105	150W	A, A+, D, E, F, G
1200	400	80	63-73	97-112	15	4.54	10.92	-	-	-	-	-	Chrome	465	1587	150W	A, A+, D, E, F, G
1200	500	80	63-73	97-112	15	5.20	12.63	-	-	-	-	-	Chrome / Brushed Brass	548	1870	300W	A, A+, D, E, F, G
1200	600	80	63-73	97-112	15	5.85	14.34	-	-	-	-	-	Chrome / Brushed Brass	631	2153	300W	A, A+, D, E, F, G
1450	500	80	63-73	97-112	18	6.25	15.00	-	-	-	-	-	Chrome	658	2245	300W	A, A+, D, E, F, G
1800	400	80	63-73	97-112	21	6.55	15.19	-	-	-	-	-	Chrome	665	2269	300W	A, A+, D, E, F, G
1800	500	80	63-73	97-112	21	7.47	17.59	-	-	-	-	-	Chrome	780	2661	450W	A, A+, D, E, F, G
1800	600	80	63-73	97-112	21	8.39	19.99	-	-	-	-	-	Chrome	896	3057	450W	A, A+, D, E, F, G



Conwy



Portchester



Leonardo

# Technical Tables & Drawings

## CONWY

Front view

Side view

Perspective view

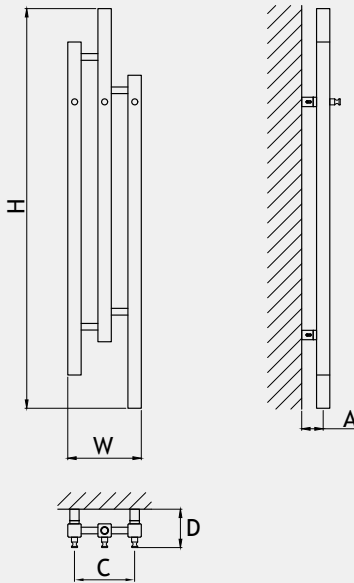

Bottom view

## PORTCHESTER

Front view

Side view

Perspective view

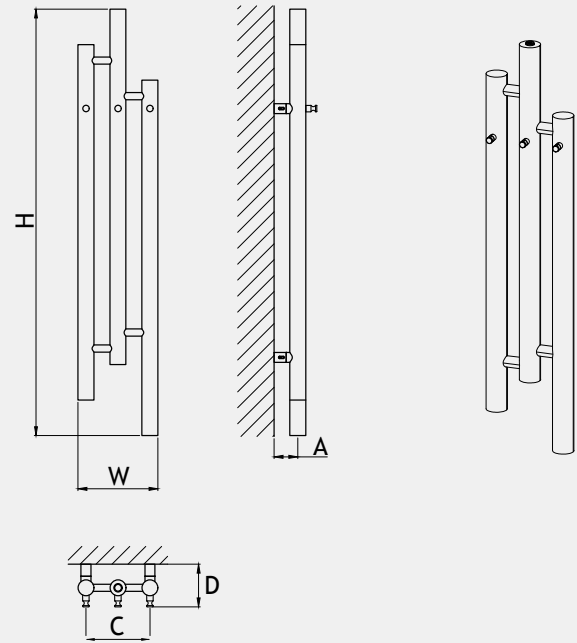

Bottom view

## LEONARDO

Front view

Side view

Perspective view

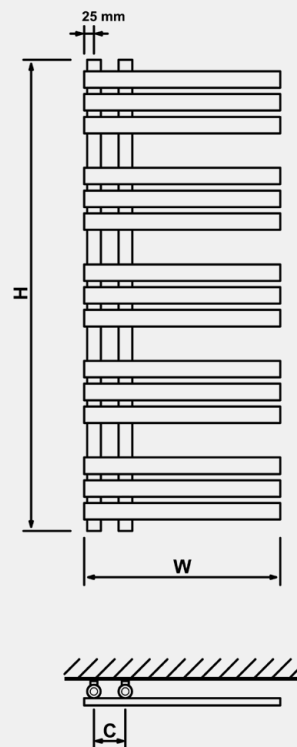

Bottom view

# Technical Tables & Drawings

## WARRINGTON TYPE 10 HORIZONTAL - DESIGNER RANGE

### Warrington Type 10 - Horizontal

Height H (mm)	Width W (mm)	Tappings C (mm)	Tappings from wall - A (mm)	Distance from wall - D (mm)	Tube Qty	Water Content L	Weight KG	Colour	▲T60		Element Output	Element Type	Colour	▲T60		Element Output	Element Type
									Watts	BTU				Watts	BTU		
600	452	452	84	51	6	-	7.2	Coloured	397	1355	N/A	N/A	-	-	-	-	-
600	604	604	84	51	8	-	9.5	Coloured	529	1805	N/A	N/A	-	-	-	-	-
600	832	832	84	51	11	-	13.1	Coloured	728	2484	N/A	N/A	-	-	-	-	-
600	1060	1060	84	51	14	-	16.6	Coloured	927	3163	N/A	N/A	-	-	-	-	-
600	1212	1212	84	51	16	-	19.0	Coloured	1060	3617	N/A	N/A	-	-	-	-	-

## WARRINGTON TYPE 10 VERTICAL - DESIGNER RANGE

### Warrington Type 10 - Vertical

Height H (mm)	Width W (mm)	Tappings C (mm)	Tappings from wall - A (mm)	Distance from wall - D (mm)	Tube Qty	Water Content L	Weight KG	Colour	▲T60		Element Output	Element Type	Colour	▲T60		Element Output	Element Type
									Watts	BTU				Watts	BTU		
1800	300	300	84	51	4	-	12.6	Coloured	705	2405	N/A	N/A	-	-	-	-	-
1800	376	376	84	51	5	-	15.8	Coloured	882	3009	N/A	N/A	-	-	-	-	-
1800	452	452	84	51	6	-	18.9	Coloured	1059	3613	N/A	N/A	-	-	-	-	-
1800	528	528	84	51	7	-	22.0	Coloured	1234	4210	N/A	N/A	-	-	-	-	-
1800	604	604	84	51	8	-	25.2	Coloured	1411	4814	N/A	N/A	-	-	-	-	-

## WARRINGTON TYPE 20 HORIZONTAL - DESIGNER RANGE

### Warrington Type 20 - Horizontal

Height H (mm)	Width W (mm)	Tappings C (mm)	Tappings from wall - A (mm)	Distance from wall - D (mm)	Tube Qty	Water Content L	Weight KG	Colour	▲T60		Element Output	Element Type	Colour	▲T60		Element Output	Element Type
									Watts	BTU				Watts	BTU		
600	456	456	84	51	12	-	13.2	Coloured	728	2484	N/A	N/A	-	-	-	-	-
600	608	608	84	51	16	-	17.6	Coloured	970	3310	N/A	N/A	-	-	-	-	-
600	836	836	84	51	22	-	24.2	Coloured	1335	4555	N/A	N/A	-	-	-	-	-
600	1064	1064	84	51	28	-	30.8	Coloured	1699	5797	N/A	N/A	-	-	-	-	-
600	1216	1216	84	51	32	-	35.2	Coloured	1942	6626	N/A	N/A	-	-	-	-	-

## WARRINGTON TYPE 20 VERTICAL - DESIGNER RANGE

### Warrington Type 20 - Vertical

Height H (mm)	Width W (mm)	Tappings C (mm)	Tappings from wall - A (mm)	Distance from wall - D (mm)	Tube Qty	Water Content L	Weight KG	Colour	▲T60		Element Output	Element Type	Colour	▲T60		Element Output	Element Type
									Watts	BTU				Watts	BTU		
1800	304	304	84	51	8	-	24.5	Coloured	1367	4664	N/A	N/A	-	-	-	-	-
1800	380	380	84	51	10	-	30.6	Coloured	1709	5831	N/A	N/A	-	-	-	-	-
1800	456	456	84	51	12	-	36.7	Coloured	2050	6995	N/A	N/A	-	-	-	-	-
1800	532	532	84	51	14	-	42.8	Coloured	2293	8165	N/A	N/A	-	-	-	-	-
1800	608	608	84	51	16	-	48.9	Coloured	2735	9332	N/A	N/A	-	-	-	-	-



Warrington Type 10 Horizontal



Warrington Type 10 Vertical



Warrington Type 20 Horizontal



Warrington Type 20 Vertical



# Technical Tables & Drawings

## WARRINGTON TYPE 10 HORIZONTAL

Perspective view

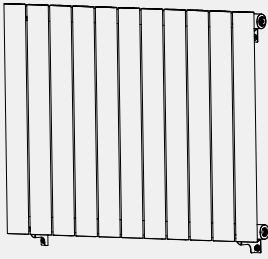

Front view

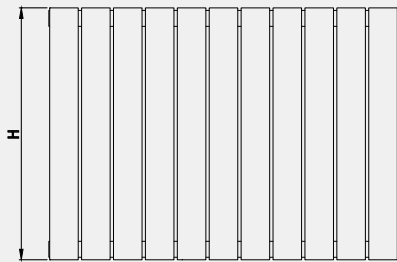

Side view

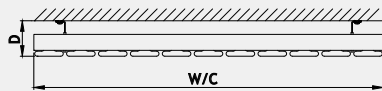

Bottom view

## WARRINGTON TYPE 10 VERTICAL

Front view

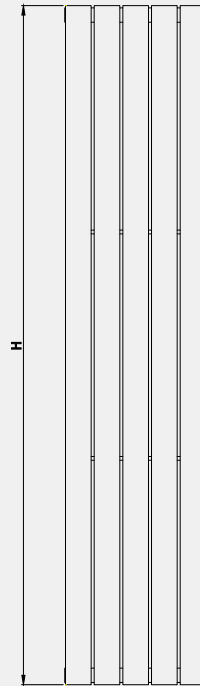

Side view



Perspective view

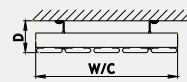
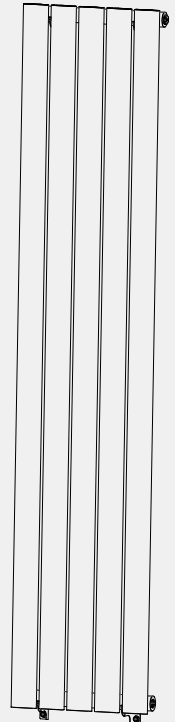

Bottom view

## WARRINGTON TYPE 20 HORIZONTAL

Perspective view

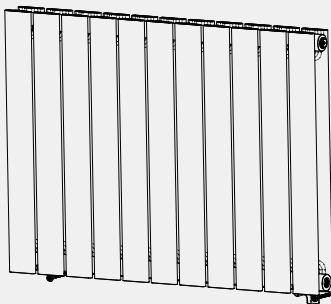

Front view

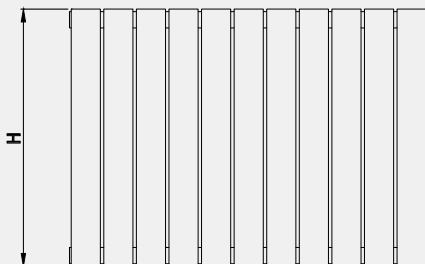

Side view

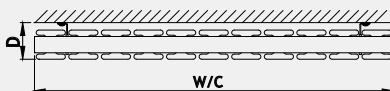

Bottom view

## WARRINGTON TYPE 10 VERTICAL

Front view

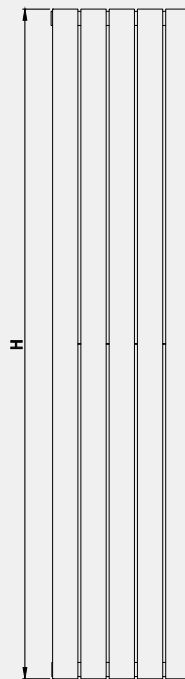

Side view

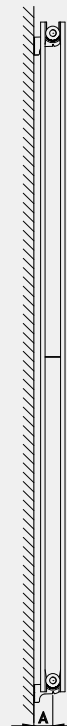

Perspective view

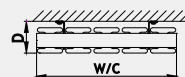
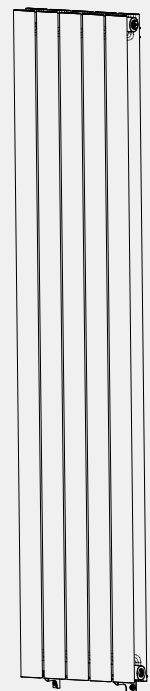

Bottom view

# Technical Tables & Drawings

## STAVERTON TUBE ON TUBE STRAIGHT - DESIGNER RANGE

### Staverton Tube on Tube - Straight

Height H (mm)	Width W (mm)	Tappings C (mm)	Tappings from wall - A (mm)	Distance from wall - D (mm)	Tube Qty	Water Content L	Weight KG	Colour	▲T60		Element Output	Element Type	Colour	▲T60		Element Output	Element Type
									Watts	BTU				Watts	BTU		
600	400	350	63-73	96-108	7	2.73	7.10	Coloured	364	1242	150W	A, A+, D, E, F, G	Chrome	288	983	150W	A, A+, D, E, F, G
600	500	450	63-73	96-108	7	3.13	8.21	Coloured	432	1474	150W	A, A+, D, E, F, G	Chrome	340	1160	150W	A, A+, D, E, F, G
600	600	550	63-73	96-108	7	3.53	9.32	Coloured	500	1706	300W	A, A+, D, E, F, G	Chrome	394	1344	150W	A, A+, D, E, F, G
600	1000	950	73-83	96-108	7	5.13	13.76	-	-	-	-	-	Chrome	603	2057	300W	A, A+, D, E, F, G
600	1200	1150	73-83	96-108	7	5.92	15.93	-	-	-	-	-	Chrome	710	2423	300W	A, A+, D, E, F, G
800	1000	950	73-83	96-108	9	6.65	17.50	-	-	-	-	-	Chrome	779	2658	450W	A, A+, D, E, F, G
800	1200	1150	73-83	96-108	9	7.67	20.23	-	-	-	-	-	Chrome	916	3125	450W	A, A+, D, E, F, G
1200	400	350	63-73	96-108	12	5.01	11.95	Coloured	651	2221	300W	A, A+, D, E, F, G	Chrome	514	1754	300W	A, A+, D, E, F, G
1200	500	450	63-73	96-108	12	5.69	13.85	Coloured	766	2614	450W	A, A+, D, E, F, G	Chrome / Brushed Brass	606	2068	300W	A, A+, D, E, F, G
1200	600	550	63-73	96-108	12	6.38	15.75	Coloured	883	3013	450W	A, A+, D, E, F, G	Chrome / Brushed Brass	697	2378	300W	A, A+, D, E, F, G
1800	400	350	63-73	96-108	19	7.75	18.13	Coloured	1014	3460	600W	A, A+, D, E, F, G	Chrome	802	2736	450W	A, A+, D, E, F, G
1800	500	450	63-73	96-108	19	8.82	21.14	Coloured	1198	4088	600W	A, A+, D, E, F, G	Chrome	946	3228	450W	A, A+, D, E, F, G

## STAVERTON TUBE ON TUBE CURVED - DESIGNER RANGE

### Staverton Tube on Tube - Curved

Height H (mm)	Width W (mm)	Tappings C (mm)	Tappings from wall - A (mm)	Distance from wall - D (mm)	Tube Qty	Water Content L	Weight KG	Colour	▲T60		Element Output	Element Type	Colour	▲T60		Element Output	Element Type
									Watts	BTU				Watts	BTU		
600	500	450	63-73	128-143	9	3.17	7.95	-	-	-	-	-	Chrome	328	1119	150W	A, A+, D, E, F, G
600	600	550	63-73	128-143	9	3.57	8.98	-	-	-	-	-	Chrome	378	1290	150W	A, A+, D, E, F, G
1200	500	450	63-73	128-143	17	6.12	14.36	-	-	-	-	-	Chrome	628	2143	300W	A, A+, D, E, F, G
1200	600	550	63-73	128-143	17	6.87	16.30	-	-	-	-	-	Chrome	722	2463	450W	A, A+, D, E, F, G
1800	500	450	63-73	128-143	25	9.07	20.77	-	-	-	-	-	Chrome	928	3166	450W	A, A+, D, E, F, G
1800	600	550	63-73	128-143	25	10.17	23.63	-	-	-	-	-	Chrome	1067	3641	600W	A, A+, D, E, F, G

## BIAVA CORINIUM - DESIGNER RANGE

### Biava Corinium

Height H (mm)	Width W (mm)	Tappings C (mm)	Distance from wall - D (mm)	Tappings from wall - A (mm)	Tube Qty	Water Content L	Weight KG	Colour	▲T60		Element Output	Element Type	Colour	▲T60		Element Output	Element Type
									Watts	BTU				Watts	BTU		
1200	500	470	225	43-58	8	3.87	6.20	-	-	-	-	-	Chrome	304	1037	150W	A, A+, C, E
1200	600	570	225	43-58	8	4.13	6.55	-	-	-	-	-	Chrome	330	1126	150W	A, A+, C, E

## DEFFORD - DESIGNER RANGE

### Defford

Height H (mm)	Width W (mm)	Tappings C (mm)	Distance from wall - D (mm)	Tappings from wall - A (mm)	Tube Qty	Water Content L	Weight KG	Colour	▲T60		Element Output	Element Type	Colour	▲T60		Element Output	Element Type
									Watts	BTU				Watts	BTU		
800	500	455	95	80	10	2.80	7.20	Coloured	405	1382	150W	A, A+, D, E, F, G	Chrome	250	853	150W	A, A+, D, E, F, G
800	600	555	95	80	10	3.00	8.30	Coloured	467	1594	150W	A, A+, D, E, F, G	Chrome	286	976	150W	A, A+, D, E, F, G
1200	500	455	95	80	16	4.30	11.20	Coloured	603	2058	300W	A, A+, D, E, F, G	Chrome	371	1266	150W	A, A+, D, E, F, G
1200	600	555	95	80	16	4.70	12.70	Coloured	695	2372	300W	A, A+, D, E, F, G	Chrome	424	1447	150W	A, A+, D, E, F, G
1800	500	455	95	80	22	6.20	15.10	Coloured	892	3044	450W	A, A+, D, E, F, G	Chrome	555	1894	300W	A, A+, D, E, F, G
1800	600	555	95	80	22	6.70	17.40	Coloured	1029	3511	450W	A, A+, D, E, F, G	Chrome	636	2171	300W	A, A+, D, E, F, G



Staverton Tube on Tube  
Straight



Staverton Tube on Tube  
Curved



Biava Corinium



Defford

# Technical Tables & Drawings

## STAVERTON TUBE ON TUBE - STRAIGHT

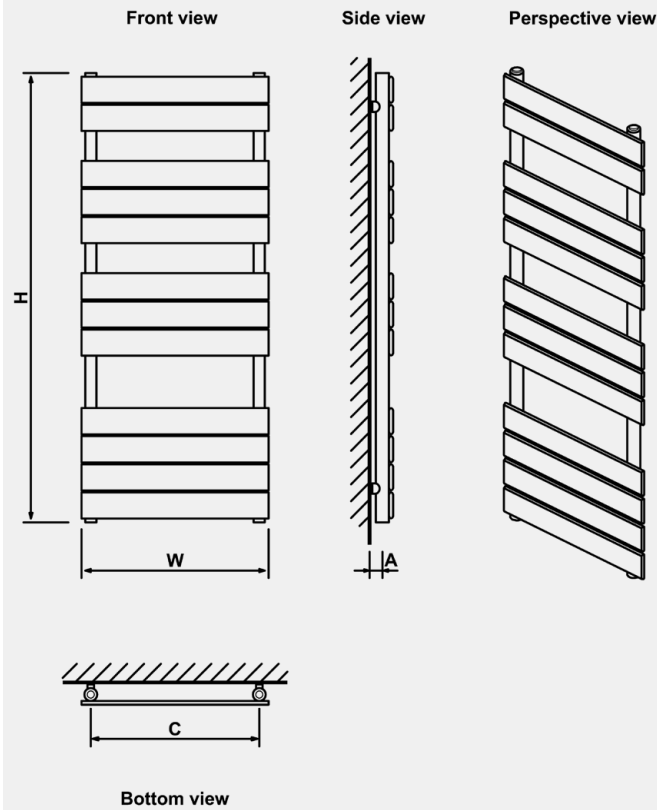

## STAVERTON TUBE ON TUBE - CURVED

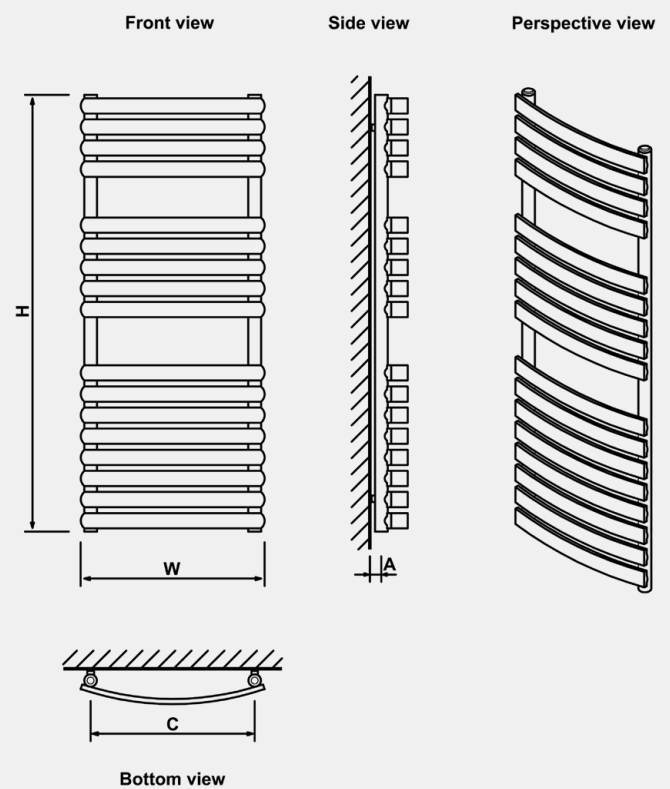

## BIAVA CORINIUM

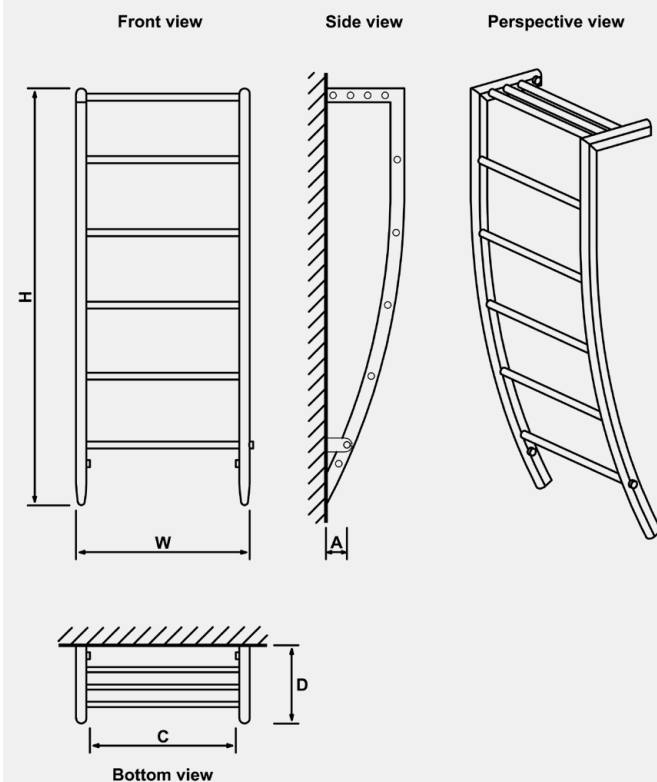

## DEFFORD

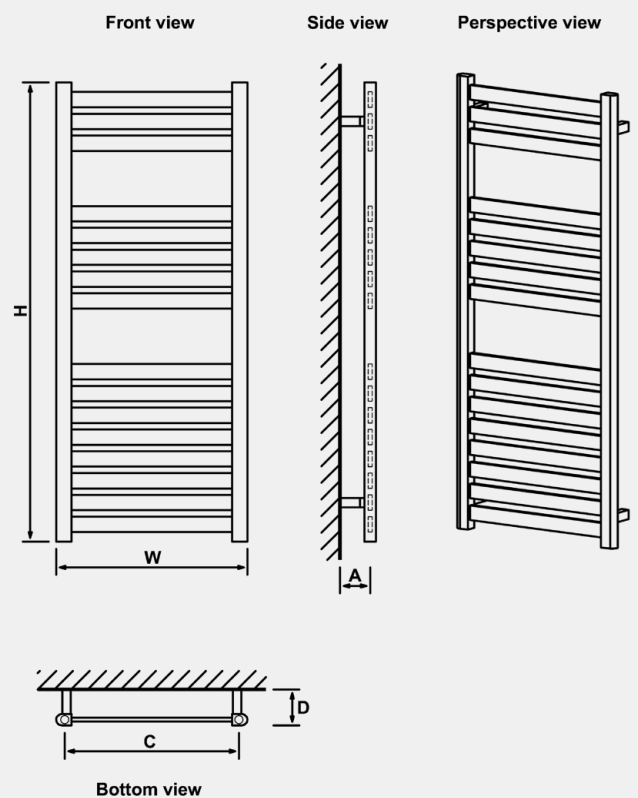

# Technical Tables & Drawings

## STAVERTON - DESIGNER RANGE

Staverton																	
Height H (mm)	Width W (mm)	Tappings C (mm)	Tappings from wall - A (mm)	Distance from wall - D (mm)	Tube Qty	Water Content L	Weight KG	Colour	▲T60		Element Output	Element Type	Colour	▲T60		Element Output	Element Type
									Watts	BTU				Watts	BTU		
600	400	350	66-81	80-100	8	2.23	9.02	Coloured	276	942	150W	A, A+, D, E, F, G	Chrome	217	740	100W	A, A+, D, E, F, G
600	500	450	66-81	80-100	8	2.58	9.94	Coloured	332	1133	150W	A, A+, D, E, F, G	Chrome	261	891	150W	A, A+, D, E, F, G
600	600	550	66-81	80-100	8	2.93	6.85	Coloured	388	1324	150W	A, A+, D, E, F, G	Chrome	305	1041	150W	A, A+, D, E, F, G
1200	400	350	66-81	80-100	16	4.45	9.61	Coloured	552	1883	300W	A, A+, D, E, F, G	Chrome	435	1484	150W	A, A+, D, E, F, G
1200	500	450	66-81	80-100	16	5.15	11.43	Coloured	665	2269	300W	A, A+, D, E, F, G	Chrome / Brushed Brass	523	1784	300W	A, A+, D, E, F, G
1200	600	550	66-81	80-100	16	5.85	13.26	Coloured	776	2648	450W	A, A+, D, E, F, G	Chrome / Brushed Brass	611	2085	300W	A, A+, D, E, F, G
1800	400	350	66-81	80-100	24	6.68	14.19	Coloured	829	2829	450W	A, A+, D, E, F, G	Chrome	652	2225	300W	A, A+, D, E, F, G
1800	500	450	66-81	80-100	24	7.73	16.93	Coloured	996	3398	600W	A, A+, D, E, F, G	Chrome	784	2675	450W	A, A+, D, E, F, G
1800	600	550	66-81	80-100	24	8.78	19.67	Coloured	1164	3972	600W	A, A+, D, E, F, G	Chrome	916	3125	450W	A, A+, D, E, F, G

## MEZZO TONDO - DESIGNER RANGE

Mezzo Tondo																	
Height H (mm)	Width W (mm)	Tappings C (mm)	Tappings from wall - A (mm)	Distance from wall - D (mm)	Tube Qty	Water Content L	Weight KG	Colour	▲T60		Element Output	Element Type	Colour	▲T60		Element Output	Element Type
									Watts	BTU				Watts	BTU		
1600	320	286	63-73	247-257	26	5.11	10.03	-	-	-	-	-	Chrome	574	1958	N/A	N/A

## PESARO - DESIGNER RANGE

Pesaro																	
Height H (mm)	Width W (mm)	Tappings C (mm)	Tappings from wall - A (mm)	Distance from wall - D (mm)	Tube Qty	Water Content L	Weight KG	Colour	▲T60		Element Output	Element Type	Colour	▲T60		Element Output	Element Type
									Watts	BTU				Watts	BTU		
1005	550	80	65-80	115-130	12	4.09	5.88	-	-	-	-	-	Chrome	349	1191	150W	A, A+, D, E

## SANTERO - DESIGNER RANGE

Santero																	
Height H (mm)	Width W (mm)	Tappings C (mm)	Distance from wall - D (mm)	Tappings from wall - A (mm)	Tube Qty	Water Content L	Weight KG	Colour	▲T60		Element Output	Element Type	Colour	▲T60		Element Output	Element Type
									Watts	BTU				Watts	BTU		
800	500	455	95	80	7	3.90	9.10	Coloured	430	1468	150W	A, A+, D, E, F, G	Chrome	249	850	150W	A, A+, D, E, F, G
800	600	555	95	80	7	4.50	9.50	Coloured	509	1737	150W	A, A+, D, E, F, G	Chrome	289	987	150W	A, A+, D, E, F, G
1200	500	455	95	80	10	5.70	11.70	Coloured	633	2160	300W	A, A+, D, E, F, G	Chrome	373	1273	150W	A, A+, D, E, F, G
1200	600	555	95	80	10	6.50	14.00	Coloured	749	2556	300W	A, A+, D, E, F, G	Chrome	434	1481	150W	A, A+, D, E, F, G
1800	500	455	95	80	15	8.60	16.50	Coloured	932	3180	450W	A, A+, D, E, F, G	Chrome	551	1881	300W	A, A+, D, E, F, G
1800	600	555	95	80	15	9.80	19.70	Coloured	1104	3767	450W	A, A+, D, E, F, G	Chrome	641	2188	300W	A, A+, D, E, F, G



Staverton



Mezzo Tondo



Pesaro



Santero

# Technical Tables & Drawings

## STAVERTON

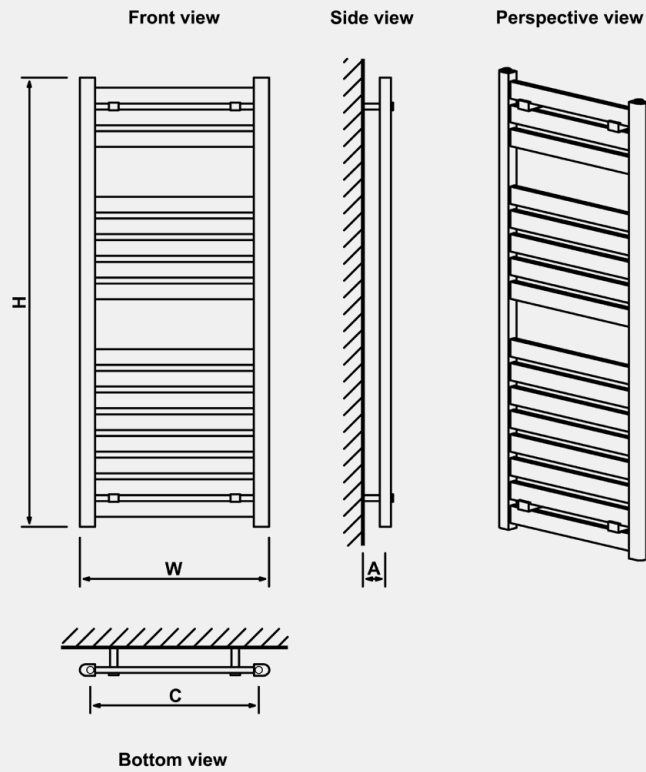

## MEZZO TONDO

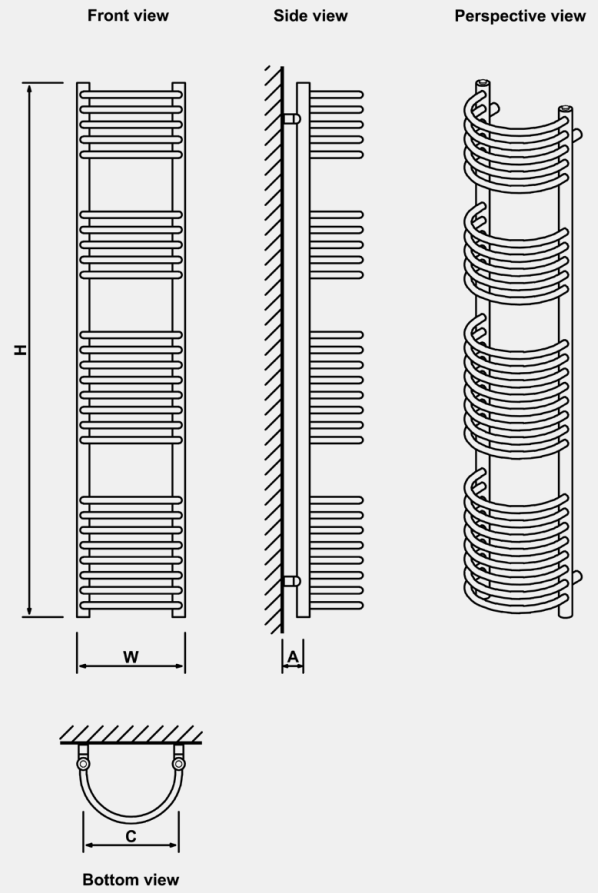

## PESARO

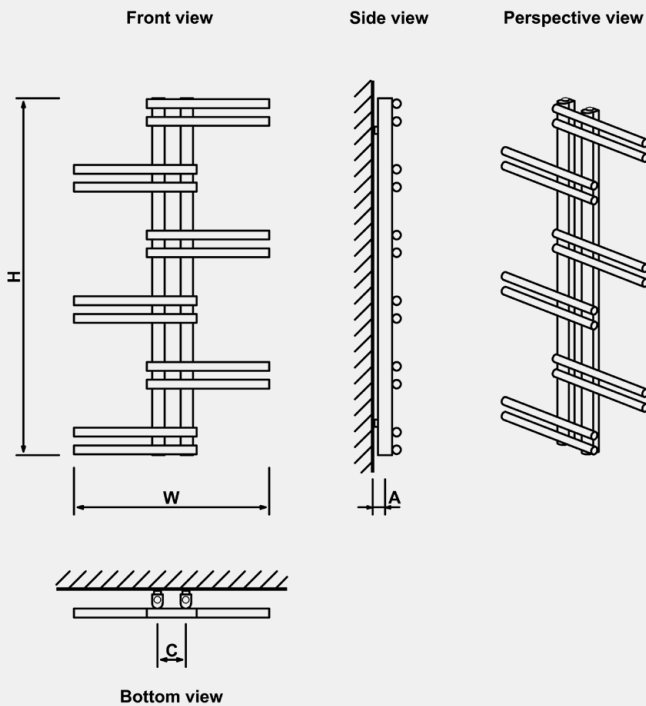

## SANTERO

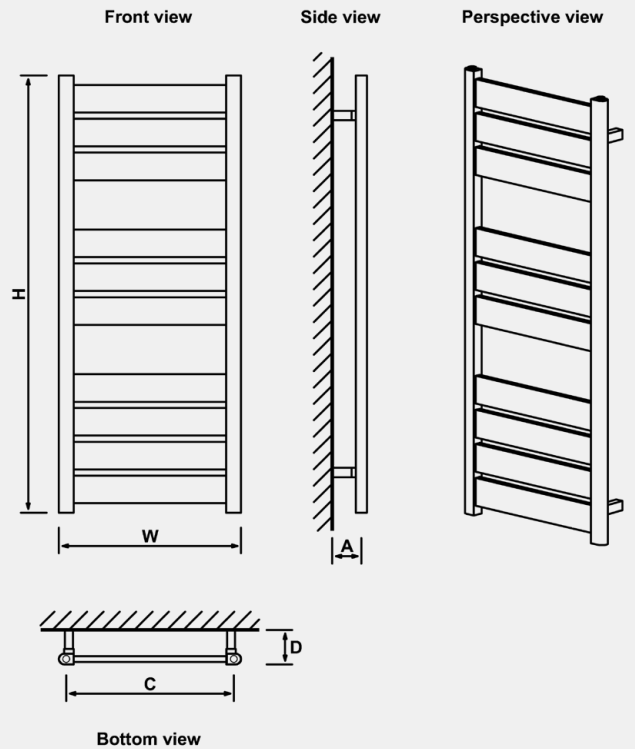

# Technical Tables & Drawings

## HURLEY - DESIGNER RANGE

Hurley																		
Height H (mm)	Width W (mm)	Tappings C (mm)	Distance from wall - D (mm)	Tappings from wall - A (mm)	Tube Qty	Water Content L	Weight KG	Colour	▲T60		Element Output	Element Type	Colour	▲T60		Element Output	Element Type	
									Watts	BTU					Watts	BTU		
800	500	60	104	79	9	2.90	9.70	Coloured	368	1256	150W	A, A+, D, E, F, G	Chrome	239	816	150W	A, A+, D, E, F, G	
800	600	60	104	79	9	3.60	11.20	Coloured	414	1413	150W	A, A+, D, E, F, G	Chrome	268	915	150W	A, A+, D, E, F, G	
1000	500	60	104	79	12	3.01	11.50	Coloured	460	1570	150W	A, A+, D, E, F, G	Chrome	298	1017	150W	A, A+, D, E, F, G	
1000	600	60	104	79	12	3.32	12.80	Coloured	517	1765	300W	A, A+, D, E, F, G	Chrome	334	1140	150W	A, A+, D, E, F, G	
1200	500	60	104	79	15	4.30	14.50	Coloured	551	1881	300W	A, A+, D, E, F, G	Chrome	356	1215	150W	A, A+, D, E, F, G	
1200	600	60	104	79	15	5.70	16.00	Coloured	619	2113	300W	A, A+, D, E, F, G	Chrome	399	1362	150W	A, A+, D, E, F, G	
1500	500	60	104	79	18	4.52	16.70	Coloured	684	2334	300W	A, A+, D, E, F, G	Chrome	441	1505	150W	A, A+, D, E, F, G	
1500	600	60	104	79	18	4.98	18.60	Coloured	768	2621	450W	A, A+, D, E, F, G	Chrome	494	1686	300W	A, A+, D, E, F, G	
1800	500	60	104	79	21	6.80	18.50	Coloured	813	2774	450W	A, A+, D, E, F, G	Chrome	522	1782	300W	A, A+, D, E, F, G	
1800	600	60	104	79	21	7.50	20.00	Coloured	913	3116	450W	A, A+, D, E, F, G	Chrome	585	1997	300W	A, A+, D, E, F, G	

## HELMSLEY - DESIGNER RANGE

Helmsley																		
Height H (mm)	Width W (mm)	Tappings C (mm)	Distance from wall - D (mm)	Tappings from wall - A (mm)	Tube Qty	Water Content L	Weight KG	Colour	▲T60		Element Output	Element Type	Colour	▲T60		Element Output	Element Type	
									Watts	BTU					Watts	BTU		
800	500	50	106	79	9	3.51	10.3	Coloured	437	1492	300W	A, A+, D, E, F, G	-	-	-	-	-	
800	600	50	106	79	9	3.98	14.5	Coloured	506	1727	300W	A, A+, D, E, F, G	-	-	-	-	-	
1150	500	50	106	79	12	4.81	16.9	Coloured	607	2072	300W	A, A+, D, E, F, G	-	-	-	-	-	
1150	600	50	106	79	12	5.43	19.2	Coloured	703	2399	450W	A, A+, D, E, F, G	-	-	-	-	-	
1400	500	50	106	79	15	5.95	20.6	Coloured	736	2512	450W	A, A+, D, E, F, G	-	-	-	-	-	
1400	600	50	106	79	15	6.74	23.3	Coloured	853	2911	600W	A, A+, D, E, F, G	-	-	-	-	-	
1640	500	50	106	79	18	7.09	24.1	Coloured	869	2966	600W	A, A+, D, E, F, G	-	-	-	-	-	
1640	600	50	106	79	18	8.03	28.1	Coloured	1007	3436	600W	A, A+, D, E, F, G	-	-	-	-	-	

## PLATANI - DESIGNER RANGE

Platani																		
Height H (mm)	Width W (mm)	Tappings C (mm)	Distance from wall - D (mm)	Tappings from wall - A (mm)	Tube Qty	Water Content L	Weight KG	Colour	▲T60		Element Output	Element Type	Colour	▲T60		Element Output	Element Type	
									Watts	BTU					Watts	BTU		
800	500	50	115	80	6	3.10	5.60	Coloured	339	1157	150W	A, A+, D, E, F, G	Chrome	216	737	100W	A, A+, D, E, F, G	
800	600	50	115	80	6	3.40	7.90	Coloured	389	1328	150W	A, A+, D, E, F, G	Chrome	247	843	100W	A, A+, D, E, F, G	
1150	500	50	115	80	8	4.20	9.40	Coloured	467	1594	150W	A, A+, D, E, F, G	Chrome	299	1021	150W	A, A+, D, E, F, G	
1150	600	50	115	80	8	4.70	10.60	Coloured	535	1826	150W	A, A+, D, E, F, G	Chrome	342	1167	150W	A, A+, D, E, F, G	
1800	500	50	115	80	12	6.40	14.60	Coloured	703	2399	300W	A, A+, D, E, F, G	Chrome	455	1553	150W	A, A+, D, E, F, G	
1800	600	50	115	80	12	7.20	15.60	Coloured	806	2751	300W	A, A+, D, E, F, G	Chrome	520	1775	150W	A, A+, D, E, F, G	

## REINBACH - DESIGNER RANGE

Reinbach																		
Height H (mm)	Width W (mm)	Tappings C (mm)	Distance from wall - D (mm)	Tappings from wall - A (mm)	Tube Qty	Water Content L	Weight KG	Colour	▲T60		Element Output	Element Type	Colour	▲T60		Element Output	Element Type	
									Watts	BTU					Watts	BTU		
800	500	50	125	80	12	5.50	10,4	Coloured	466	1590	150W	A, A+, D, E, F, G	-	-	-	-	-	
800	600	50	125	80	12	6.40	11,9	Coloured	556	1898	300W	A, A+, D, E, F, G	-	-	-	-	-	
1200	500	50	125	80	16	7.60	13,6	Coloured	671	2290	300W	A, A+, D, E, F, G	-	-	-	-	-	
1200	600	50	125	80	16	8.70	15,6	Coloured	802	2737	300W	A, A+, D, E, F, G	-	-	-	-	-	
1800	500	50	125	80	24	11.40	21,1	Coloured	976	3331	450W	A, A+, D, E, F, G	-	-	-	-	-	
1800	600	50	125	80	24	13.10	23,7	Coloured	1166	3979	600W	A, A+, D, E, F, G	-	-	-	-	-	



Hurley



Helmsley



Platani



Reinbach

# Technical Tables & Drawings

## HURLEY

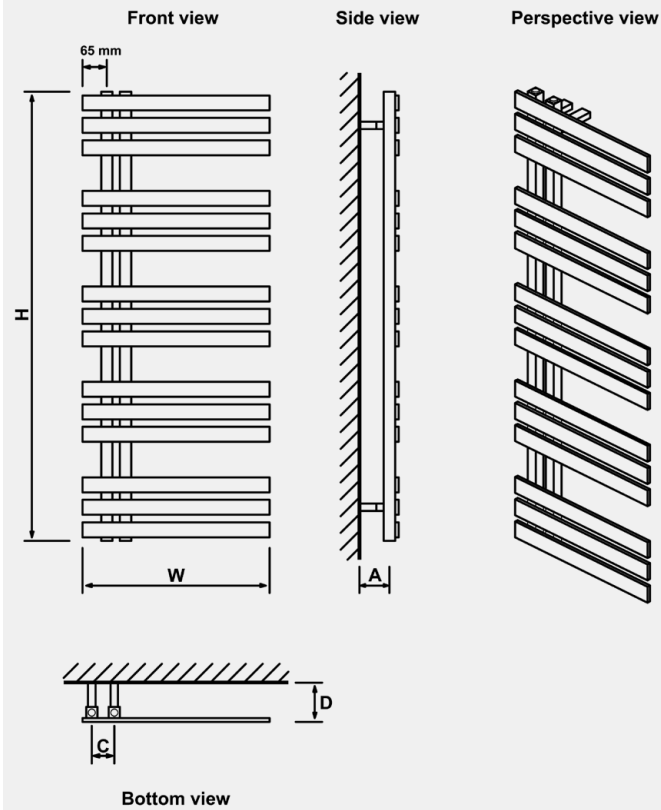

## HELMSLEY

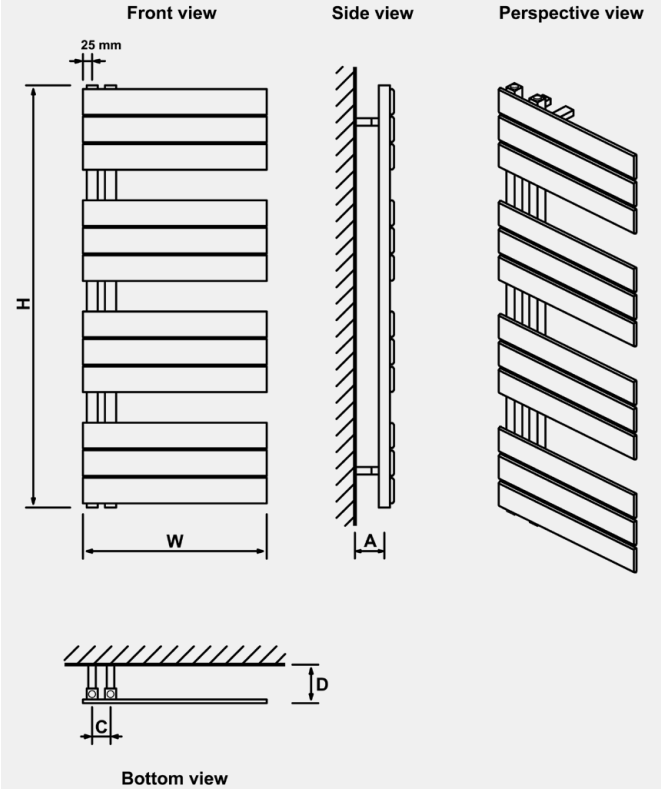

## PLATANI

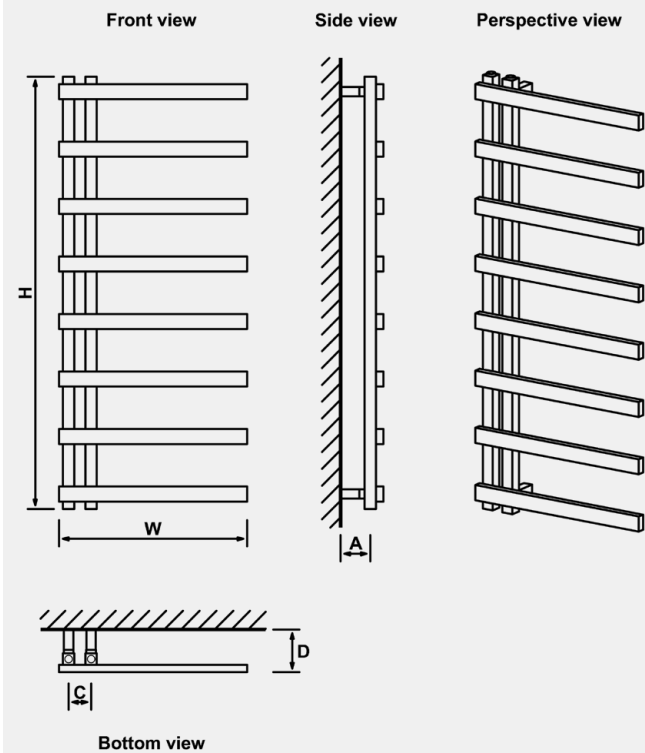

## REINBACH

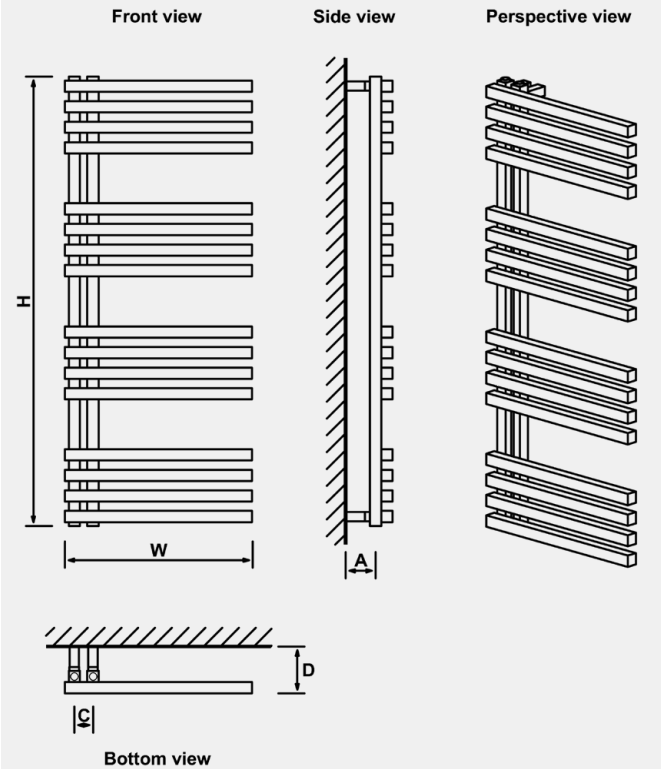

# Technical Tables & Drawings

## MARLOW - DESIGNER RANGE

Marlow																	
Height H (mm)	Width W (mm)	Tappings C (mm)	Distance from wall - D (mm)	Tappings from wall - A (mm)	Tube Qty	Water Content L	Weight KG	Colour	▲T60		Element Output	Element Type	Colour	▲T60		Element Output	Element Type
									Watts	BTU				Watts	BTU		
850	500	418	127	85	6	4.90	8.50	Coloured	399	1362	N/A	N/A	Chrome	257	877	N/A	N/A
850	600	518	127	85	6	5.60	10.00	Coloured	452	1543	N/A	N/A	Chrome	293	1000	N/A	N/A
1150	500	418	127	85	8	6.60	11.00	Coloured	534	1823	N/A	N/A	Chrome	344	1174	N/A	N/A
1150	600	518	127	85	8	7.50	13.00	Coloured	606	2068	N/A	N/A	Chrome	392	1338	N/A	N/A
1750	500	418	127	85	12	10.00	16.50	Coloured	804	2744	N/A	N/A	Chrome	520	1775	N/A	N/A
1750	600	518	127	85	12	11.30	18.50	Coloured	912	3112	N/A	N/A	Chrome	594	2027	N/A	N/A

## MARLOW E-STYLE - DESIGNER RANGE

Marlow E-Style																	
Height H (mm)	Width W (mm)	Tappings C (mm)	Distance from wall - D (mm)	Tappings from wall - A (mm)	Tube Qty	Water Content L	Weight KG	Colour	▲T60		Element Output	Element Type	Colour	▲T60		Element Output	Element Type
									Watts	BTU				Watts	BTU		
850	500	50	127	85	6	4.90	8.50	Coloured	371	1266	N/A	N/A	Chrome	242	826	N/A	N/A
850	600	50	127	85	6	5.60	10.00	Coloured	422	1440	N/A	N/A	Chrome	274	935	N/A	N/A
1150	500	50	127	85	8	6.60	11.00	Coloured	497	1696	N/A	N/A	Chrome	325	1109	N/A	N/A
1150	600	50	127	85	8	7.50	13.00	Coloured	566	1932	N/A	N/A	Chrome	368	1256	N/A	N/A
1750	500	50	127	85	12	10.00	16.50	Coloured	756	2580	N/A	N/A	Chrome	491	1676	N/A	N/A
1750	600	50	127	85	12	11.30	18.50	Coloured	861	2938	N/A	N/A	Chrome	555	1894	N/A	N/A

## LAMBOURNE VERTICAL - DESIGNER RANGE

Lambourne Vertical																	
Height H (mm)	Width W (mm)	Tappings C1* - C2** (mm)	Distance from wall - D (mm)	Tappings from wall - A1* - A2**(mm)	Tube Qty	Water Content L	Weight KG	Colour	▲T60		Element Output	Element Type	Colour	▲T60		Element Output	Element Type
									Watts	BTU				Watts	BTU		
1200	420	420 / 240	127	85 / 106	7	9.36	13.82	Coloured	649	2215	150W	A, A+, D, E, F, G	Chrome	426	1454	150W	A, A+, D, E, F, G
1200	540	540 / 360	127	85 / 106	9	12.04	17.31	Coloured	837	2856	300W	A, A+, D, E, F, G	Chrome	549	1874	150W	A, A+, D, E, F, G
1800	420	420 / 240	127	85 / 106	7	14.38	20.32	Coloured	888	3030	300W	A, A+, D, E, F, G	Chrome	652	2225	150W	A, A+, D, E, F, G
1800	540	540 / 360	127	85 / 106	9	18.48	25.60	Coloured	1146	3911	450W	A, A+, D, E, F, G	Chrome	842	2873	300W	A, A+, D, E, F, G

\* Tappings C1/A1 : Tappings for side installation \*\* Tappings C2/A2 : Tappings for bottom installation

## MURANO VERTICAL - DESIGNER RANGE

Murano - Vertical																	
Height H (mm)	Width W (mm)	Tappings C (mm)	Distance from wall - D (mm)	Tappings from wall - A (mm)	Tube Qty	Water Content L	Weight KG	Colour	▲T60		Element Output	Element Type	Colour	▲T60		Element Output	Element Type
									Watts	BTU				Watts	BTU		
1800	310	310	86	50	12	6.90	13.80	Coloured	947	3232	N/A	N/A	-	-	-	-	-
1800	410	410	86	50	16	9.20	18.40	Coloured	1301	4440	N/A	N/A	-	-	-	-	-
1800	510	510	86	50	20	11.50	23.40	Coloured	1667	5688	N/A	N/A	-	-	-	-	-



Marlow



Marlow E-Style



Lambourne Vertical



Murano Vertical



# Technical Tables & Drawings

## MARLOW

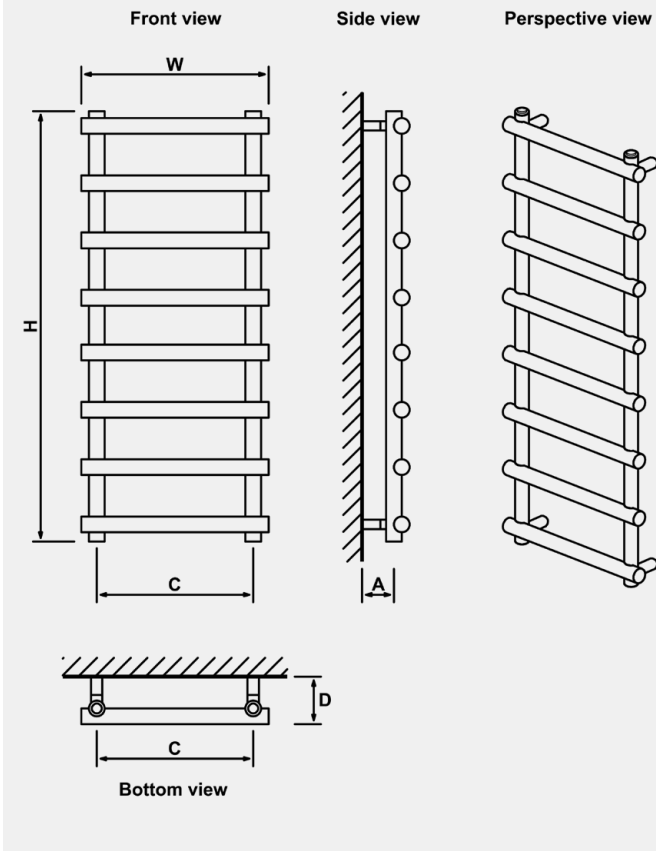

## MARLOW E-STYLE

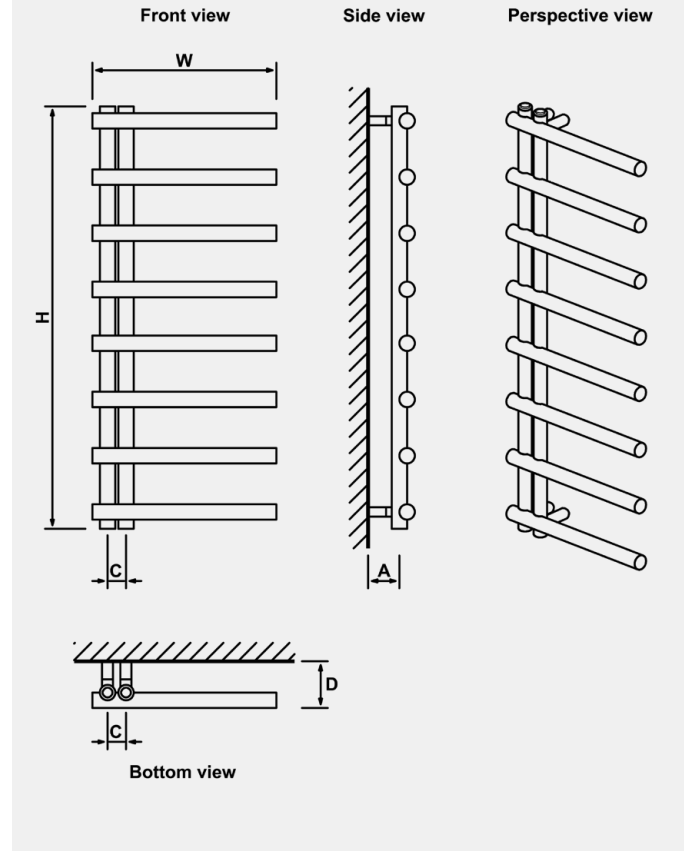

## LAMBOURNE - VERTICAL

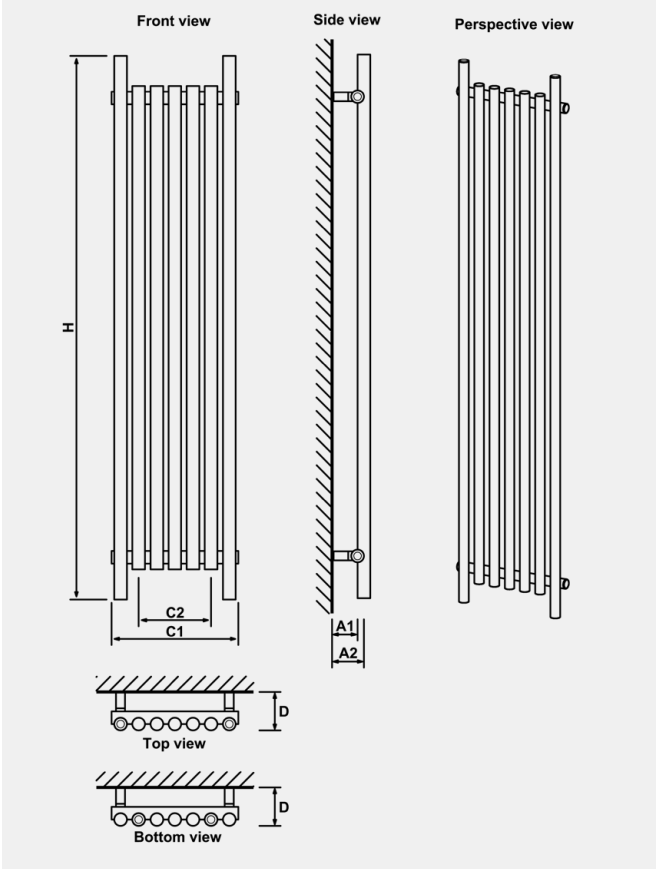

## MURANO - VERTICAL

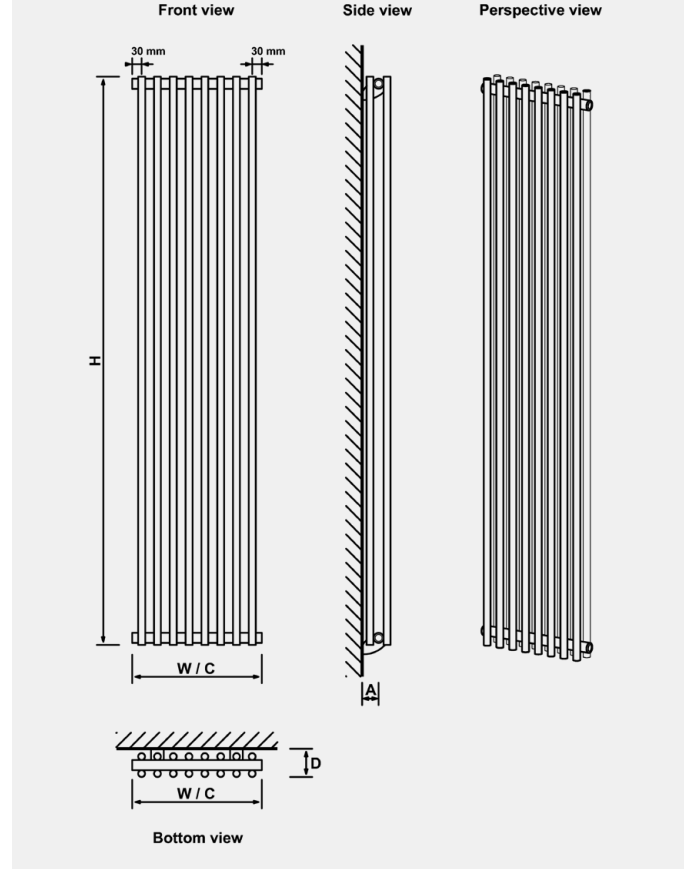

# Technical Tables & Drawings

## MURANO HORIZONTAL - DESIGNER RANGE

Murano - Horizontal																	
Height H (mm)	Width W (mm)	Tappings C (mm)	Distance from wall - D (mm)	Tappings from wall - A (mm)	Tube Qty	Water Content L	Weight KG	Colour	▲T60		Element Output	Element Type	Colour	▲T60		Element Output	Element Type
									Watts	BTU				Watts	BTU		
600	800	755	117	81	20	5.60	10.80	Coloured	864	2948	300W	A, A+, D, F, G	-	-	-	-	-
600	1000	955	117	81	20	6.80	13.50	Coloured	1103	3764	450W	A, A+, D, F, G	-	-	-	-	-
600	1200	1155	117	81	20	8.00	15.90	Coloured	1348	4600	450W	A, A+, D, F, G	-	-	-	-	-
600	1400	1355	117	81	20	9.20	18.10	Coloured	1596	5446	600W	A+, D, F, G	-	-	-	-	-

## RYTON - DESIGNER RANGE

Ryton																	
Height H (mm)	Width W (mm)	Tappings C (mm)	Distance from wall - D (mm)	Tappings from wall - A (mm)	Tube Qty	Water Content L	Weight KG	Colour	▲T60		Element Output	Element Type	Colour	▲T60		Element Output	Element Type
									Watts	BTU				Watts	BTU		
800	500	470	95-110	75-90	6	3.30	4.84	Coloured	253	863	150W	A, A+, D, E, F, G	Chrome	168	572	100W	A, A+, D, E, F, G
800	600	570	95-110	75-90	6	3.70	5.70	Coloured	279	951	150W	A, A+, D, E, F, G	Chrome	185	630	100W	A, A+, D, E, F, G
1200	500	470	95-110	75-90	9	4.50	6.70	Coloured	379	1293	150W	A, A+, D, E, F, G	Chrome	251	856	150W	A, A+, D, E, F, G
1200	600	570	95-110	75-90	9	5.00	7.80	Coloured	418	1425	150W	A, A+, D, E, F, G	Chrome	277	944	150W	A, A+, D, E, F, G
1600	500	470	95-110	75-90	12	5.75	8.60	Coloured	505	1722	300W	A, A+, D, E, F, G	Chrome	334	1141	150W	A, A+, D, E, F, G
1600	600	570	95-110	75-90	12	6.30	9.90	Coloured	556	1898	300W	A, A+, D, E, F, G	Chrome	368	1257	150W	A, A+, D, E, F, G

## KENILWORTH - DESIGNER RANGE

Kenilworth																	
Height H (mm)	Width W (mm)	Tappings C (mm)	Distance from wall - D (mm)	Tappings from wall - A (mm)	Tube Qty	Water Content L	Weight KG	Colour	▲T60		Element Output	Element Type	Colour	▲T60		Element Output	Element Type
									Watts	BTU				Watts	BTU		
800	500	468	92-107	76-91	6	2.50	4.06	Coloured	252	860	150W	A, A+, D, E, F, G	Chrome	167	570	100W	A, A+, D, E, F, G
800	600	568	92-107	76-91	6	2.80	5.30	Coloured	280	956	150W	A, A+, D, E, F, G	Chrome	186	633	100W	A, A+, D, E, F, G
1200	500	468	92-107	75-91	9	3.40	5.60	Coloured	378	1289	150W	A, A+, D, E, F, G	Chrome	250	854	150W	A, A+, D, E, F, G
1200	600	568	92-107	76-91	9	3.85	6.80	Coloured	420	1432	150W	A, A+, D, E, F, G	Chrome	278	948	150W	A, A+, D, E, F, G
1600	500	468	92-107	76-91	12	4.40	7.05	Coloured	503	1717	300W	A, A+, D, E, F, G	Chrome	333	1137	150W	A, A+, D, E, F, G
1600	600	568	92-107	76-91	12	4.90	8.45	Coloured	559	1908	300W	A, A+, D, E, F, G	Chrome	370	1264	150W	A, A+, D, E, F, G

## LOXLEY - DESIGNER RANGE

Loxley																	
Height H (mm)	Width W (mm)	Tappings C (mm)	Distance from wall - D (mm)	Tappings from wall - A (mm)	Tube Qty	Water Content L	Weight KG	Colour	▲T60		Element Output	Element Type	Colour	▲T60		Element Output	Element Type
									Watts	BTU				Watts	BTU		
800	500	441	93	76	6	2.10	3.50	Coloured	194	663	100W	A, A+, D, F, G	Chrome	129	439	N/A	N/A
800	600	541	93	76	6	2.28	5.25	Coloured	216	736	100W	A, A+, D, F, G	Chrome	143	487	N/A	N/A
1200	500	441	93	76	9	3.06	6.00	Coloured	291	993	150W	A, A+, D, E, F, G	Chrome	193	658	100W	A, A+, D, F, G
1200	600	541	93	76	9	3.33	7.30	Coloured	323	1102	150W	A, A+, D, E, F, G	Chrome	214	730	100W	A, A+, D, F, G



Murano Horizontal



Ryton



Kenilworth



Loxley

# Technical Tables & Drawings

## MURANO - HORIZONTAL

Perspective view

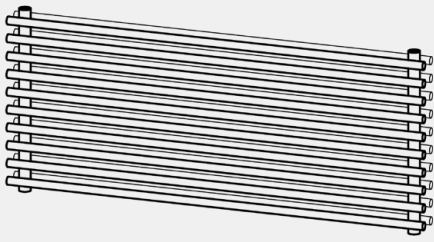

Front view

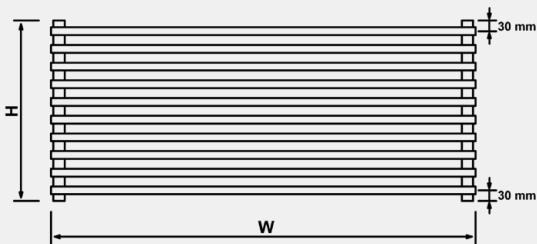

Side view

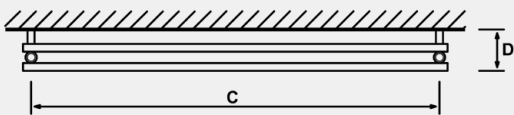

Bottom view

## RYTON

Front view

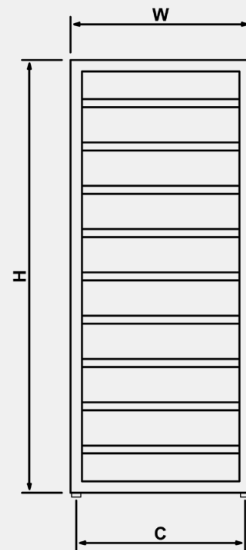

Side view



Perspective view

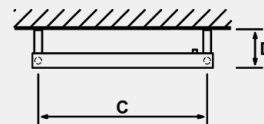
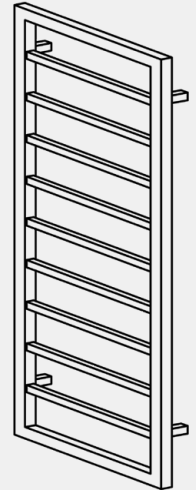

Bottom view

## KENILWORTH

Front view

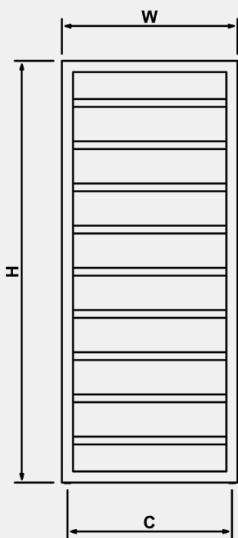

Side view



Perspective view

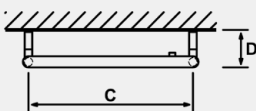
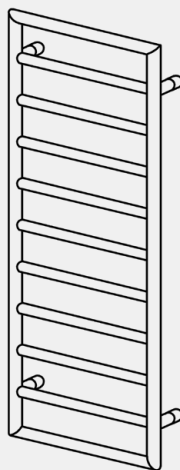

Bottom view

## LOXLEY

Front view

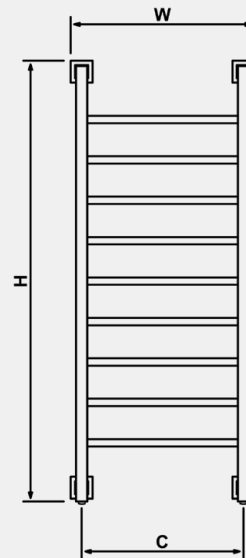

Side view

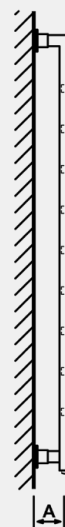

Perspective view

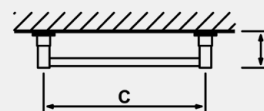
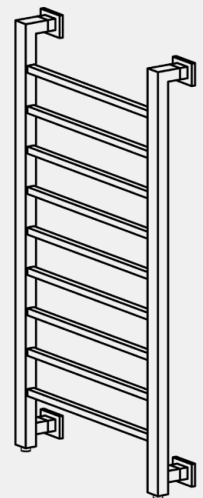

Bottom view

# Technical Tables & Drawings

## ESHTON - DESIGNER RANGE

Eshton																	
Height H (mm)	Width W (mm)	Tappings C (mm)	Distance from wall - D (mm)	Tappings from wall - A (mm)	Tube Qty	Water Content L	Weight KG	Colour	▲T60		Element Output	Element Type	Colour	▲T60		Element Output	Element Type
									Watts	BTU			Watts	BTU			
800	500	441	93	77	6	2.55	4.00	Coloured	248	848	150W	A, A+, D, E, F, G	Chrome	165	561	100W	A, A+, D, F, G
800	600	541	93	77	6	3.11	4.17	Coloured	276	942	150W	A, A+, D, E, F, G	Chrome	183	624	100W	A, A+, D, F, G
1200	500	441	93	77	9	3.45	5.40	Coloured	372	1270	150W	A, A+, D, E, F, G	Chrome	246	841	150W	A, A+, D, E, F, G
1200	600	541	93	77	9	3.72	5.80	Coloured	413	1411	150W	A, A+, D, E, F, G	Chrome	274	934	150W	A, A+, D, E, F, G

## RUBANO - VERTICAL - DESIGNER RANGE

Rubano - Vertical													
Height H (mm)	Width W (mm)	Tappings C (mm)	Distance from wall - D (mm)	Tappings from wall - A (mm)	Tube Qty	Water Content L	Weight KG	Colour	▲T60		Element Output	Element Type	
									Watts	BTU			
1800	383	383	114	74	6	18.10	35.70	Coloured	1658	5654	300W	A, A+, C*, H*	
1800	503	503	114	74	8	24.10	47.20	Coloured	2210	7536	600W	A+, C**, H**	

\* Element Type C and H 300W can be used \*\* Element Type C and H 900w can be used

## RUBANO - HORIZONTAL - DESIGNER RANGE

Rubano - Horizontal													
Height H (mm)	Width W (mm)	Tappings C (mm)	Distance from wall - D (mm)	Tappings from wall - A (mm)	Tube Qty	Water Content L	Weight KG	Colour	▲T60		Element Output	Element Type	
									Watts	BTU			
600	383	383	114	74	6	7.10	11.20	Coloured	553	1886	300W	A, A+, C*, H*	
600	623	623	114	74	10	11.70	18.10	Coloured	921	3141	450W	A, A+, C, E**, H	
600	803	803	114	74	13	15.20	23.50	Coloured	1197	4082	600W	A, A+, C, E, H	
600	1103	1103	114	74	18	21.10	33.30	Coloured	1658	5654	900W	A, A+, C, H	

\* Element Type C and H only 300W can be used \*\* Element Type E only 300E can be used

## ROWSHAM - DESIGNER RANGE

Rowsham - Horizontal																	
Height H (mm)	Width W (mm)	Tappings C (mm)	Distance from wall - D (mm)	Tappings from wall - A (mm)	Tube Qty	Water Content L	Weight KG	Colour	▲T60		Element Output	Element Type	Colour	▲T60		Element Output	Element Type
									Watts	BTU			Watts	BTU			
600	580	580	110	54	15	7.03	12.0	Coloured	636	2171	N/A	N/A	-	-	-	-	-
600	780	780	110	54	20	9.39	15.0	Coloured	884	3017	N/A	N/A	-	-	-	-	-
600	980	980	110	54	25	11.74	19.0	Coloured	1140	3890	N/A	N/A	-	-	-	-	-
600	1180	1180	110	54	30	14.09	23.0	Coloured	1401	4781	N/A	N/A	-	-	-	-	-

Rowsham - Vertical																	
Height H (mm)	Width W (mm)	Tappings C (mm)	Distance from wall - D (mm)	Tappings from wall - A (mm)	Tube Qty	Water Content L	Weight KG	Colour	▲T60		Element Output	Element Type	Colour	▲T60		Element Output	Element Type
									Watts	BTU			Watts	BTU			
1800	300	300	110	54	8	10.30	16.0	Coloured	1045	3566	N/A	N/A	-	-	-	-	-
1800	380	380	110	54	10	12.89	19.0	Coloured	1360	4641	N/A	N/A	-	-	-	-	-
1800	500	500	110	54	13	16.76	25.0	Coloured	1846	6299	N/A	N/A	-	-	-	-	-



Eshton



Rubano Vertical



Rubano Horizontal



Rowsham Horizontal



Rowsham Vertical

# Technical Tables & Drawings

## ESHTON

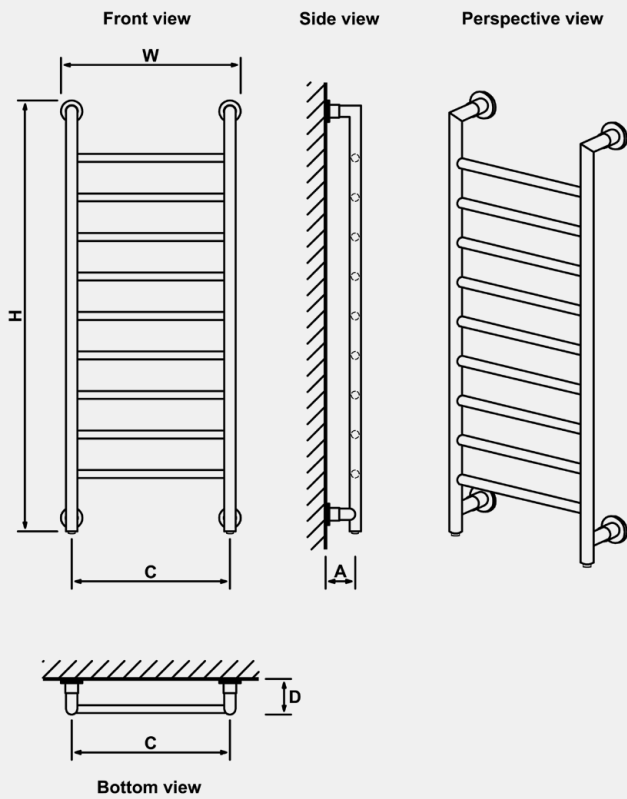

## RUBANO - VERTICAL

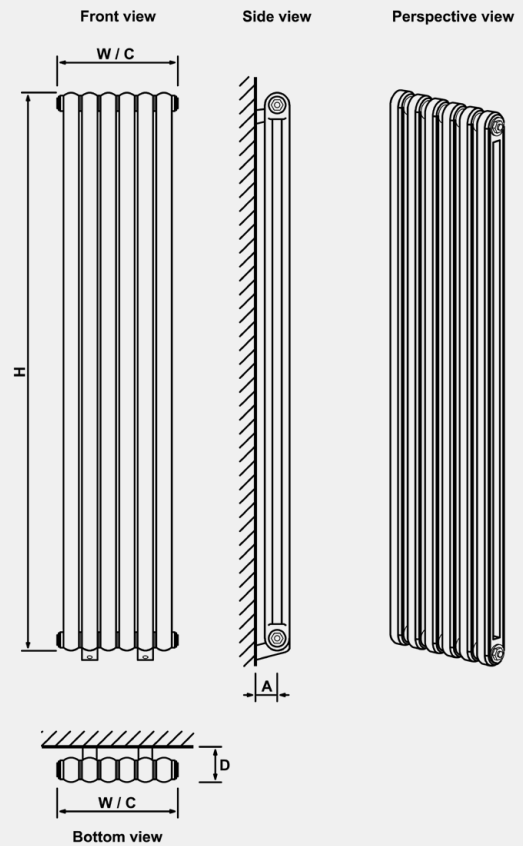

## RUBANO - HORIZONTAL

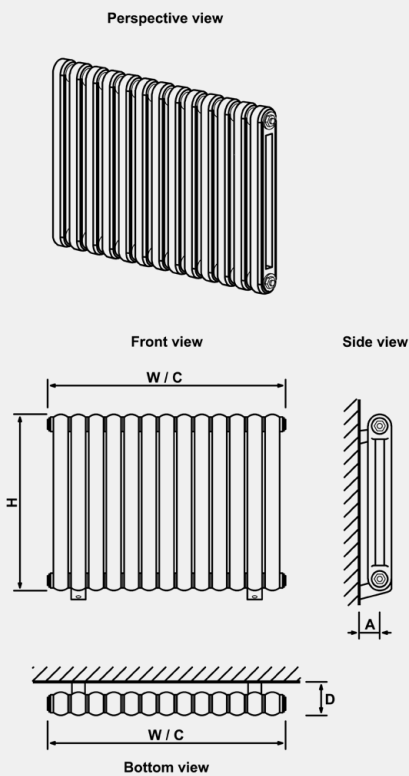

## ROWSHAM - HORIZONTAL

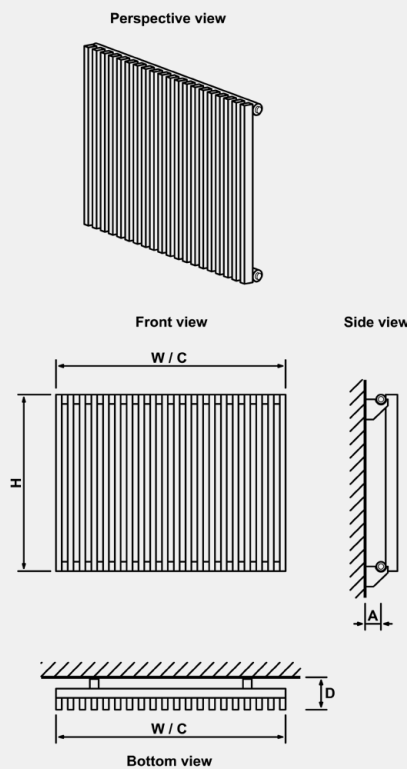

## ROWSHAM - VERTICAL

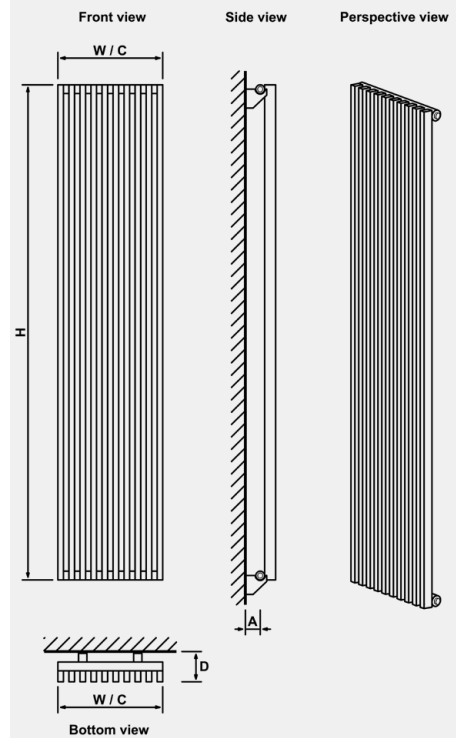

# Technical Tables & Drawings

## ROWSHAM TOWEL RAIL - DESIGNER RANGE

Rowsham Towel Rail																	
Height H (mm)	Width W (mm)	Tappings C (mm)	Distance from wall - D (mm)	Tappings from wall - A (mm)	Tube Qty	Water Content L	Weight KG	Colour	▲T60		Element Output	Element Type	Colour	▲T60		Element Output	Element Type
									Watts	BTU				Watts	BTU		
800	500	468	139	83	13	5.50	8.50	Coloured	581	1983	300W	A, A+, D, E, F, G	-	-	-	-	-
800	600	568	139	83	13	6.40	9.60	Coloured	627	2140	300W	A, A+, D, E, F, G	-	-	-	-	-
1200	500	468	139	83	22	9.10	14.00	Coloured	869	2966	450W	A, A+, D, E, F, G	-	-	-	-	-
1200	600	568	139	83	22	10.60	15.50	Coloured	938	3201	600W	A, A+, D, E, F, G	-	-	-	-	-
1800	500	468	139	83	30	12.60	19.40	Coloured	1331	4542	600W	A, A+, D, E, F, G	-	-	-	-	-
1800	600	568	139	83	30	14.70	21.60	Coloured	1437	4904	750W	A, A+, D, E, F, G	-	-	-	-	-

## TUNSTALL - DESIGNER RANGE

Tunstall - Vertical																	
Height H (mm)	Width W (mm)	Tappings C (mm)	Distance from wall - D (mm)	Tappings from wall - A (mm)	Tube Qty	Water Content L	Weight KG	Colour	▲T60		Element Output	Element Type	Colour	▲T60		Element Output	Element Type
									Watts	BTU				Watts	BTU		
1800	280	280	93	52	4	6.08	10.7	Coloured	583	1990	N/A	N/A	Chrome	320	1092	N/A	N/A
1800	350	350	93	52	5	8.07	12.72	Coloured	750	2559	N/A	N/A	Chrome	423	1444	N/A	N/A
1800	420	420	93	52	6	9.14	15.4	Coloured	926	3160	N/A	N/A	Chrome	533	1819	N/A	N/A
1800	490	490	93	52	7	11.29	17.30	Coloured	1099	3750	N/A	N/A	Chrome	644	2198	N/A	N/A
1800	560	560	93	52	8	12.91	19.50	Coloured	1280	4368	N/A	N/A	Chrome	760	2594	N/A	N/A
1800	630	630	93	52	9	13.73	22.5	Coloured	1471	5020	N/A	N/A	Chrome	890	3037	N/A	N/A

Tunstall - Horizontal																	
Height H (mm)	Width W (mm)	Tappings C (mm)	Distance from wall - D (mm)	Tappings from wall - A (mm)	Tube Qty	Water Content L	Weight KG	Colour	▲T60		Element Output	Element Type	Colour	▲T60		Element Output	Element Type
									Watts	BTU				Watts	BTU		
600	471	471	93	52	8	4.68	8.10	Coloured	399	1362	N/A	N/A	-	-	-	-	-
600	589	589	93	52	10	5.37	10.3	Coloured	509	1737	N/A	N/A	-	-	-	-	-
600	648	648	93	52	11	6.43	10.80	Coloured	565	1928	N/A	N/A	-	-	-	-	-
600	825	825	93	52	14	7.53	13.8	Coloured	742	2532	N/A	N/A	-	-	-	-	-
600	1002	1002	93	52	17	9.15	16.5	Coloured	928	3167	N/A	N/A	-	-	-	-	-
600	1061	1061	93	52	18	10.53	16.93	Coloured	1003	3423	N/A	N/A	-	-	-	-	-
600	1179	1179	93	52	20	10.77	19.2	Coloured	1123	3832	N/A	N/A	-	-	-	-	-

Tunstall Towel Rail																	
Height H (mm)	Width W (mm)	Tappings C (mm)	Distance from wall - D (mm)	Tappings from wall - A (mm)	Tube Qty	Water Content L	Weight KG	Colour	▲T60		Element Output	Element Type	Colour	▲T60		Element Output	Element Type
									Watts	BTU				Watts	BTU		
560	1000	954	124	83	8	4.72	12.3	Coloured	690	2355	300W	A, A+, D, E, F, G	Chrome	431	1471	150W	A, A+, D, E, F, G
800	500	454	124	83	9	4.45	8.9	Coloured	454	1550	150W	A, A+, D, E, F, G	Chrome	284	970	150W	A, A+, D, E, F, G
800	600	554	124	83	9	5.18	10.1	Coloured	524	1788	300W	A, A+, D, E, F, G	Chrome	326	1113	150W	A, A+, D, E, F, G
1200	500	454	124	83	13	6.51	12.6	Coloured	663	2263	300W	A, A+, D, E, F, G	Chrome	431	1471	150W	A, A+, D, E, F, G
1200	600	554	124	83	13	7.56	14.3	Coloured	766	2614	450W	A, A+, D, E, F, G	Chrome	493	1683	300W	A, A+, D, E, F, G
1600	500	454	124	83	17	8.56	16.4	Coloured	879	3000	450W	A, A+, D, E, F, G	Chrome	579	1976	300W	A, A+, D, E, F, G
1600	600	554	124	83	17	9.94	18.6	Coloured	1015	3464	600W	A, A+, D, E, F, G	Chrome	661	2256	300W	A, A+, D, E, F, G

Tunstall Double - Vertical																	
Height H (mm)	Width W (mm)	Tappings C (mm)	Distance from wall - D (mm)	Tappings from wall - A (mm)	Tube Qty	Water Content L	Weight KG	Colour	▲T60		Element Output	Element Type	Colour	▲T60		Element Output	Element Type
									Watts	BTU				Watts	BTU		
1800	280	280	104	65	8	16.9	25.90	Coloured	952	3249	N/A	N/A	-	-	-	-	-
1800	350	350	104	65	10	14.50	30.10	Coloured	1190	4058	N/A	N/A	-	-	-	-	-
1800	420	420	104	65	12	25.3	35.80	Coloured	1429	4877	N/A	N/A	-	-	-	-	-
1800	490	490	104	65	14	20.20	41.10	Coloured	1666	5681	N/A	N/A	-	-	-	-	-
1800	560	560	104	65	16	23.10	47.10	Coloured	1904	6493	N/A	N/A	-	-	-	-	-
1800	630	630	104	65	18	38	51.00	Coloured	2142	7311	N/A	N/A	-	-	-	-	-



Rowsham Towel Rail



Tunstall Vertical



Tunstall Horizontal



Tunstall Towel Rail



Tunstall Double Vertical

# Technical Tables & Drawings

## ROWSHAM TOWEL RAIL

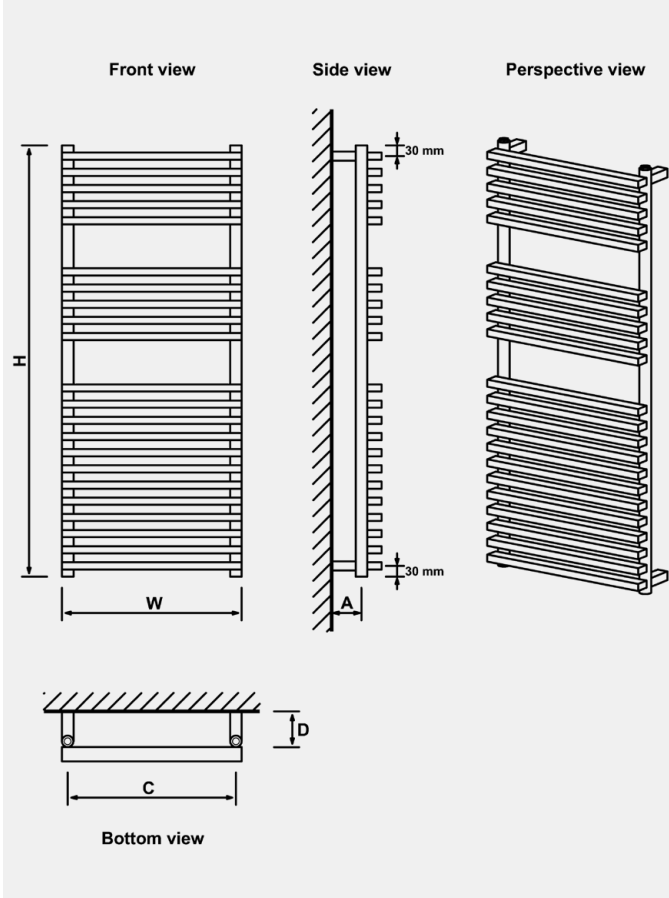

## TUNSTALL TOWEL RAIL

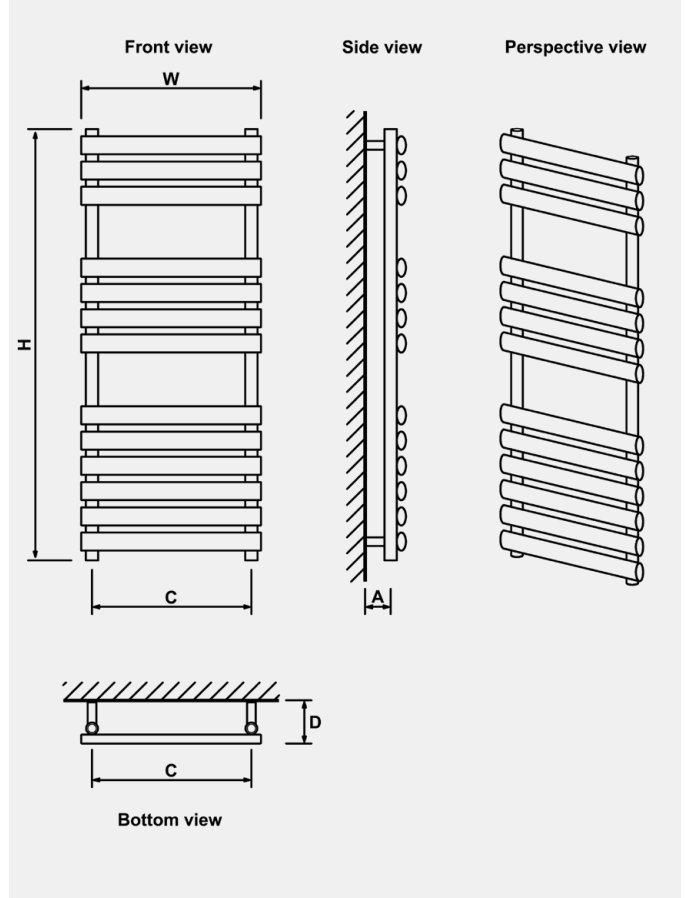

## TUNSTALL - VERTICAL

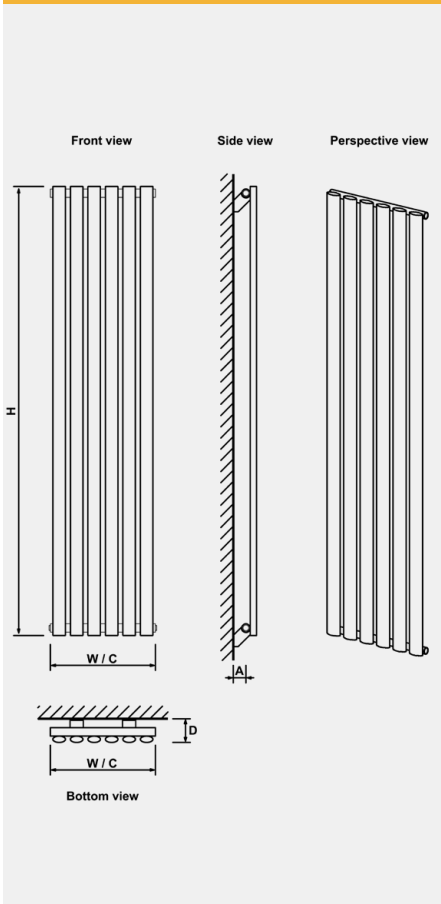

## TUNSTALL - HORIZONTAL

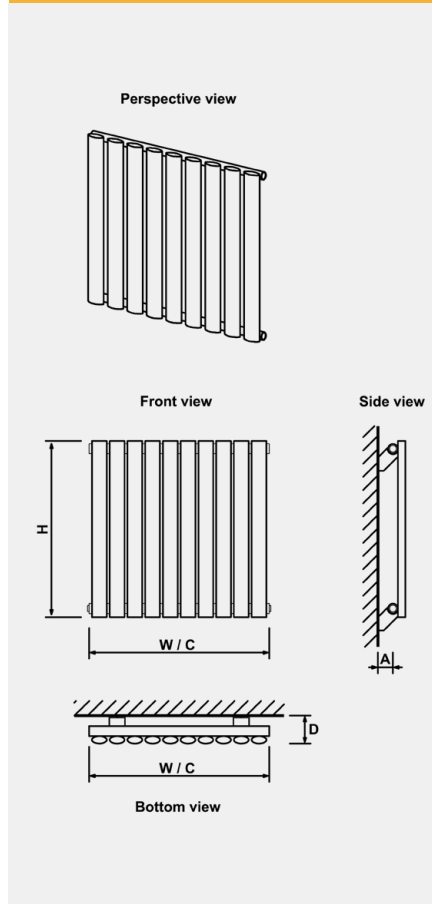

## TUNSTALL DOUBLE VERTICAL

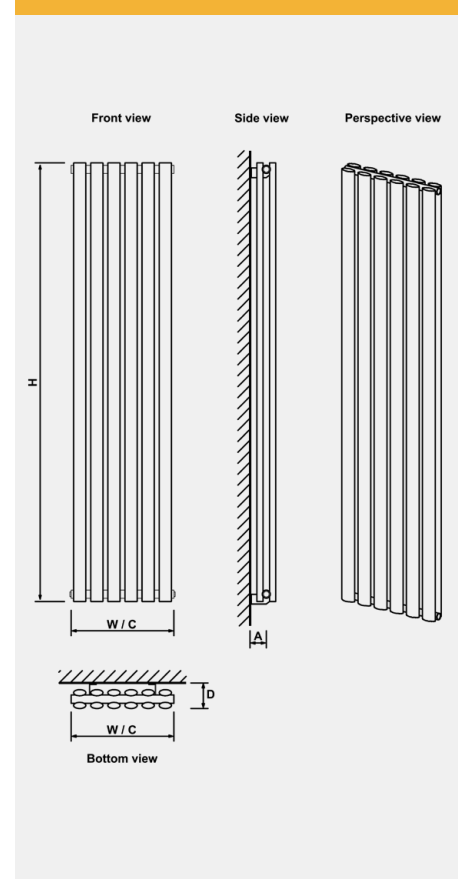

# Technical Tables & Drawings

## TUNSTALL - DESIGNER RANGE

### Tunstall Double - Horizontal

Height H (mm)	Width W (mm)	Tappings C (mm)	Distance from wall - D (mm)	Tappings from wall - A (mm)	Tube Qty	Water Content L	Weight KG	Colour	▲T60		Element Output	Element Type	Colour	▲T60		Element Output	Element Type
									Watts	BTU				Watts	BTU		
600	471	471	104	65	16	8.10	17.20	Coloured	734	2503	N/A	N/A	-	-	-	-	-
600	589	589	104	65	20	14.6	21.80	Coloured	818	2792	N/A	N/A	-	-	-	-	-
600	648	648	104	65	22	11.10	23.70	Coloured	1010	3444	N/A	N/A	-	-	-	-	-
600	825	825	104	65	28	20.5	29.50	Coloured	1145	3908	N/A	N/A	-	-	-	-	-
600	1002	1002	104	65	34	24.8	36.60	Coloured	1391	4747	N/A	N/A	-	-	-	-	-
600	1061	1061	104	65	36	18.30	38.60	Coloured	1652	5633	N/A	N/A	-	-	-	-	-
600	1179	1179	104	65	40	29.2	43.60	Coloured	1836	6266	N/A	N/A	-	-	-	-	-

### Tunstall Double Towel Rail

Height H (mm)	Width W (mm)	Tappings C (mm)	Distance from wall - D (mm)	Tappings from wall - A (mm)	Tube Qty	Water Content L	Weight KG	Colour	▲T60		Element Output	Element Type	Colour	▲T60		Element Output	Element Type
									Watts	BTU				Watts	BTU		
560	1000	954	109-114	70-75	16	19.1	27.90	Coloured	1060	3618	600W	A, A+, D, E, F, G	-	-	-	-	-
800	500	454	109-114	70-75	18	11.5	20.80	Coloured	620	2116	300W	A, A+, D, E, F, G	-	-	-	-	-
800	600	554	109-114	70-75	18	13.5	21.80	Coloured	742	2532	450W	A, A+, D, E, F, G	-	-	-	-	-
1200	500	454	109-114	70-75	26	16.7	29.10	Coloured	893	3048	450W	A, A+, D, E, F, G	-	-	-	-	-
1200	600	554	109-114	70-75	26	19.6	30.20	Coloured	1072	3659	600W	A, A+, D, E, F, G	-	-	-	-	-
1600	500	454	109-114	70-75	34	21.9	36.90	Coloured	1170	3993	600W	A, A+, D, E, F, G	-	-	-	-	-
1600	600	554	109-114	70-75	34	25.8	37.90	Coloured	1405	4795	750W	A, A+, D, E, F, G	-	-	-	-	-

### Tunstall Mirror

Height H (mm)	Width W (mm)	Tappings C (mm)	Distance from wall - D (mm)	Tappings from wall - A (mm)	Tube Qty	Water Content L	Weight KG	Colour	▲T60		Element Output	Element Type	Colour	▲T60		Element Output	Element Type
									Watts	BTU				Watts	BTU		
1800	380	380	79	40	4	8.6	23.70	Coloured	705	2406	N/A	N/A	-	-	-	-	-
1800	500	500	79	40	6	12.9	28.30	Coloured	1056	3604	N/A	N/A	-	-	-	-	-

### Tunstall Double Mirror

Height H (mm)	Width W (mm)	Tappings C (mm)	Distance from wall - D (mm)	Tappings from wall - A (mm)	Tube Qty	Water Content L	Weight KG	Colour	▲T60		Element Output	Element Type	Colour	▲T60		Element Output	Element Type
									Watts	BTU				Watts	BTU		
1800	380	380	104	65	8	16.9	33.70	Coloured	1102	3761	N/A	N/A	-	-	-	-	-
1800	500	500	104	65	12	25.3	44.10	Coloured	1654	5645	N/A	N/A	-	-	-	-	-

## DEDDINGTON - DESIGNER RANGE

### Deddington - Vertical

Height H (mm)	Width W (mm)	Tappings C (mm)	Distance from wall - D (mm)	Tappings from wall - A (mm)	Tube Qty	Water Content L	Weight KG	Colour	▲T60		Element Output	Element Type	Colour	▲T60		Element Output	Element Type
									Watts	BTU				Watts	BTU		
1800	310	310	100	60	4	4.20	15.3	Coloured	812	2771	N/A	N/A	Chrome	493	1683	N/A	N/A
1800	390	390	100	60	5	5.20	17.80	Coloured	1021	3484	N/A	N/A	Chrome	611	2085	N/A	N/A
1800	470	470	100	60	6	6.30	22.4	Coloured	1231	4201	N/A	N/A	Chrome	730	2491	N/A	N/A
1800	550	550	100	60	7	7.30	24.90	Coloured	1440	4914	N/A	N/A	Chrome	846	2887	N/A	N/A
1800	630	630	100	60	8	8.40	29.6	Coloured	1649	5627	N/A	N/A	Chrome	962	3283	N/A	N/A



Tunstall Double  
Horizontal



Tunstall Double Towel Rail



Tunstall Mirror



Tunstall Double Mirror



Deddington  
Vertical



# Technical Tables & Drawings

## TUNSTALL DOUBLE HORIZONTAL

Perspective view

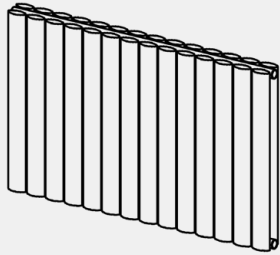

Front view

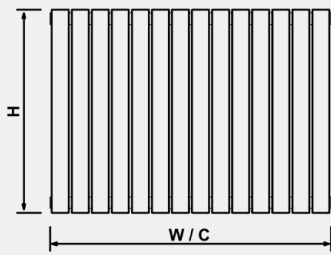

Side view

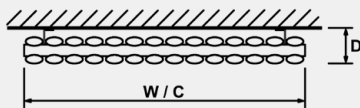

Bottom view

## TUNSTALL DOUBLE TOWEL RAIL

Front view

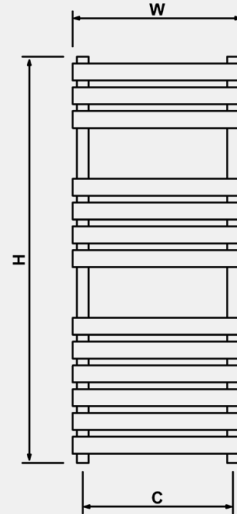

Side view



Perspective view

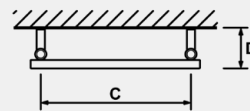
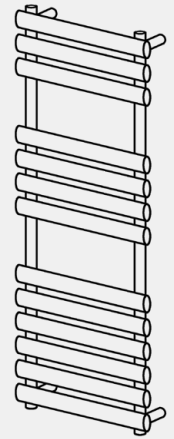

Bottom view

## TUNSTALL MIRROR

Front view

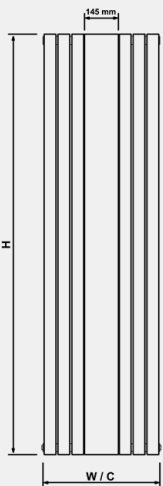

Side view

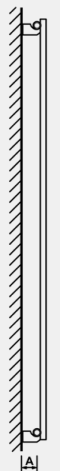

Perspective view

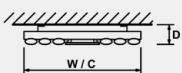
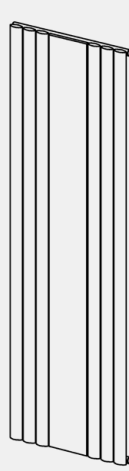

Bottom view

## TUNSTALL DOUBLE MIRROR

Front view

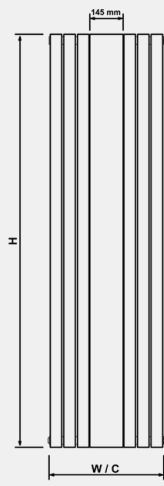

Side view

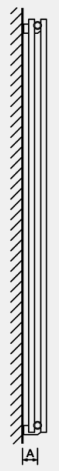

Perspective view

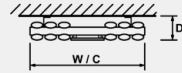
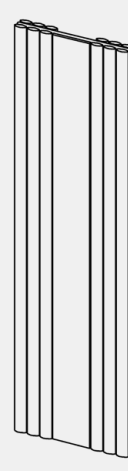

Bottom view

## DEDDINGTON VERTICAL

Front view

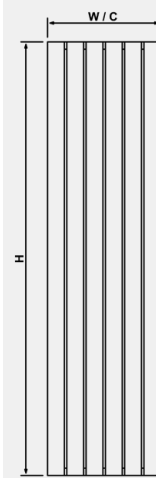

Side view



Perspective view

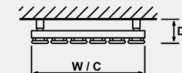
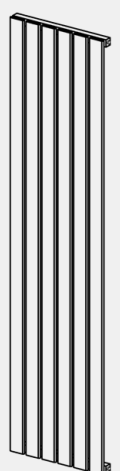

Bottom view

# Technical Tables & Drawings

## DEDDINGTON - DESIGNER RANGE

### Deddington - Horizontal

Height H (mm)	Width W (mm)	Tappings C (mm)	Distance from wall - D (mm)	Tappings from wall - A (mm)	Tube Qty	Water Content L	Weight KG	Colour	▲T60		Element Output	Element Type	Colour	▲T60		Element Output	Element Type
									Watts	BTU				Watts	BTU		
600	390	390	100	60	5	2.10	6.70	Coloured	373	1273	N/A	N/A	Chrome	249	850	N/A	N/A
600	470	470	100	60	6	2.50	8.00	Coloured	449	1532	N/A	N/A	Chrome	296	1010	N/A	N/A
600	550	550	100	60	7	2.90	9.40	Coloured	525	1792	N/A	N/A	Chrome	343	1171	N/A	N/A
600	630	630	100	60	8	3.40	11.9	Coloured	602	2055	N/A	N/A	Chrome	390	1331	N/A	N/A
600	790	790	100	60	10	4.30	14.7	Coloured	754	2573	N/A	N/A	Chrome	483	1648	N/A	N/A
600	950	950	100	60	12	5.10	17.6	Coloured	907	3095	N/A	N/A	Chrome	574	1959	N/A	N/A
600	1110	1110	100	60	14	6.00	18.80	Coloured	1059	3614	N/A	N/A	Chrome	664	2266	N/A	N/A
600	1270	1270	100	60	16	6.90	23.5	Coloured	1212	4136	N/A	N/A	Chrome	755	2577	N/A	N/A

### Deddington Towel Rails

Height H (mm)	Width W (mm)	Tappings C (mm)	Distance from wall - D (mm)	Tappings from wall - A (mm)	Tube Qty	Water Content L	Weight KG	Colour	▲T60		Element Output	Element Type	Colour	▲T60		Element Output	Element Type
									Watts	BTU				Watts	BTU		
800	500	470	100	60	8	3.30	11	Coloured	509	1737	150W	A, A+, D, E, F, G	Chrome	320	1092	150W	A, A+, D, E, F, G
800	600	570	100	60	8	3.70	12.4	Coloured	591	2017	300W	A, A+, D, E, F, G	Chrome	368	1256	150W	A, A+, D, E, F, G
1200	500	470	100	60	11	4.60	15.1	Coloured	725	2474	300W	A, A+, D, E, F, G	Chrome	457	1560	300W	A, A+, D, E, F, G
1200	600	570	100	60	11	5.20	17.3	Coloured	843	2877	300W	A, A+, D, E, F, G	Chrome	525	1792	300W	A, A+, D, E, F, G
1800	500	470	100	60	15	6.50	20.6	Coloured	1031	3518	450W	A, A+, D, E, F, G	Chrome	646	2205	300W	A, A+, D, E, F, G
1800	600	570	100	60	15	7.30	23.6	Coloured	1199	4091	450W	A, A+, D, E, F, G	Chrome	743	2536	450W	A, A+, D, E, F, G

## ADDINGTON - DESIGNER RANGE

### Addington Type 10 - Vertical / Horizontal

Height H (mm)	Width W (mm)	Vertical Installation Tappings C1 (mm)	Horizontal Installation Tappings C2 (mm)	Distance from wall - D (mm)	Tappings from wall - A (mm)	Tube Qty	Water Content L	Weight KG	Colour	▲T60		Element Output	Element Type
										Watts	BTU		
500	514	514	450	69	40	7	2.63	6.95	Coloured	414	1413	150W	A, A+, C, E, H
500	588	588	450	69	40	8	3.00	7.93	Coloured	473	1614	300W	A, A+, C, E, H
600	292	292	550	69	40	4	1.70	4.60	Coloured	281	958	150W	A, A+
600	366	366	550	69	40	5	2.10	5.80	Coloured	351	1198	150W	A, A+
600	440	440	550	69	40	6	2.50	6.90	Coloured	421	1438	150W	A, A+, C, E, H
600	514	514	550	69	40	7	2.97	8.04	Coloured	492	1679	300W	A, A+, C, E, H
600	588	588	550	69	40	8	3.40	9.18	Coloured	562	1918	300W	A, A+, C, E, H
600	662	662	550	69	40	9	3.80	10.30	Coloured	632	2157	300W	A, A+, C, E, H
600	810	810	550	69	40	11	4.70	12.60	Coloured	772	2636	450W	A+, C, E, H
600	1032	1032	550	69	40	14	6.00	16.00	Coloured	983	3355	600W	A, A+, C, E, H
600	1180	1180	550	69	40	16	6.80	18.30	Coloured	1124	3834	600W	A, A+, C, E, H
600	1254	1254	550	69	40	17	7.20	19.40	Coloured	1194	4073	600W	A, A+, C, E, H
800	514	514	750	69	40	7	3.67	10.22	Coloured	642	2191	300W	A, A+, C, H
800	588	588	750	69	40	8	4.19	11.67	Coloured	733	2501	450W	A, A+, C, H
1000	514	514	950	69	40	7	4.36	12.41	Coloured	786	2682	450W	A, A+, C, H
1000	588	588	950	69	40	8	4.99	14.17	Coloured	898	3064	450W	A, A+, C, H
1200	514	514	1150	69	40	7	5.06	14.59	Coloured	923	3149	450W	A, A+, C, H
1200	588	588	1150	69	40	8	5.78	16.66	Coloured	1055	3600	600W	A+, C, H
1400	514	514	1350	69	40	7	5.75	16.78	Coloured	1055	3600	600W	A+, C, H
1400	588	588	1350	69	40	8	6.57	19.16	Coloured	1206	4115	600W	A+, C, H
1800	292	292	1750	69	40	4	4.08	12.12	Coloured	744	2539	N/A	N/A
1800	366	366	1750	69	40	5	5.10	15.13	Coloured	931	3177	N/A	N/A
1800	440	440	1750	69	40	6	6.12	18.14	Coloured	1117	3811	450W	A, A+
1800	514	514	1750	69	40	7	7.14	21.14	Coloured	1303	4446	600W	A+
1800	588	588	1750	69	40	8	8.16	24.15	Coloured	1489	5080	600W	A+

\*In horizontal installation, the above Heights become Widths and above Widths become Heights



Deddington  
Horizontal



Deddington  
Towel Rail



Addington Type 10  
Vertical / Horizontal

# Technical Tables & Drawings

**DEDDINGTON  
HORIZONTAL**

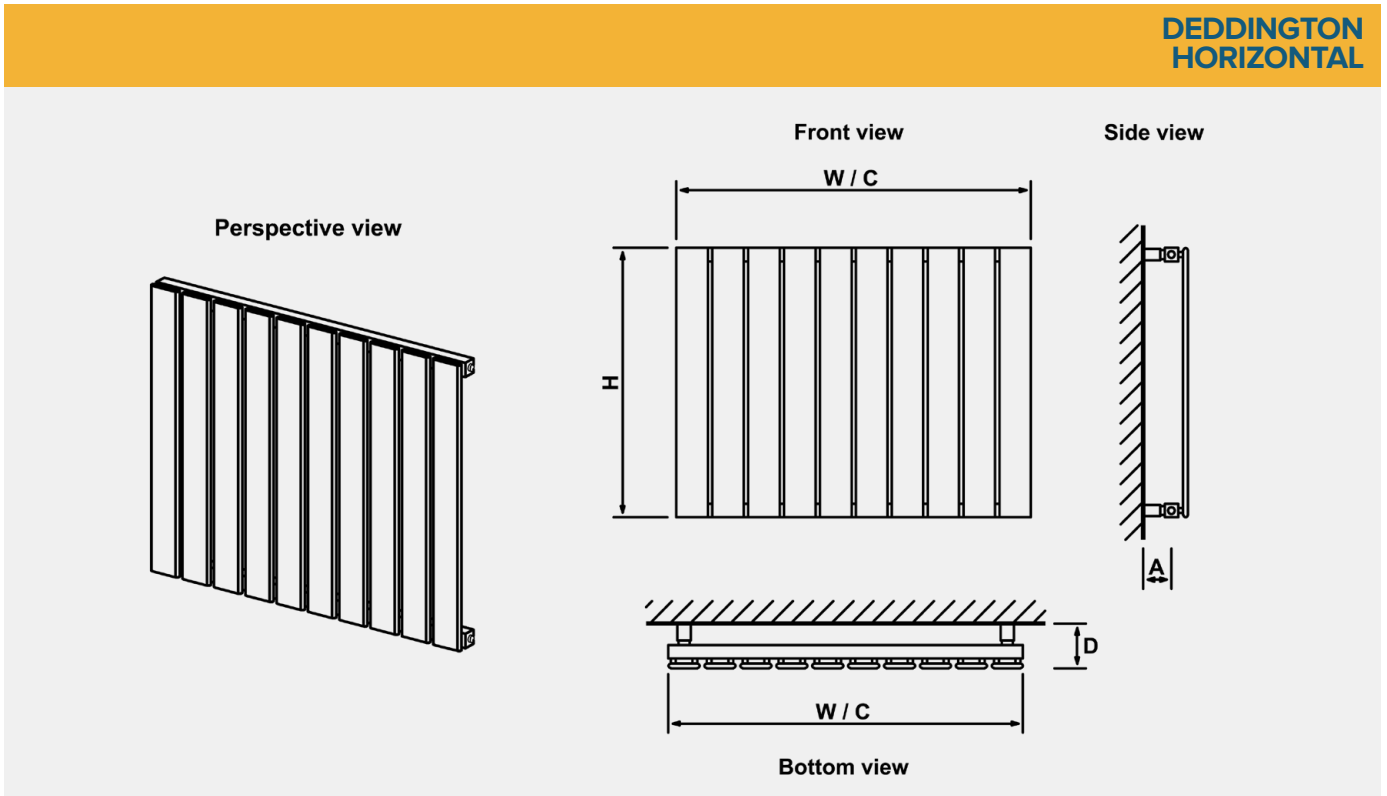

**DEDDINGTON  
TOWEL RAIL**

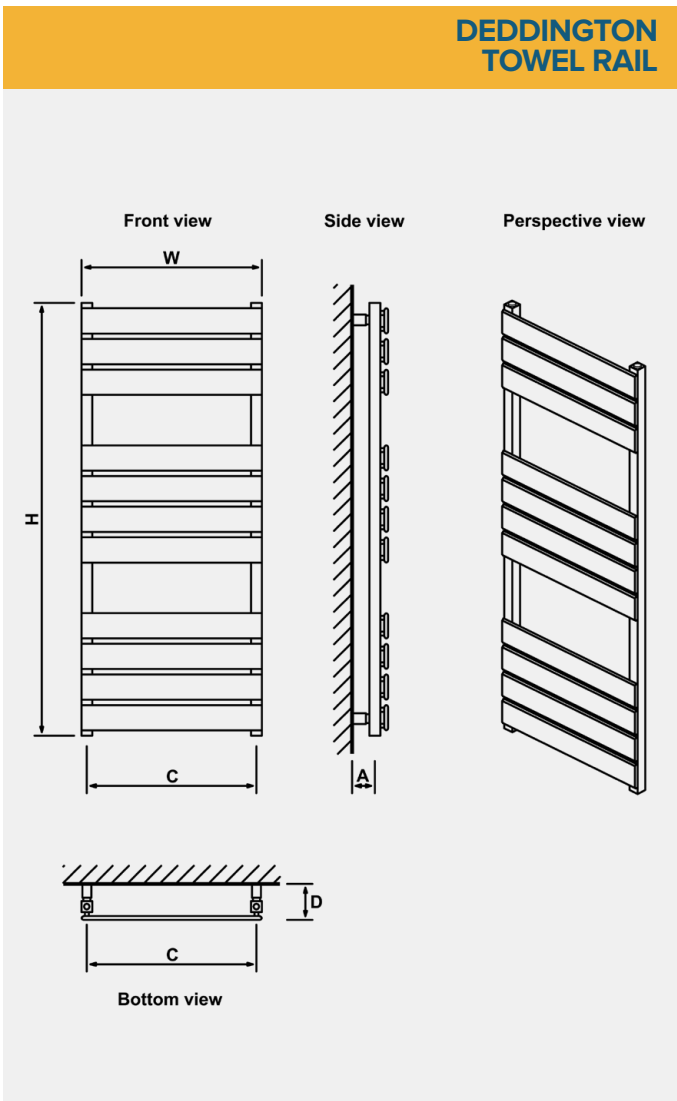

**ADDINGTON TYPE 10  
VERTICAL / HORIZONTAL**

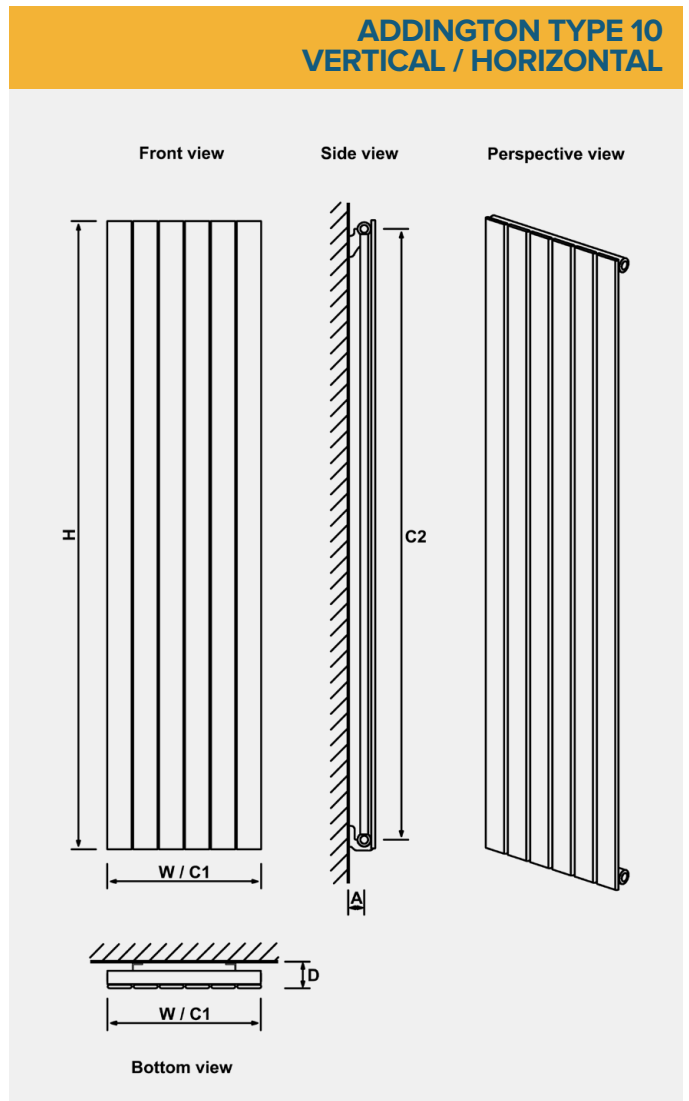

# Technical Tables & Drawings

## ADDINGTON - DESIGNER RANGE

### Addington Type 20 - Vertical / Horizontal

Height H (mm)	Width W (mm)	Vertical Installation Tappings C1 (mm)	Horizontal Installation Tappings C2 (mm)	Distance from wall - D (mm)	Tappings from wall - A (mm)	Tube Qty	Water Content L	Weight KG	Colour	▲T60		Element Output	Element Type
										Watts	BTU		
600	292	292	550	93	64	8	2.9	8.4	Coloured	401	1369	150W	A,A+
600	366	366	550	93	64	10	3.7	10.4	Coloured	502	1712	300W	A,A+
600	440	440	550	93	64	12	4.4	12.5	Coloured	602	2054	300W	A,A+,C,H
600	514	514	550	93	64	14	5.2	14.6	Coloured	702	2396	300W	A,A+,C,H
600	588	588	550	93	64	16	5.9	16.7	Coloured	803	2738	450W	A,A+,C,H
600	662	662	550	93	64	18	6.6	18.7	Coloured	903	3081	450W	A,A+,C,H
600	810	810	550	93	64	22	8.1	22.9	Coloured	1104	3765	600W	A,A+,C,E,H
600	1032	1032	550	93	64	28	10.3	29.1	Coloured	1405	4792	750W	A,A+,C,E,H
600	1180	1180	550	93	64	32	11.8	33.2	Coloured	1605	5477	900W	A,A+,C,E,H
600	1254	1254	550	93	64	34	12.5	35.3	Coloured	1706	5819	1000W	A,A+,C,E,H
1800	366	366	1750	93	64	10	9.63	29.17	Coloured	1329	4535	300W	A,A+
1800	440	440	1750	93	64	12	11.56	34.98	Coloured	1595	5442	450W	A,A+
1800	514	514	1750	93	64	14	13.49	40.80	Coloured	1861	6350	600W	A+
1800	588	588	1750	93	64	16	15.41	46.62	Coloured	2127	7257	600W	A+

\*In horizontal installation, the above Heights become Widths and above Widths become Heights

### Addington Type 10 Towel Rail

Height H (mm)	Width W (mm)	Tappings C (mm)	Distance from wall - D (mm)	Tappings from wall - A (mm)	Tube Qty	Water Content L	Weight KG	Colour	▲T60		Element Output	Element Type	▲T60		Element Output	Element Type
									Watts	BTU			Watts	BTU		
790	400	350	69	40	8	3.20	8.50	Coloured	374	1276	150W	A, A+, D, E, F, G	-	-	-	-
790	500	450	69	40	8	3.60	10.00	Coloured	467	1593	150W	A, A+, D, E, F, G	-	-	-	-
790	600	550	69	40	8	4.00	11.30	Coloured	560	1911	300W	A, A+, D, E, F, G	-	-	-	-
1110	400	350	69	40	10	4.20	11.00	Coloured	492	1679	300W	A, A+, D, E, F, G	-	-	-	-
1110	500	450	69	40	10	4.70	12.75	Coloured	610	2081	300W	A, A+, D, E, F, G	-	-	-	-
1110	600	550	69	40	10	5.30	14.50	Coloured	731	2494	450W	A, A+, D, E, F, G	-	-	-	-
1750	400	350	69	40	14	6.30	16.00	Coloured	729	2487	450W	A, A+, D, E, F, G	-	-	-	-
1750	500	450	69	40	14	7.00	18.50	Coloured	885	3020	450W	A, A+, D, E, F, G	-	-	-	-
1750	600	550	69	40	14	7.70	21.00	Coloured	1062	3624	600W	A, A+, D, E, F, G	-	-	-	-

### Addington Type 20 Towel Rail

Height H (mm)	Width W (mm)	Tappings C (mm)	Distance from wall - D (mm)	Tappings from wall - A (mm)	Tube Qty	Water Content L	Weight KG	Colour	▲T60		Element Output	Element Type
									Watts	BTU		
1110	500	450	93	64	20	4.70	16.75	Coloured	826	2817	450W	A, A+, D, E, F, G
1750	500	450	93	64	28	10.60	29.70	Coloured	1163	3966	600W	A, A+, D, E, F, G



Addington Type 20 Vertical / Horizontal



Addington Type 10 Towel Rail



Addington Type 20 Towel Rail

# Technical Tables & Drawings

## ADDINGTON TYPE 20 VERTICAL / HORIZONTAL

Perspective view

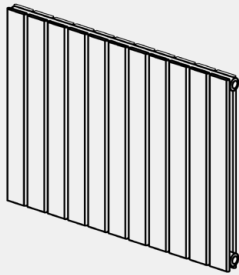

Front view

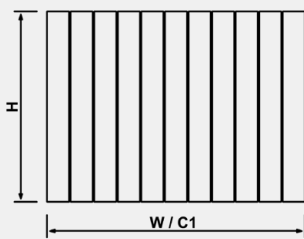

Side view

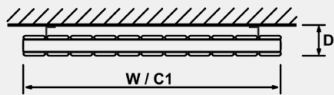
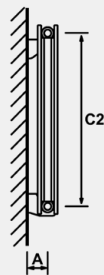

Bottom view

## ADDINGTON TYPE 10 TOWEL RAIL

Front view

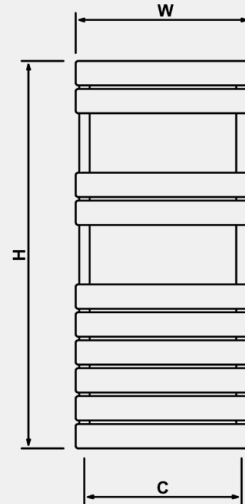

Side view



Perspective view

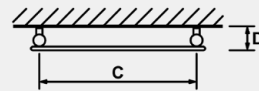
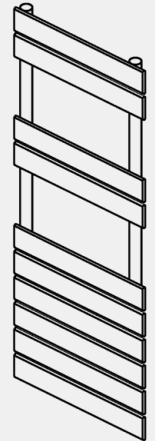

Bottom view

## ADDINGTON TYPE 20 TOWEL RAIL

Front view

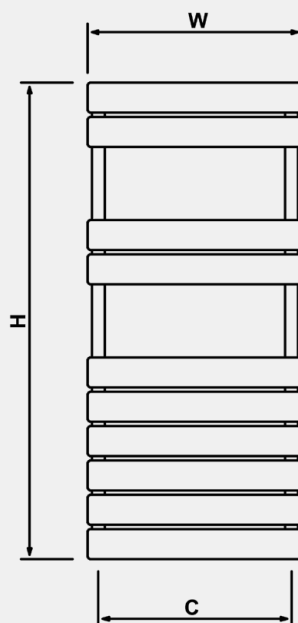

Side view



Perspective view

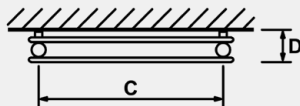
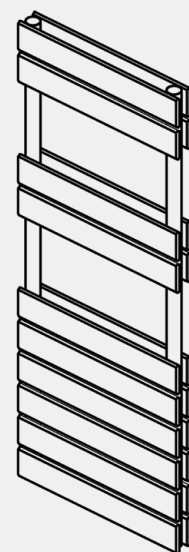

Bottom view

# Technical Tables & Drawings

## ADDINGTON - DESIGNER RANGE

**Addington Type 21 - Horizontal**

Height H (mm)	Width W (mm)	Tappings C (mm)	Distance from wall - D (mm)	Tappings from wall - A (mm)	Tube Qty	Water Content L	Weight KG	Colour	▲T60		Element Output	Element Type
									Watts	BTU		
558	600	550	115	75	16	6.75	20.48	Coloured	994	3392	600W	A+
558	800	750	115	75	16	8.52	26.86	Coloured	1325	4521	600W	A, A+
558	1000	950	115	75	16	10.28	33.23	Coloured	1694	5780	600W	A, A+
588	1200	1150	115	75	16	12.04	39.60	Coloured	1983	6766	600W	A, A+

**Addington Type 22 - Horizontal**

Height H (mm)	Width W (mm)	Tappings C (mm)	Distance from wall - D (mm)	Tappings from wall - A (mm)	Tube Qty	Water Content L	Weight KG	Colour	▲T60		Element Output	Element Type
									Watts	BTU		
292	1200	1150	135	85	8	5.80	21.70	Coloured	1703	5811	N/A	N/A
558	600	550	135	85	16	6.80	22.50	Coloured	1252	4272	600W	A+
558	800	750	135	85	16	8.40	29.50	Coloured	1670	5698	600W	A, A+
588	1000	950	135	85	16	10.00	36.40	Coloured	2099	7162	600W	A, A+
588	1200	1150	135	85	16	12.60	43.40	Coloured	2519	8595	600W	A, A+

**Addington Type 21 Towel Rail**

Height H (mm)	Width W (mm)	Tappings C (mm)	Distance from wall - D (mm)	Tappings from wall - A (mm)	Tube Qty	Water Content L	Weight KG	Colour	▲T60		Element Output	Element Type
									Watts	BTU		
1110	500	450	115	75	20	5.70	18.88	Coloured	1060	3615	600W	A, A+, D, E, F, G
1750	500	450	115	75	28	12.10	35.65	Coloured	1455	4962	900W	A, A+, D, E, F, G

## WINGRAVE FLAT PANEL - FLAT PANEL RANGE

**Wingrave Flat Panel**

Height H (mm)	Width W (mm)	Tappings C1/C2 (mm)	Distance from wall - D (mm)	Tappings from wall - A (mm)	Tube Qty	Water Content L	Weight KG	Colour	▲T60		Element Output	Element Type
									Watts	BTU		
1200	310	255/50	96	73	26	4.80	9.70	Coloured	470	1604	150W	A, A+, D, E, F, G
1200	410	355/50	96	73	26	5.60	11.50	Coloured	593	2023	300W	A, A+, D, E, F, G
1200	510	455/50	96	73	26	6.50	13.40	Coloured	716	2443	300W	A, A+, D, E, F, G
1200	610	555/50	96	73	26	7.30	15.40	Coloured	840	2866	450W	A, A+, D, E, F, G
1800	310	255/50	96	73	38	7.00	14.10	Coloured	694	2368	300W	A, A+, D, E, F, G
1800	410	355/50	96	73	38	8.30	16.90	Coloured	874	2982	450W	A, A+, D, E, F, G
1800	510	455/50	96	73	38	9.50	19.80	Coloured	1054	3596	450W	A, A+, D, E, F, G
1800	610	555/50	96	73	38	10.80	22.70	Coloured	1234	4211	600W	A, A+, D, E, F, G



Addington Type 21 Horizontal



Addington Type 22 Horizontal



Addington Type 21 Towel Rail



Wingrave Flat Panel

# Technical Tables & Drawings

## ADDINGTON TYPE 21 HORIZONTAL

## ADDINGTON TYPE 22 HORIZONTAL

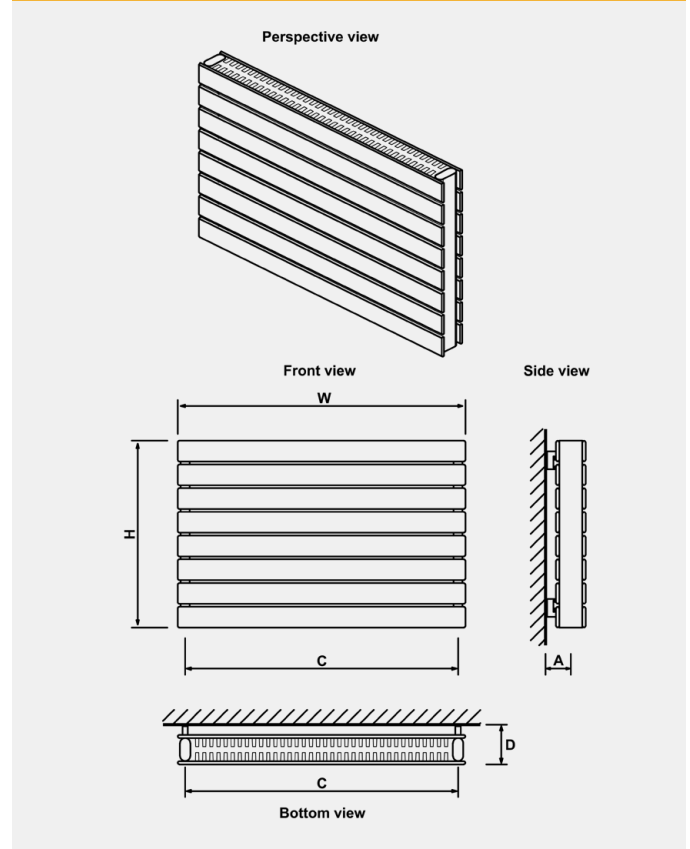
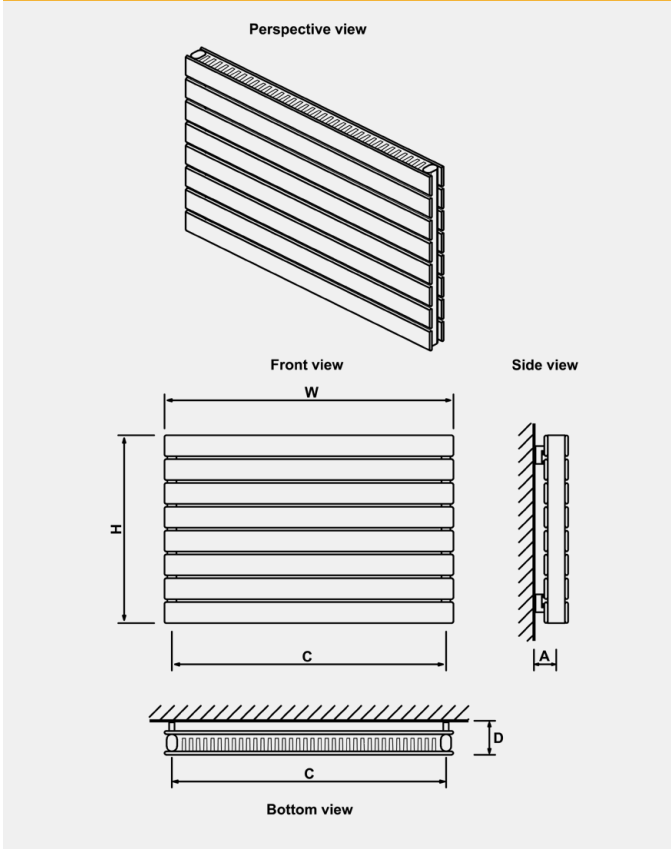

## ADDINGTON TYPE 21 TOWEL RAIL

## WINGRAVE FLAT PANEL

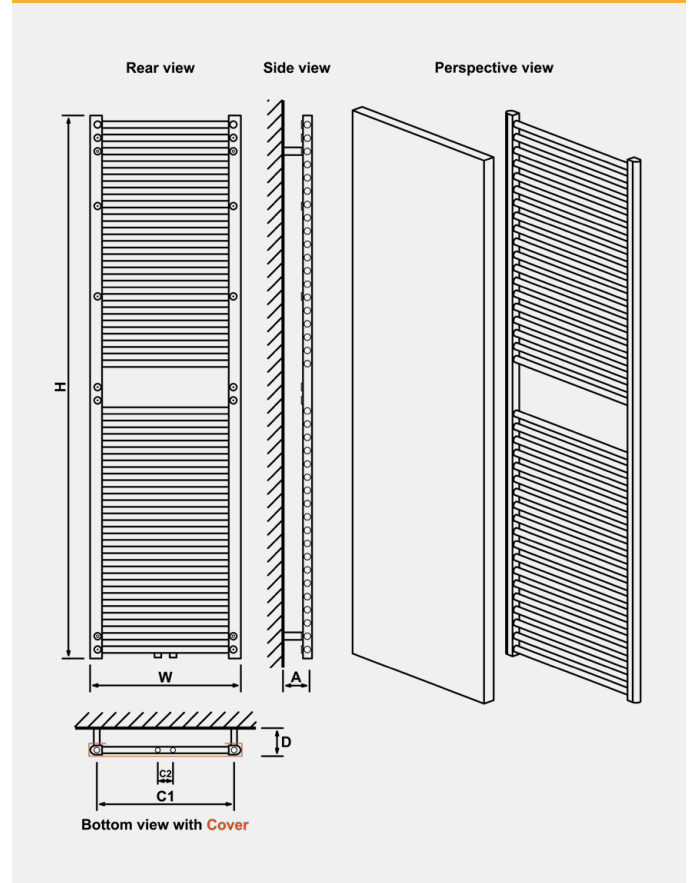
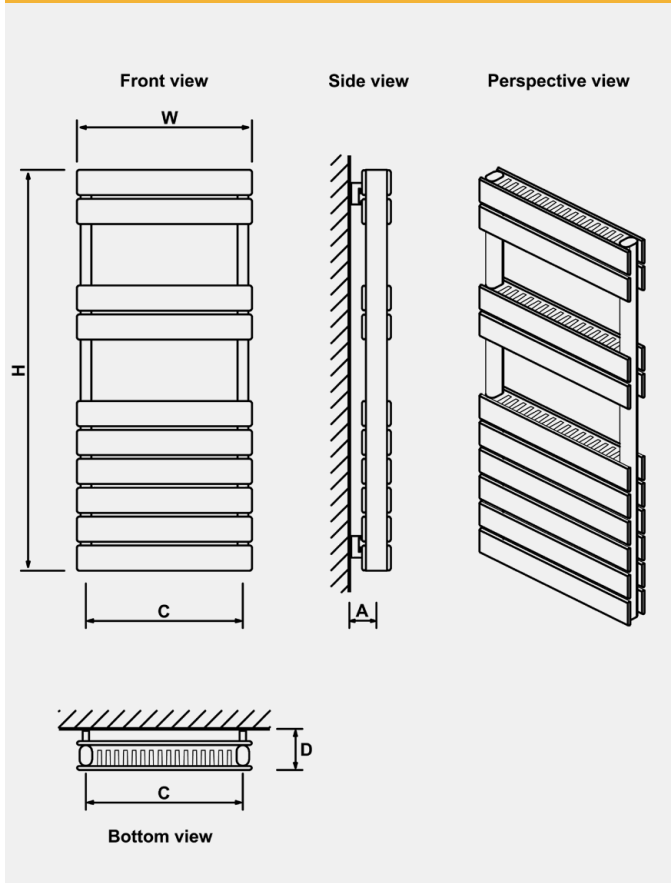

# Technical Tables & Drawings

## FLAT PANEL - FLAT PANEL RANGE

**Type 11 Flat Panel Radiator**

Height H (mm)	Width W (mm)	Tappings C1/C2 (mm)	Distance from wall - D (mm)	Tappings from wall - A (mm)	Tube Qty	Water Content L	Weight KG	Colour	▲T60		Element Output	Element Type	Colour	▲T60		Element Output	Element Type
									Watts	BTU				Watts	BTU		
400	600	600	76	42	-	-	8.7	Coloured	439	1497	-	-	-	-	-	-	-
400	800	800	76	42	-	-	11.5	Coloured	586	1998	-	-	-	-	-	-	-
400	1000	1000	76	42	-	-	14.4	Coloured	733	2500	-	-	-	-	-	-	-
400	1200	1200	76	42	-	-	17.3	Coloured	881	3005	-	-	-	-	-	-	-
400	1400	1400	76	42	-	-	20.1	Coloured	1027	3502	-	-	-	-	-	-	-
400	1600	1600	76	42	-	-	23.0	Coloured	1175	4007	-	-	-	-	-	-	-
500	400	400	76	42	-	-	7.1	Coloured	360	1225	-	-	-	-	-	-	-
500	600	600	76	42	-	-	10.8	Coloured	541	1844	-	-	-	-	-	-	-
500	800	800	76	42	-	-	14.2	Coloured	722	2460	-	-	-	-	-	-	-
500	1000	1000	76	42	-	-	17.7	Coloured	903	3080	-	-	-	-	-	-	-
500	1200	1200	76	42	-	-	21.2	Coloured	1085	3699	-	-	-	-	-	-	-
500	1400	1400	76	42	-	-	24.8	Coloured	1266	4315	-	-	-	-	-	-	-
500	1600	1600	76	42	-	-	28.3	Coloured	1447	4934	-	-	-	-	-	-	-
600	400	400	76	42	-	-	8.5	Coloured	424	1443	-	-	-	-	-	-	-
600	600	600	76	42	-	-	13.7	Coloured	638	2174	-	-	-	-	-	-	-
600	800	800	76	42	-	-	16.9	Coloured	851	2901	-	-	-	-	-	-	-
600	1000	1000	76	42	-	-	21.1	Coloured	1064	3628	-	-	-	-	-	-	-
600	1200	1200	76	42	-	-	25.3	Coloured	1277	4354	-	-	-	-	-	-	-
600	1400	1400	76	42	-	-	29.5	Coloured	1490	5081	-	-	-	-	-	-	-
600	1600	1600	76	42	-	-	33.7	Coloured	1705	5812	-	-	-	-	-	-	-
600	1800	1800	76	42	-	-	38.0	Coloured	1918	6538	-	-	-	-	-	-	-

## FLAT PANEL - FLAT PANEL RANGE

**Type 22 Flat Panel Radiator**

Height H (mm)	Width W (mm)	Tappings C (mm)	Distance from wall - D (mm)	Tappings from wall - A (mm)	Tube Qty	Water Content L	Weight KG	Colour	▲T60		Element Output	Element Type	Colour	▲T60		Element Output	Element Type
									Watts	BTU				Watts	BTU		
400	600	600	128.5 / 139.5	77 / 88	-	-	15.0	Coloured	815	2779	-	-	-	-	-	-	-
400	800	800	128.5 / 139.5	77 / 88	-	-	20.0	Coloured	1085	3699	-	-	-	-	-	-	-
400	1000	1000	128.5 / 139.5	77 / 88	-	-	24.9	Coloured	1354	4616	-	-	-	-	-	-	-
400	1200	1200	128.5 / 139.5	77 / 88	-	-	29.9	Coloured	1624	5536	-	-	-	-	-	-	-
400	1400	1400	128.5 / 139.5	77 / 88	-	-	34.9	Coloured	1894	6456	-	-	-	-	-	-	-
400	1600	1600	128.5 / 139.5	77 / 88	-	-	39.8	Coloured	2161	7369	-	-	-	-	-	-	-
500	400	400	128.5 / 139.5	77 / 88	-	-	11.4	Coloured	647	2206	-	-	-	-	-	-	-
500	600	600	128.5 / 139.5	77 / 88	-	-	17.1	Coloured	973	3316	-	-	-	-	-	-	-
500	800	800	128.5 / 139.5	77 / 88	-	-	22.8	Coloured	1297	4422	-	-	-	-	-	-	-
500	1000	1000	128.5 / 139.5	77 / 88	-	-	28.4	Coloured	1623	5532	-	-	-	-	-	-	-
500	1200	1200	128.5 / 139.5	77 / 88	-	-	34.1	Coloured	1947	6639	-	-	-	-	-	-	-
500	1400	1400	128.5 / 139.5	77 / 88	-	-	39.8	Coloured	2272	7745	-	-	-	-	-	-	-
500	1600	1600	128.5 / 139.5	77 / 88	-	-	45.5	Coloured	2597	8855	-	-	-	-	-	-	-
600	400	400	128.5 / 139.5	77 / 88	-	-	14.0	Coloured	765	2607	-	-	-	-	-	-	-
600	600	600	128.5 / 139.5	77 / 88	-	-	21.0	Coloured	1147	3910	-	-	-	-	-	-	-
600	800	800	128.5 / 139.5	77 / 88	-	-	27.9	Coloured	1529	5214	-	-	-	-	-	-	-
600	1000	1000	128.5 / 139.5	77 / 88	-	-	34.9	Coloured	1911	6517	-	-	-	-	-	-	-
600	1200	1200	128.5 / 139.5	77 / 88	-	-	41.9	Coloured	2294	7820	-	-	-	-	-	-	-
600	1400	1400	128.5 / 139.5	77 / 88	-	-	48.8	Coloured	2676	9124	-	-	-	-	-	-	-
600	1600	1600	128.5 / 139.5	77 / 88	-	-	55.8	Coloured	3058	10427	-	-	-	-	-	-	-
600	1800	1800	128.5 / 139.5	77 / 88	-	-	62.8	Coloured	3440	11730	-	-	-	-	-	-	-



Flat Panel Type 11 Radiator



Flat Panel Type 22 Radiator



# Technical Tables & Drawings

## TYPE 11 FLAT PANEL RADIATOR

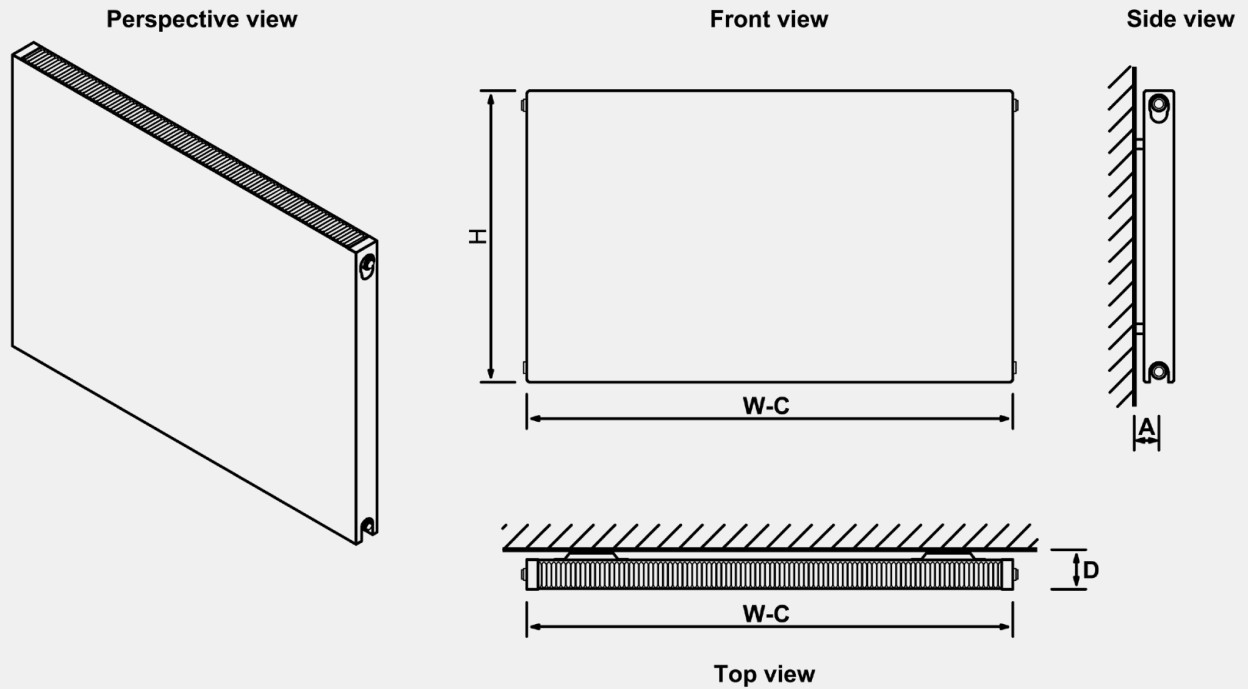

## TYPE 22 FLAT PANEL RADIATOR

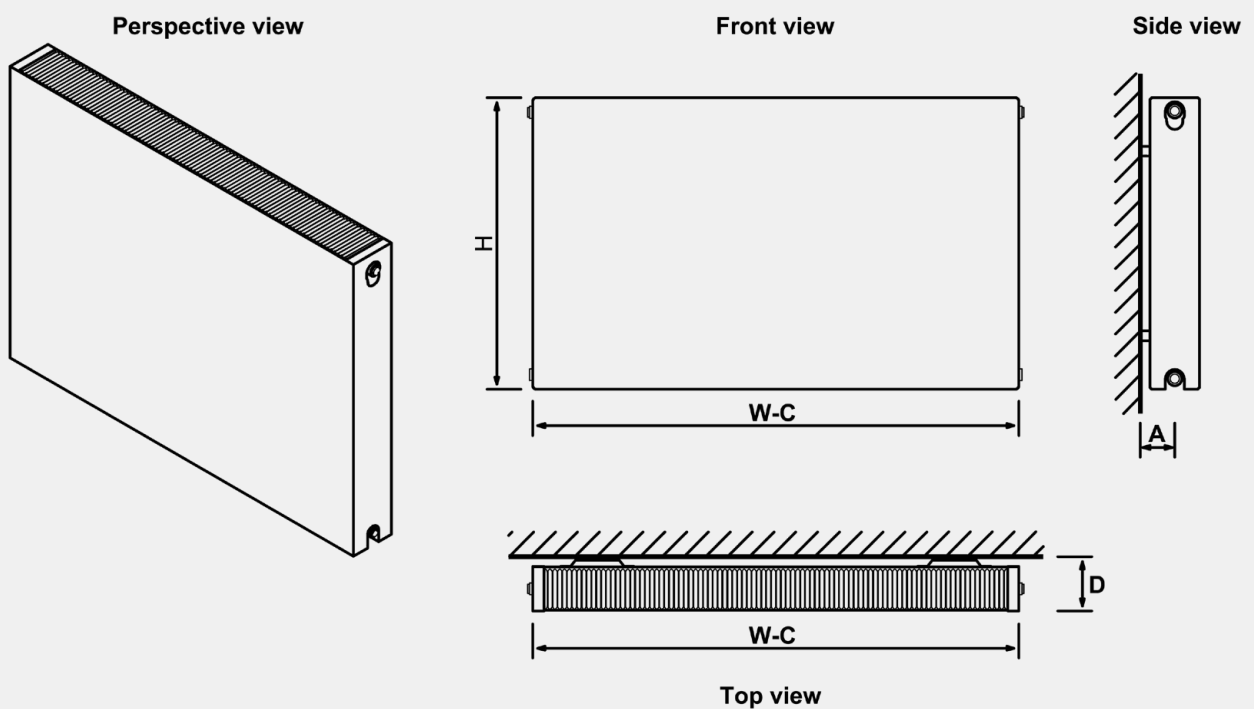

# Technical Tables & Drawings

## MERSEY VERTICAL - ALUMINIUM RANGE

Mersey Vertical																	
Height H (mm)	Width W (mm)	Tappings C1/C2 (mm)	Distance from wall - D (mm)	Tappings from wall - A (mm)	Tube Qty	Water Content L	Weight KG	Colour	▲T60		Element Output	Element Type	Colour	▲T60		Element Output	Element Type
									Watts	BTU				Watts	BTU		
1800	280	280	76	38	3	-	6.64	Coloured	776	2647	N/A	N/A	-	-	-	-	-
1800	375	375	76	38	4	-	8.75	Coloured	1034	3528	N/A	N/A	-	-	-	-	-
1800	470	470	76	38	5	-	10.86	Coloured	1293	4412	N/A	N/A	-	-	-	-	-
1800	565	565	76	38	6	-	12.98	Coloured	1552	5295	N/A	N/A	-	-	-	-	-
1800	660	660	76	38	7	-	15.09	Coloured	1810	6176	N/A	N/A	-	-	-	-	-

## TRENT VERTICAL - ALUMINIUM RANGE

Trent Vertical																	
Height H (mm)	Width W (mm)	Tappings C (mm)	Distance from wall - D (mm)	Tappings from wall - A (mm)	Tube Qty	Water Content L	Weight KG	Colour	▲T60		Element Output	Element Type	Colour	▲T60		Element Output	Element Type
									Watts	BTU				Watts	BTU		
1800	280	280	76	38	3	-	6.58	Coloured	762	2600	N/A	N/A	-	-	-	-	-
1800	375	375	76	38	4	-	8.68	Coloured	1017	3470	N/A	N/A	-	-	-	-	-
1800	470	470	76	38	5	-	10.77	Coloured	1271	4337	N/A	N/A	-	-	-	-	-
1800	565	565	76	38	6	-	12.87	Coloured	1525	5203	N/A	N/A	-	-	-	-	-
1800	660	660	76	38	7	-	14.97	Coloured	1779	6070	N/A	N/A	-	-	-	-	-



Mersey Vertical



Trent Vertical

# Technical Tables & Drawings

## MERSEY VERTICAL

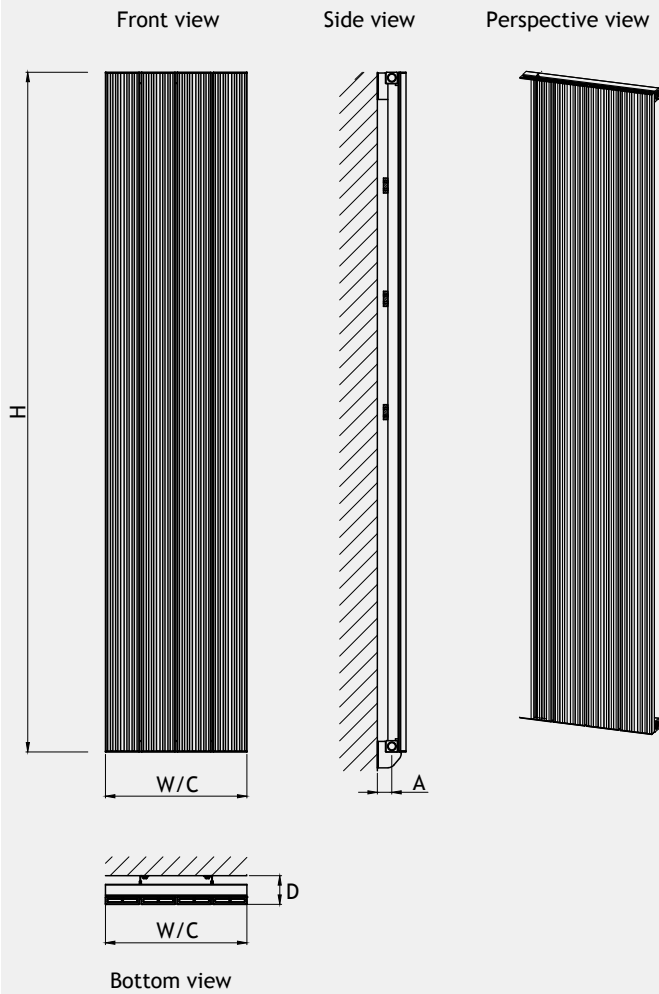

## TRENT VERTICAL

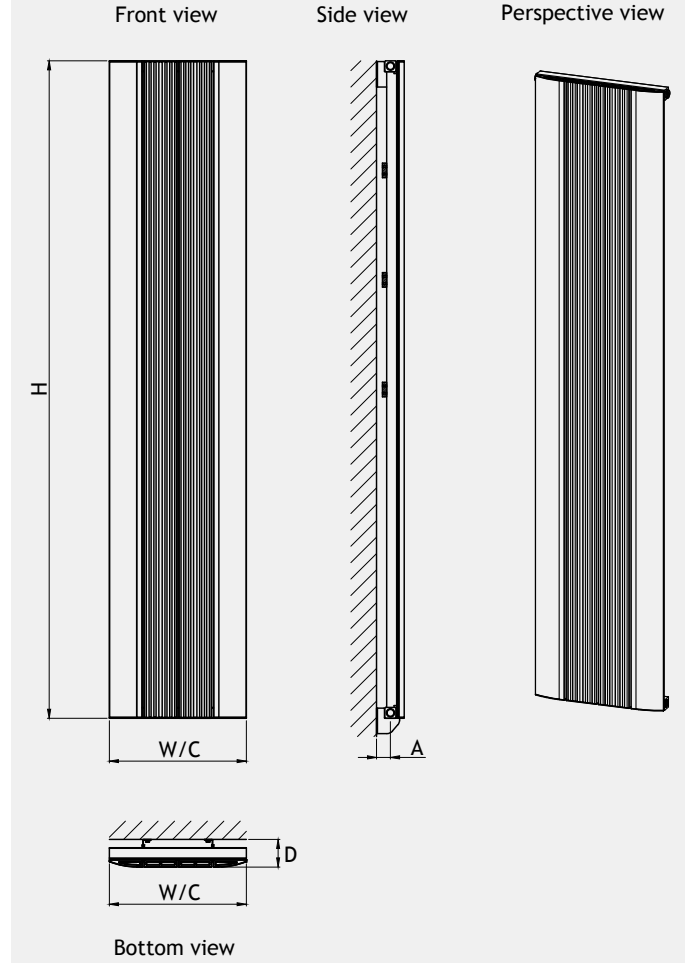

# Technical Tables & Drawings

## PELAGO - ALUMINIUM RANGE

### Pelago Towel Rail

Height H (mm)	Width W (mm)	Tappings C (mm)	Distance from wall - D (mm)	Tappings from wall - A (mm)	Tube Qty	Water Content L	Weight KG	Colour	▲T60		Element Output	Element Type	Colour	▲T60		Element Output	Element Type
									Watts	BTU				Watts	BTU		
600	500	475	88-118	75-105	5	0.73	2.3	Coloured	296	1011	150W	A, A+, D, E	Polished	287	981	150W	A, A+
600	600	575	88-118	75-105	5	0.80	2.6	Coloured	356	1213	150W	A, A+, D, E	Polished	345	1177	150W	A, A+
1200	500	475	88-118	75-105	9	1.37	4.3	Coloured	566	1931	300W	A, A+, D, E	Polished	549	1873	300W	A, A+
1200	600	575	88-118	75-105	9	1.51	4.8	Coloured	679	2317	300W	A, A+, D, E	Polished	659	2248	300W	A, A+
1800	500	475	88-118	75-105	14	2.10	6.5	Coloured	907	3094	450W	A+, D, E	Polished	880	3001	450W	A, A+
1800	600	575	88-118	75-105	14	2.31	7.3	Coloured	1088	3712	600W	A, A+, D, E	Polished	1055	3601	600W	A, A+

## VELOR - ALUMINIUM RANGE

### Velor Towel Rail

Height H (mm)	Width W (mm)	Tappings C (mm)	Distance from wall - D (mm)	Tappings from wall - A (mm)	Tube Qty	Water Content L	Weight KG	Colour	▲T60		Element Output	Element Type
									Watts	BTU		
600	500	475	100-130	80-110	8	0.70	3.4	Coloured	266	908	150W	A, A+, D, E
600	600	575	100-130	80-110	8	0.80	3.8	Coloured	319	1090	150W	A, A+, D, E
1200	500	475	100-130	80-110	21	1.81	7.8	Coloured	699	2384	300W	A, A+, D, E
1200	600	575	100-130	80-110	21	2.10	8.9	Coloured	838	2861	450W	A, A+, D, E
1800	500	475	100-130	80-110	31	2.67	11.4	Coloured	1031	3519	600W	A, A+, D, E
1800	600	575	100-130	80-110	31	3.10	13.1	Coloured	1238	4223	750W	A, A+, D, E

## CHARLTON - ALUMINIUM RANGE

### Charlton - Vertical

Height H (mm)	Width W (mm)	Tappings C (mm)	Distance from wall - D (mm)	Tappings from wall - A (mm)	Tube Qty	Water Content L	Weight KG	Colour	▲T60		Element Output	Element Type
									Watts	BTU		
600	280	280	71/91	33/53	3	0.60	3.75	Coloured	305	1041	150W	A, A+, F, G
1200	280	280	71/91	33/53	3	1.20	4.60	Coloured	585	1997	300W	A, A+, F, G
1200	375	375	71/91	33/53	4	1.60	6.10	Coloured	775	2645	300W	A, A+, F, G
1200	470	470	71/91	33/53	5	2.00	7.70	Coloured	963	3286	450W	A, A+, F, G
1200	565	565	71/91	33/53	6	2.40	9.20	Coloured	1150	3924	600W	A, A+, F, G
1800	280	280	71/91	33/53	3	1.80	8.1	Coloured	844	2880	450W	A, A+, F, G
1800	375	375	71/91	33/53	4	2.40	10.3	Coloured	1119	3819	600W	A, A+, F, G
1800	470	470	71/91	33/53	5	3.00	12.8	Coloured	1391	4747	750W	A, A+, F, G
1800	565	565	71/91	33/53	6	3.50	14.80	Coloured	1661	5668	1000W	A, A+, F, G

### Charlton - Horizontal

Height H (mm)	Width W (mm)	Tappings C (mm)	Distance from wall - D (mm)	Tappings from wall - A (mm)	Tube Qty	Water Content L	Weight KG	Colour	▲T60		Element Output	Element Type
									Watts	BTU		
600	470	470	71/91	33/53	5	1.10	5.70	Coloured	503	1717	300W	A, A+, C, H
600	660	660	71/91	33/53	7	1.50	7.80	Coloured	697	2379	450W	A, A+, C, H
600	850	850	71/91	33/53	9	2.00	9.50	Coloured	890	3037	600W	A, A+, C, H
600	1040	1040	71/91	33/53	11	2.40	11.50	Coloured	1081	3689	750W	A, A+, C, H
600	1230	1230	71/91	33/53	13	2.90	13.50	Coloured	1271	4337	900W	A, A+, C, H
600	1420	1420	71/91	33/53	15	3.30	12.30	Coloured	1460	4982	900W	A, A+, C, H



Pelago Towel Rail



Velor Towel Rail

Charlton  
VerticalCharlton  
Horizontal

# Technical Tables & Drawings

## PELAGO TOWEL RAIL

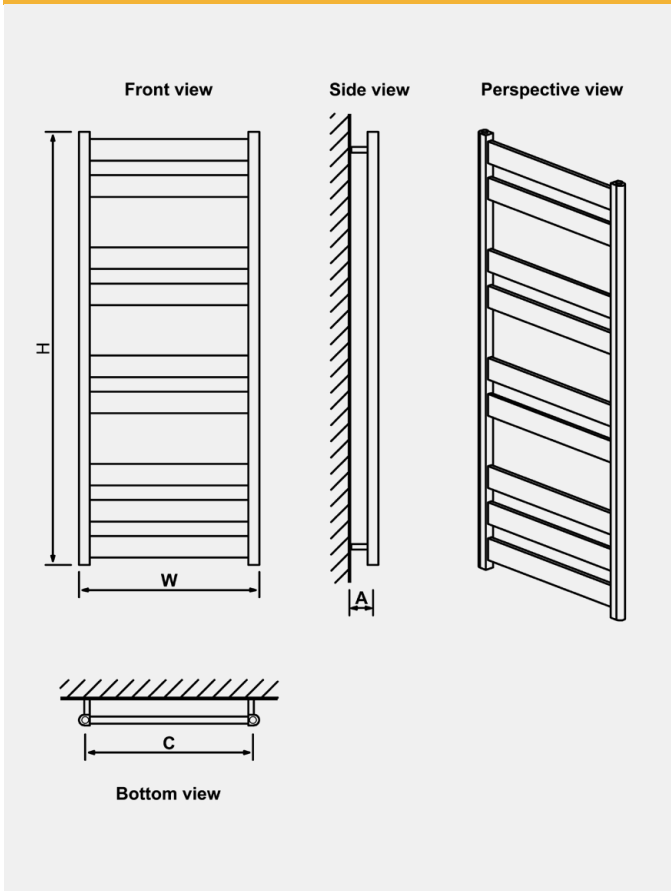

## VELOR TOWEL RAIL

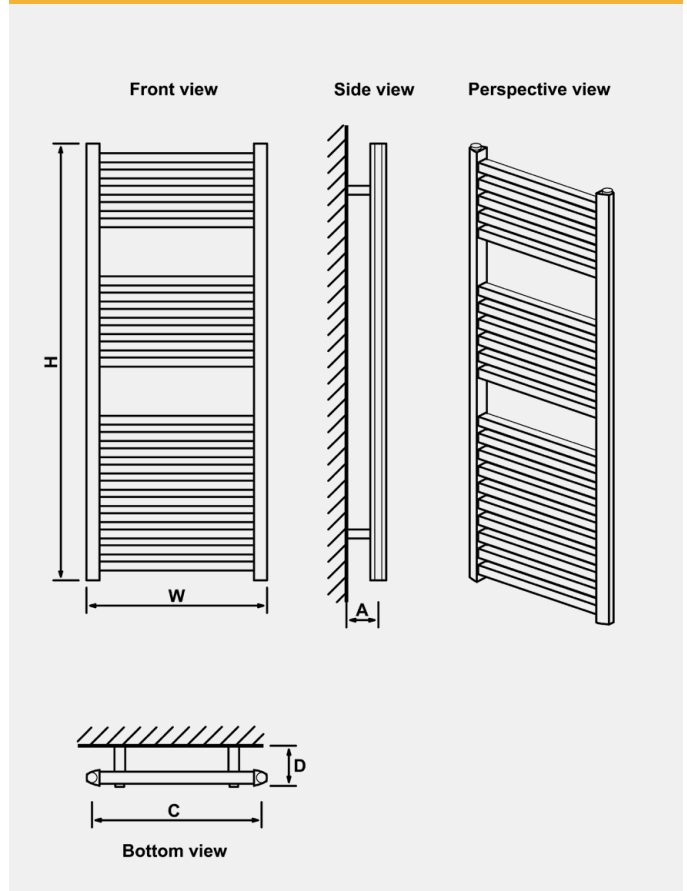

## CHARLTON - VERTICAL

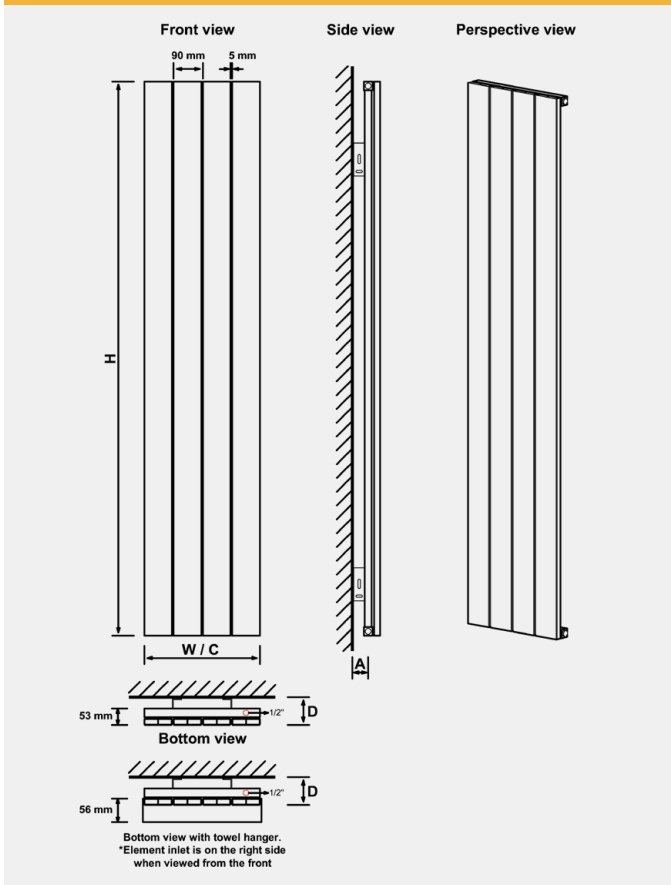

## CHARLTON - HORIZONTAL

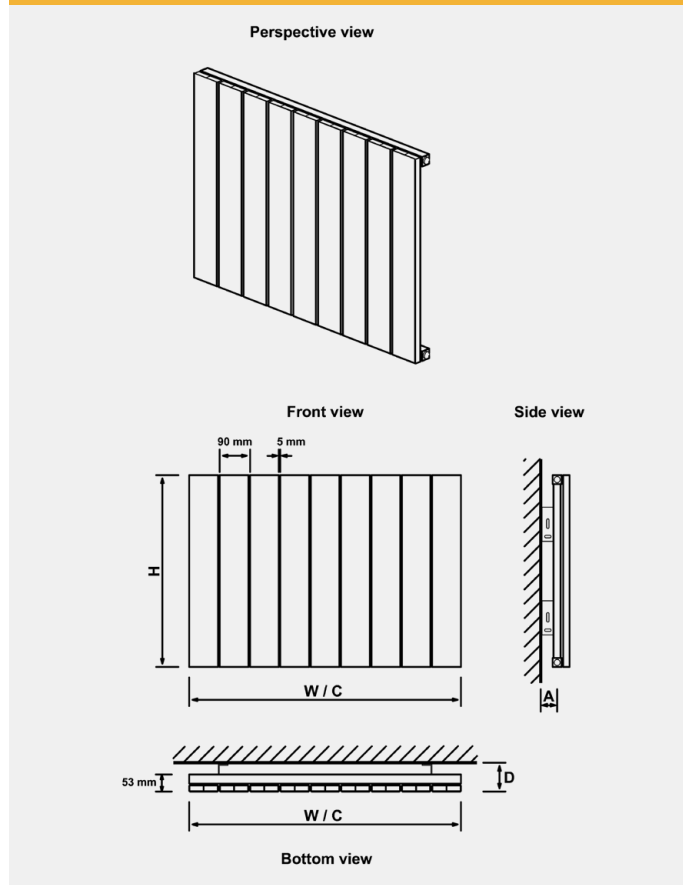

# Technical Tables & Drawings

## WITHINGTON - ALUMINIUM RANGE

### Withington - Vertical

Height H (mm)	Width W (mm)	Tappings C (mm)	Distance from wall - D (mm)	Tappings from wall - A (mm)	Tube Qty	Water Content L	Weight KG	Colour	▲T60		Element Output	Element Type
									Watts	BTU		
600	280	280	71/91	33/53	3	0.60	3.75	Coloured	305	1041	150W	A, A+, F, G
1200	280	280	71/91	33/53	3	1.20	4.30	Coloured	559	1908	300W	A, A+, F, G
1200	375	375	71/91	33/53	4	1.60	5.80	Coloured	742	2532	300W	A, A+, F, G
1200	470	470	71/91	33/53	5	2.00	7.30	Coloured	922	3146	450W	A, A+, F, G
1200	565	565	71/91	33/53	6	2.40	8.80	Coloured	1101	3757	600W	A, A+, F, G
1800	280	280	71/91	33/53	3	1.80	8.00	Coloured	812	2771	450W	A, A+, F, G
1800	375	375	71/91	33/53	4	2.40	10.20	Coloured	1076	3672	600W	A, A+, F, G
1800	470	470	71/91	33/53	5	3.00	12.70	Coloured	1338	4566	750W	A, A+, F, G
1800	565	565	71/91	33/53	6	3.50	14.80	Coloured	1598	5453	1000W	A, A+, F, G

### Withington - Horizontal

Height H (mm)	Width W (mm)	Tappings C (mm)	Distance from wall - D (mm)	Tappings from wall - A (mm)	Tube Qty	Water Content L	Weight KG	Colour	▲T60		Element Output	Element Type
									Watts	BTU		
600	470	470	71/91	33/53	5	1.10	5.70	Coloured	502	1713	300W	A, A+, C, H
600	660	660	71/91	33/53	7	1.50	7.80	Coloured	697	2379	450W	A, A+, C, H
600	850	850	71/91	33/53	9	2.00	9.50	Coloured	889	3034	600W	A, A+, C, H
600	1040	1040	71/91	33/53	11	2.40	11.50	Coloured	1080	3685	750W	A, A+, C, H
600	1230	1230	71/91	33/53	13	2.90	13.50	Coloured	1270	4334	900W	A, A+, C, H
600	1420	1420	71/91	33/53	15	3.30	13.00	Coloured	1459	4979	900W	A, A+, C, H

## MALMESBURY - ALUMINIUM RANGE

### Malmesbury - Vertical

Height H (mm)	Width W (mm)	Tappings C (mm)	Distance from wall - D (mm)	Tappings from wall - A (mm)	Tube Qty	Water Content L	Weight KG	Colour	▲T60		Element Output	Element Type
									Watts	BTU		
1200	185	185	71/91	33/53	2	0.80	2.90	Coloured	375	1280	150W	A, A+, F, G
1200	280	280	71/91	33/53	3	1.20	4.40	Coloured	554	1891	300W	A, A+, F, G
1200	375	375	71/91	33/53	4	1.60	5.70	Coloured	730	2491	300W	A, A+, F, G
1200	470	470	71/91	33/53	5	2.00	7.30	Coloured	903	3082	450W	A, A+, F, G
1200	565	565	71/91	33/53	6	2.40	8.30	Coloured	1074	3665	600W	A, A+, F, G
1800	185	185	71/91	33/53	2	1.18	5.6	Coloured	544	1857	300W	A, A+, F, G
1800	280	280	71/91	33/53	3	1.80	7.9	Coloured	804	2744	450W	A, A+, F, G
1800	375	375	71/91	33/53	4	2.40	10.1	Coloured	1060	3617	600W	A, A+, F, G
1800	470	470	71/91	33/53	5	3.00	12.6	Coloured	1311	4474	750W	A, A+, F, G
1800	565	565	71/91	33/53	6	3.50	13.80	Coloured	1560	5323	1000W	A, A+, F, G

### Malmesbury - Horizontal

Height H (mm)	Width W (mm)	Tappings C (mm)	Distance from wall - D (mm)	Tappings from wall - A (mm)	Tube Qty	Water Content L	Weight KG	Colour	▲T60		Element Output	Element Type
									Watts	BTU		
500	375	375	79/99	33/53	4	0.94	4.3	Coloured	340	1161	150W	A, A+, C, H
500	470	470	79/99	33/53	5	1.18	5.1	Coloured	421	1437	150W	A, A+, C, H
500	565	565	79/99	33/53	6	1.41	6.0	Coloured	500	1706	300W	A, A+, C, H
600	375	375	79/99	33/53	4	1.75	4.6	Coloured	397	1355	150W	A, A+, C, H
600	470	470	79/99	33/53	5	2.17	5.7	Coloured	491	1676	300W	A, A+, C, H
600	565	565	79/99	33/53	6	2.50	6.6	Coloured	585	1997	300W	A, A+, C, H
600	850	850	79/99	33/53	9	3.75	9.5	Coloured	859	2931	450W	A, A+, C, H
600	1040	1040	79/99	33/53	11	4.58	11.3	Coloured	1039	3546	600W	A, A+, C, H
600	1230	1230	79/99	33/53	13	5.42	13.0	Coloured	1217	4153	750W	A, A+, C, H
600	1420	1420	79/99	33/53	15	3.30	12.6	Coloured	1394	4757	900W	A, A+, C, H



Withington  
Vertical



Withington  
Horizontal



Malmesbury  
Vertical



Malmesbury  
Horizontal

# Technical Tables & Drawings

## WITHINGTON - VERTICAL

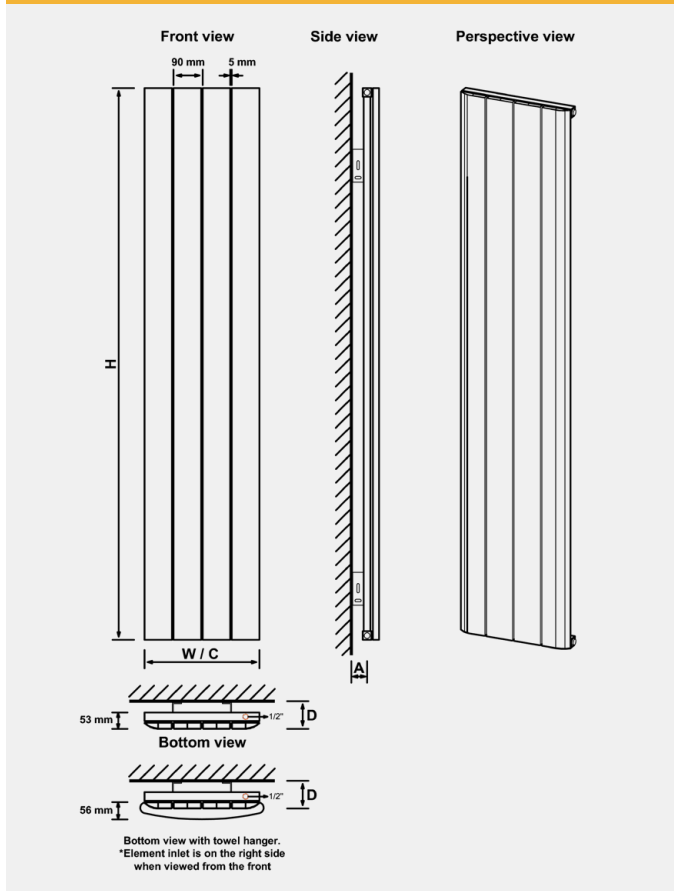

## WITHINGTON - HORIZONTAL

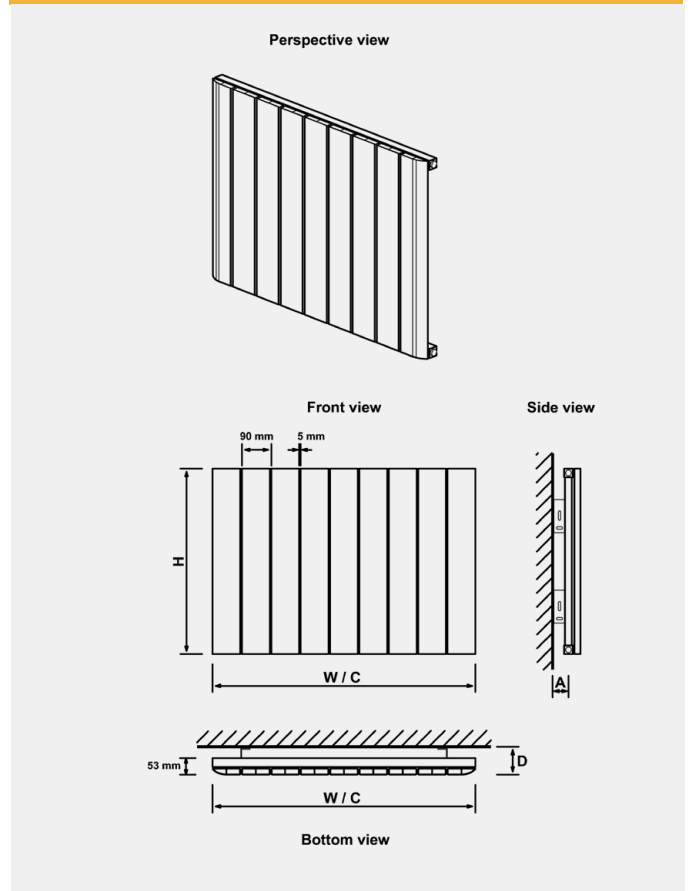

## MALMESBURY - VERTICAL

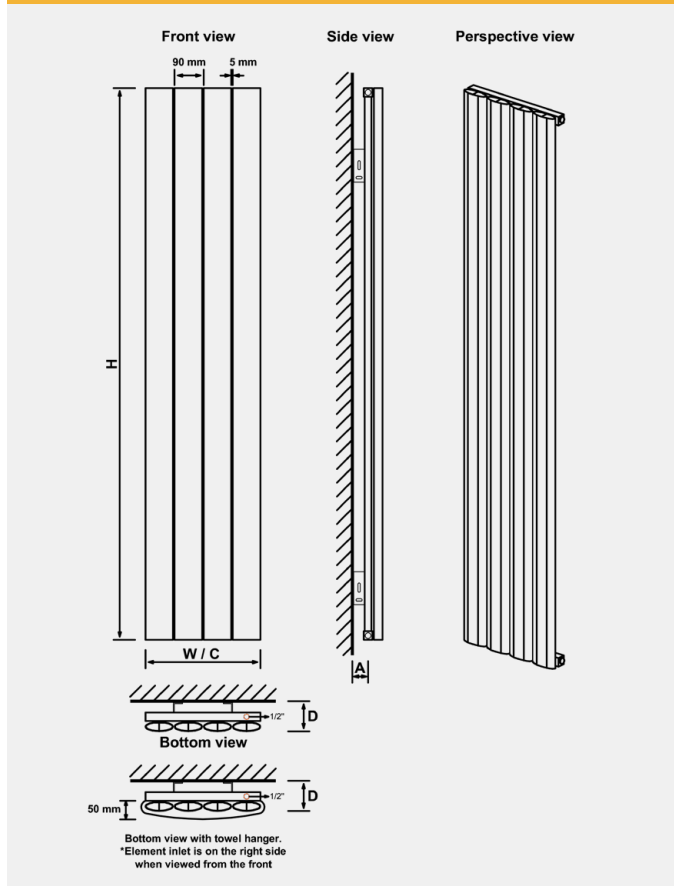

## MALMESBURY - HORIZONTAL

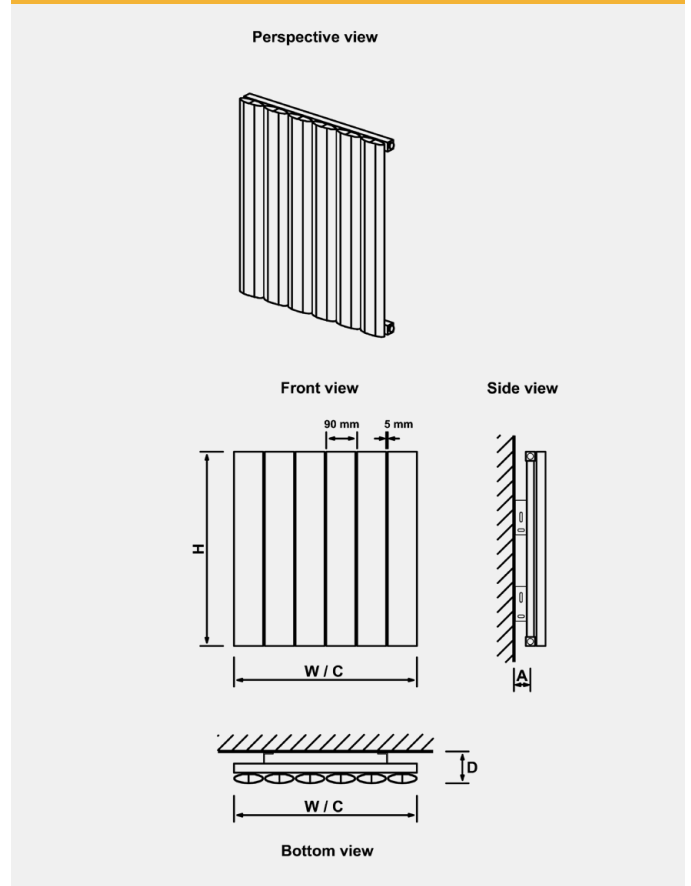

# Technical Tables & Drawings

## ADDINGTON ALUMINIUM - ALUMINIUM RANGE

### Addington Aluminium Type10 - Vertical / Horizontal

Height H (mm)	Width W (mm)	Tappings C (mm)	Distance from wall - D (mm)	Tappings from wall - A (mm)	Tube Qty	Water Content L	Weight KG	Colour	▲T60		Element Output	Element Type
									Watts	BTU		
500	514	514	76.5	45	7	1.14	5.83	Coloured	443	1512	150W	A
500	588	588	76.5	45	8	1.30	6.66	Coloured	507	1728	150W	A
600	292	292	76.5	45	4	0.76	3.81	Coloured	315	1074	150W	A
600	366	366	76.5	45	5	0.96	4.60	Coloured	393	1342	150W	A
600	440	440	76.5	45	6	1.15	5.66	Coloured	472	11610	150W	A
600	514	514	76.5	45	7	1.34	6.42	Coloured	551	1879	300W	A
600	588	588	76.5	45	8	1.53	7.39	Coloured	629	2147	300W	A
600	662	662	76.5	45	9	1.72	8.26	Coloured	708	2416	300W	A
600	810	810	76.5	45	11	2.10	10.10	Coloured	865	2952	300W	A
600	1032	1032	76.5	45	14	2.67	12.86	Coloured	1101	3758	600W	A
600	1180	1180	76.5	45	16	3.06	15.10	Coloured	1259	4294	600W	A
600	1254	1254	76.5	45	17	3.25	15.96	Coloured	1337	4563	600W	A
800	514	514	76.5	45	7	1.74	8.02	Coloured	709	2420	300W	A
800	588	588	76.5	45	8	1.98	9.16	Coloured	811	2766	300W	A
1000	514	514	76.5	45	7	2.13	9.43	Coloured	862	2940	300W	A
1000	588	588	76.5	45	8	2.43	10.74	Coloured	985	3360	300W	A
1200	514	514	76.5	45	7	2.53	10.72	Coloured	1010	3446	300W	A
1200	588	588	76.5	45	8	2.89	12.23	Coloured	1154	3938	600W	A
1400	514	514	76.5	45	7	2.93	12.13	Coloured	1154	3937	600W	A
1400	588	588	76.5	45	8	3.34	13.88	Coloured	1319	4499	600W	A
1800	292	292	76.5	45	4	2.12	8.65	Coloured	816	2786	600W	A
1800	366	366	76.5	45	5	2.66	10.19	Coloured	1021	3482	600W	A
1800	440	440	76.5	45	6	3.19	12.85	Coloured	1225	4179	600W	A
1800	514	514	76.5	45	7	3.72	15.05	Coloured	1429	4875	900W	A
1800	588	588	76.5	45	8	4.25	17.09	Coloured	1633	5572	900W	A

### Addington Aluminium Type20 - Vertical / Horizontal

Height H (mm)	Width W (mm)	Tappings C (mm)	Distance from wall - D (mm)	Tappings from wall - A (mm)	Tube Qty	Water Content L	Weight KG	Colour	▲T60		Element Output	Element Type
									Watts	BTU		
600	292	292	96.5	65	8	0.76	5.09	Coloured	442	1509	150W	A
600	366	366	96.5	65	10	0.96	6.34	Coloured	553	1887	300W	A
600	440	440	96.5	65	12	1.15	7.53	Coloured	664	2264	300W	A
600	514	514	96.5	65	14	1.34	8.54	Coloured	774	2641	300W	A
600	588	588	96.5	65	16	1.53	9.79	Coloured	885	3019	300W	A
600	662	662	96.5	65	18	1.72	11.34	Coloured	995	3396	300W	A
600	810	810	96.5	65	22	2.10	13.42	Coloured	1216	4151	600W	A
600	1032	1032	96.5	65	28	2.67	17.53	Coloured	1548	5283	600W	A
600	1180	1180	96.5	65	32	3.06	19.49	Coloured	1769	6038	900W	A
600	1254	1254	96.5	65	34	3.25	20.68	Coloured	1880	6415	900W	A
1800	366	366	96.5	65	10	2.66	15.89	Coloured	1435	4896	600W	A
1800	440	440	96.5	65	12	3.19	18.82	Coloured	1722	5875	900W	A
1800	514	514	96.5	65	14	3.72	21.94	Coloured	2009	6854	900W	A
1800	588	588	96.5	65	16	4.25	25.18	Coloured	2296	7834	900W	A



Addington Aluminium Type 10  
Horizontal



Addington Aluminium Type 10  
Vertical



Addington Aluminium Type 20  
Horizontal



Addington Aluminium Type 20  
Vertical



# Technical Tables & Drawings

## ADDINGTON ALUMINIUM TYPE 10 HORIZONTAL

Perspective view

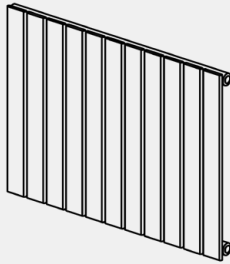

Front view

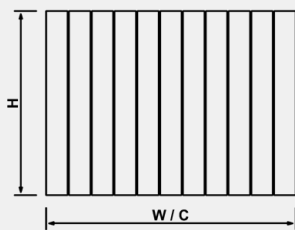

Side view

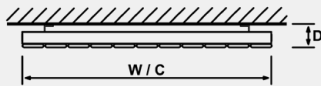

Bottom view

## ADDINGTON ALUMINIUM TYPE 10 VERTICAL

Front view

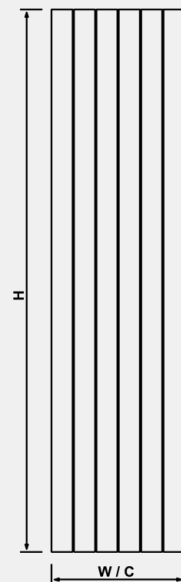

Side view



Perspective view

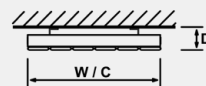
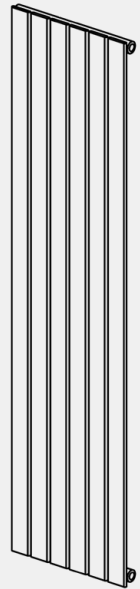

Bottom view

## ADDINGTON ALUMINIUM TYPE 20 HORIZONTAL

Perspective view

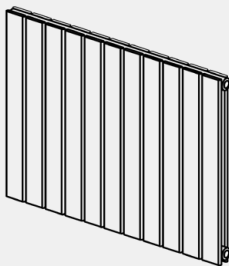

Front view

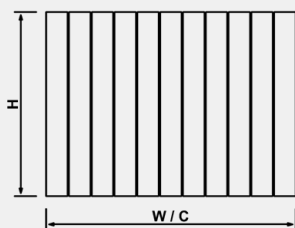

Side view

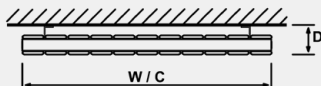

Bottom view

## ADDINGTON ALUMINIUM TYPE 20 VERTICAL

Front view

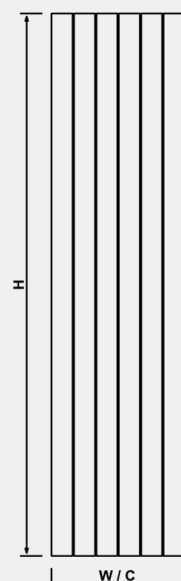

Side view



Perspective view

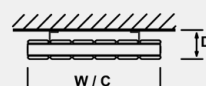
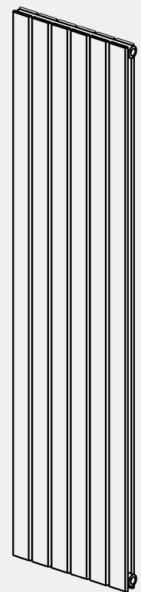

Bottom view

# Technical Tables & Drawings

## ROSANO - ALUMINIUM RANGE

### Rosano - Vertical

Height H (mm)	Width W (mm)	Tappings C1 / C2* (mm)	Distance from wall - D (mm)	Tappings from wall - A (mm)	Tube Qty	Water Content L	Weight KG	Colour	▲T60		Element Output	Element Type
									Watts	BTU		
600	280	280/190	70/90	35/55	3	0.58	4.6	Coloured	316	1078	150W	A, A+
1800	280	280/190	70/90	35/55	3	1.75	10.0	Coloured	948	3235	450W	A, A+
1800	375	375/285	70/90	35/55	4	2.33	13.1	Coloured	1264	4313	750W	A, A+
1800	470	470/380	70/90	35/55	5	2.91	16.2	Coloured	1580	5391	900W	A, A+
1800	565	565/475	70/90	35/55	6	3.52	19.50	Coloured	1896	6469	1000W	A, A+

\* Tappings C1 : Side connection, Tappings C2 : Bottom connection.

### Rosano - Horizontal

Height H (mm)	Width W (mm)	Tappings C (mm)	Distance from wall - D (mm)	Tappings from wall - A (mm)	Tube Qty	Water Content L	Weight KG	Colour	▲T60		Element Output	Element Type
									Watts	BTU		
600	470	470	70/90	35/55	5	0.96	6.7	Coloured	555	1894	300W	A, A+, C, H
600	660	660	70/90	35/55	7	1.34	9.1	Coloured	777	2651	450W	A, A+, C, H
600	850	850	70/90	35/55	9	1.73	11.5	Coloured	999	3409	600W	A, A+, C, H
600	1040	1040	70/90	35/55	11	2.11	13.9	Coloured	1221	4166	750W	A, A+, C, H
600	1230	1230	70/90	35/55	13	2.50	16.3	Coloured	1443	4924	900W	A, A+, C, H

## PERETTI - ALUMINIUM RANGE

### Peretti - Vertical

Height H (mm)	Width W (mm)	Tappings C1 / C2** (mm)	Distance from wall - D (mm)	Tappings from wall - A (mm)	Tube Qty	Water Content L	Weight KG	Colour	▲T60		Element Output	Element Type
									Watts	BTU		
600	280	280/190	70/90	35/55	3	0.58	4.6	Coloured	316	1078	150W	A, A+
1800	280	280/190	70/90	35/55	3	1.75	10.0	Coloured	948	3235	450W	A, A+
1800	375	375/285	70/90	35/55	4	2.33	13.1	Coloured	1264	4313	750W	A, A+
1800	470	470/380	70/90	35/55	5	2.91	16.2	Coloured	1580	5391	900W	A, A+
1800	565	565/475	70/90	35/55	6	3.52	19.50	Coloured	1896	6469	1000W	A, A+

\* Polished Aluminium heat outputs approx 3% lower than the coloured models.

\*\* Tappings C1 : Side connection, Tappings C2 : Bottom connection.

### Peretti - Horizontal

Height H (mm)	Width W (mm)	Tappings C (mm)	Distance from wall - D (mm)	Tappings from wall - A (mm)	Tube Qty	Water Content L	Weight KG	Colour	▲T60		Element Output	Element Type
									Watts	BTU		
600	470	470	70/90	35/55	5	0.96	6.7	Coloured	555	1894	300W	A, A+, C, H
600	660	660	70/90	35/55	7	1.34	9.1	Coloured	777	2651	450W	A, A+, C, H
600	850	850	70/90	35/55	9	1.73	11.5	Coloured	999	3409	600W	A, A+, C, H
600	1040	1040	70/90	35/55	11	2.11	13.9	Coloured	1221	4166	750W	A, A+, C, H
600	1230	1230	70/90	35/55	13	2.50	16.3	Coloured	1443	4924	900W	A, A+, C, H

\* Polished Aluminium heat outputs approx 3% lower than the coloured models.



Rosano  
Vertical



Rosano  
Horizontal



Peretti  
Vertical



Peretti  
Horizontal

# Technical Tables & Drawings

## ROSANO - VERTICAL

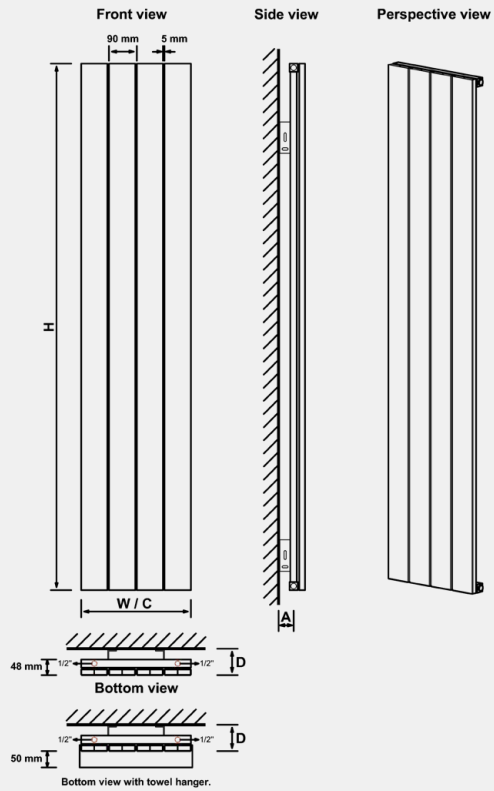

## ROSANO - HORIZONTAL

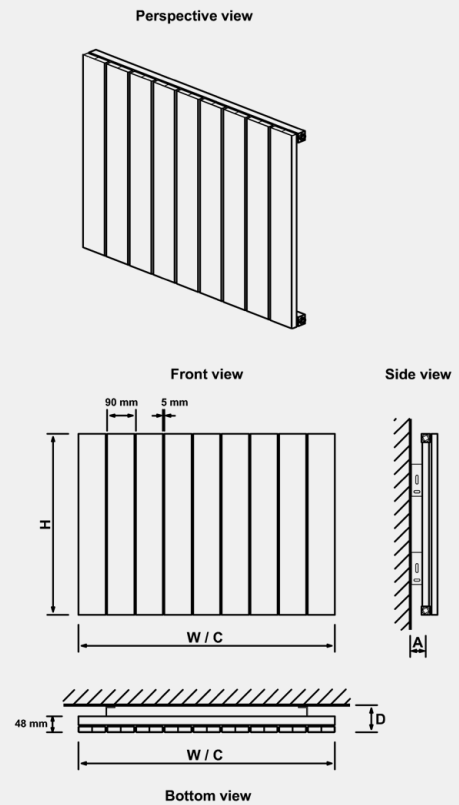

## PERETTI - VERTICAL

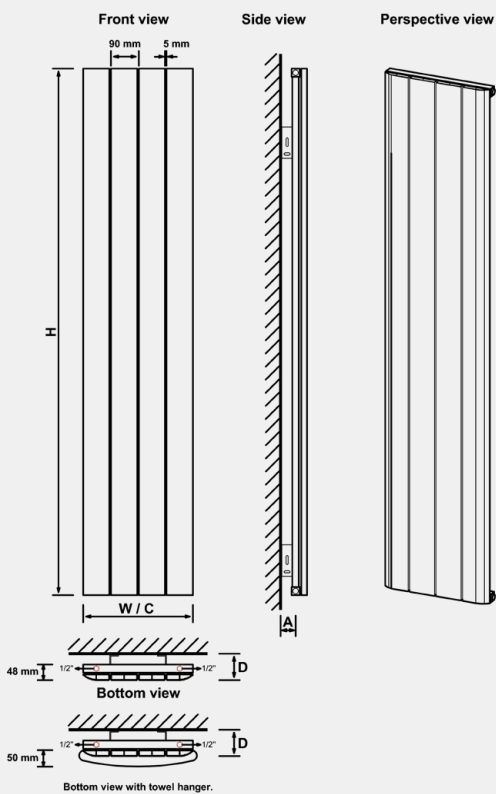

## PERETTI - HORIZONTAL

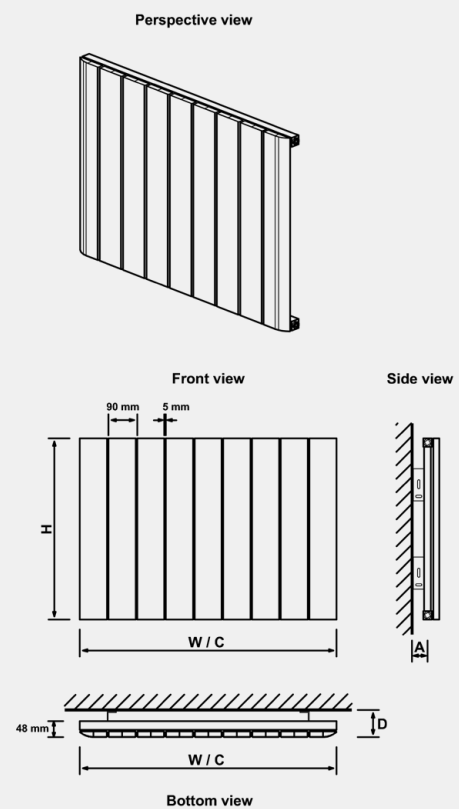

# Technical Tables & Drawings

## SANDHURST - ALUMINIUM RANGE

### Sandhurst - Vertical

Height H (mm)	Width W (mm)	Tappings C1 / C2** (mm)	Distance from wall - D (mm)	Tappings from wall - A (mm)	Tube Qty	Water Content L	Weight KG	Colour	▲T60		Element Output	Element Type
									Watts	BTU		
1800	275	275/210	105	65	4	1.60	7.50	Coloured	901	3074	450W	A, A+
1800	415	415/350	105	65	6	2.40	11.20	Coloured	1351	4611	750W	A, A+
1800	485	485/420	105	65	7	2.80	13.10	Coloured	1577	5380	900W	A, A+

\* Polished Aluminium heat outputs approx. 3% lower than the coloured models.

\*\* Tappings C1 : Side connection, Tappings C2 : Bottom connection.

### Sandhurst - Horizontal

Height H (mm)	Width W (mm)	Tappings C (mm)	Distance from wall - D (mm)	Tappings from wall - A (mm)	Tube Qty	Water Content L	Weight KG	Colour	▲T60		Element Output	Element Type
									Watts	BTU		
600	485	485	105	65	7	1.12	12.40	Coloured	526	1793	300W	A, A+
600	625	625	105	65	9	1.44	15.90	Coloured	676	2306	300W	A, A+
600	835	835	105	65	12	1.91	21.20	Coloured	901	3074	450W	A, A+
600	1045	1045	105	65	15	2.39	26.50	Coloured	1126	3843	600W	A, A+
600	1255	1255	105	65	18	2.86	31.80	Coloured	1351	4611	750W	A, A+

## BERKELEY - ALUMINIUM RANGE

### Berkeley - Horizontal

Height H (mm)	Width W (mm)	Tappings C (mm)	Distance from wall - D (mm)	Tappings from wall - A (mm)	Tube Qty	Water Content L	Weight KG	Colour	▲T60		Element Output	Element Type
									Watts	BTU		
603	600	600	70	50	6	1.30	5.70	Coloured	425	1451	N/A	N/A
603	800	800	70	50	6	1.70	5.80	Coloured	558	1904	N/A	N/A
603	1000	1000	70	50	6	2.00	6.33	Coloured	690	2355	N/A	N/A
603	1200	1200	70	50	6	2.40	7.22	Coloured	820	2798	N/A	N/A
603	1400	1400	70	50	6	2.80	8.80	Coloured	949	3238	N/A	N/A
603	1600	1600	70	50	6	3.10	9.60	Coloured	1077	3675	N/A	N/A
603	1800	1800	70	50	6	3.50	10.50	Coloured	1204	4109	N/A	N/A
603	2000	2000	70	50	6	3.80	11.30	Coloured	1330	4538	N/A	N/A

## TORDINO - ALUMINIUM RANGE

### Tordino - Vertical

Height H (mm)	Width W (mm)	Tappings C (mm)	Distance from wall - D (mm)	Tappings from wall - A (mm)	Tube Qty	Water Content L	Weight KG	Colour	▲T60		Element Output	Element Type
									Watts	BTU		
1800	280	280	80/100	31/51	3	1.70	6.50	Coloured	864	2948	450W	A, A+, F, G
1800	375	375	80/100	31/51	4	2.30	8.60	Coloured	1149	3921	600W	A, A+, F, G
1800	470	470	80/100	31/51	5	2.90	10.40	Coloured	1432	4886	750W	A, A+, F, G
1800	565	565	80/100	31/51	6	3.50	12.50	Coloured	1713	5845	1000W	A, A+, F, G



Sandhurst  
Vertical



Sandhurst  
Horizontal



Berkeley  
Horizontal



Tordino  
Vertical

# Technical Tables & Drawings

## SANDHURST - VERTICAL

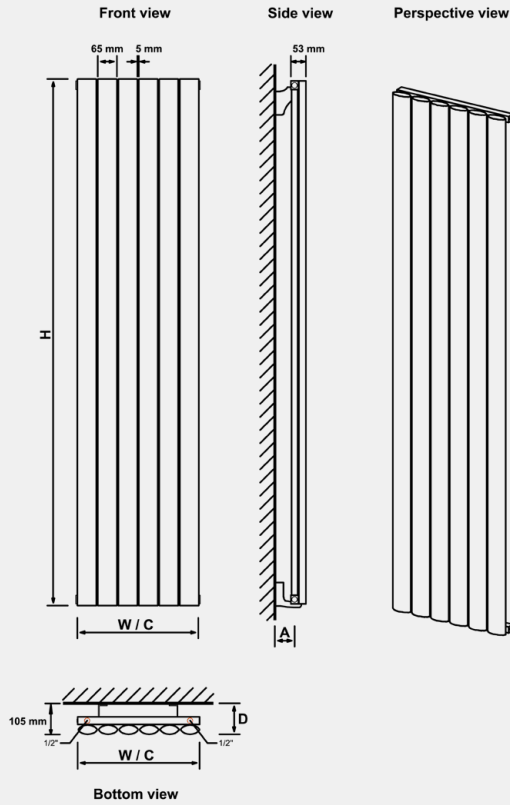

## SANDHURST - HORIZONTAL

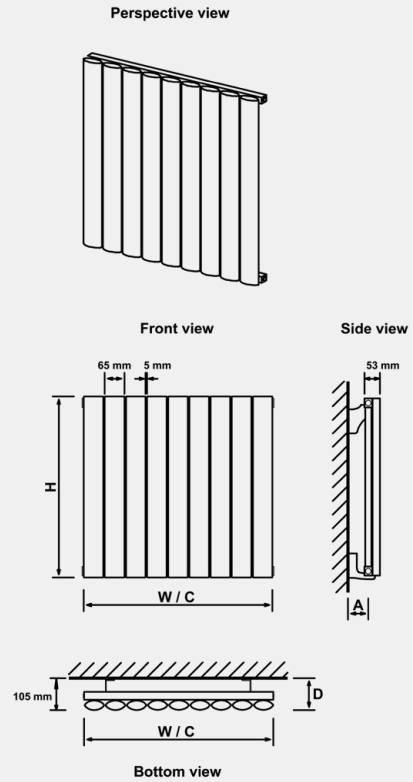

## BERKELEY - HORIZONTAL

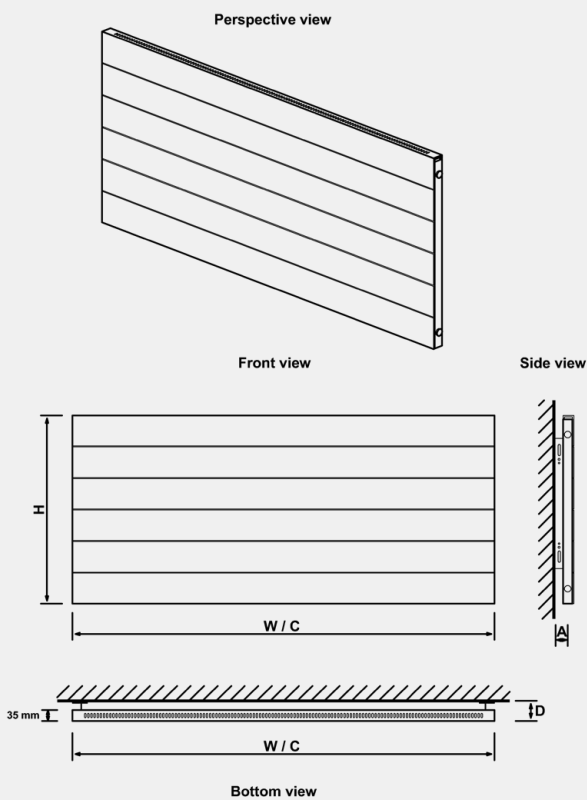

## TORDINO - VERTICAL

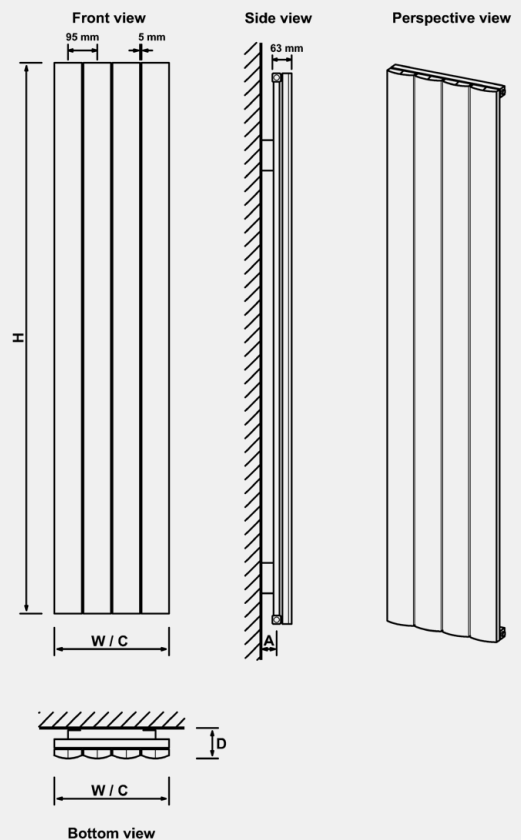

# Technical Tables & Drawings

## TORDINO - ALUMINIUM RANGE

### Tordino - Horizontal

Height H (mm)	Width W (mm)	Tappings C (mm)	Distance from wall - D (mm)	Tappings from wall - A (mm)	Tube Qty	Water Content L	Weight KG	Colour	▲T60		Element Output	Element Type
									Watts	BTU		
600	470	470	80/100	31/51	5	1.10	4.30	Coloured	520	1775	300W	A, A+, C, H
600	660	660	80/100	31/51	7	1.50	6.00	Coloured	724	2471	450W	A, A+, C, H
600	850	850	80/100	31/51	9	2.00	7.80	Coloured	927	3163	600W	A, A+, C, H
600	1040	1040	80/100	31/51	11	2.40	9.50	Coloured	1129	3853	750W	A, A+, C, H
600	1230	1230	80/100	31/51	13	2.80	11.20	Coloured	1329	4535	900W	A, A+, C, H

## GUARDIA - ALUMINIUM RANGE

### Guardia - Vertical

Height H (mm)	Width W (mm)	Tappings C (mm)	Distance from wall - D (mm)	Tappings from wall - A (mm)	Tube Qty	Water Content L	Weight KG	Colour	▲T60		Element Output	Element Type
									Watts	BTU		
1200	280	280	110	65	3	1.14	9.16	Coloured	960	3276	N/A	N/A
1200	375	375	110	65	4	1.52	12.12	Coloured	1280	4367	N/A	N/A
1200	470	470	110	65	5	1.90	15.05	Coloured	1600	5459	N/A	N/A
1200	565	565	110	65	6	2.27	18.24	Coloured	1920	6551	N/A	N/A
1800	280	280	110	65	3	1.75	14.2	Coloured	1368	4668	N/A	N/A
1800	375	375	110	65	4	2.33	18.7	Coloured	1824	6224	N/A	N/A
1800	470	470	110	65	5	2.91	23.1	Coloured	2280	7780	N/A	N/A
1800	565	565	110	65	6	3.50	27.80	Coloured	2736	9335	N/A	N/A

## GUARDIA - ALUMINIUM RANGE

### Guardia - Horizontal

Height H (mm)	Width W (mm)	Tappings C (mm)	Distance from wall - D (mm)	Tappings from wall - A (mm)	Tube Qty	Water Content L	Weight KG	Colour	▲T60		Element Output	Element Type
									Watts	BTU		
600	470	470	110	65	5	0.96	9.0	Coloured	800	2730	450W	A, A+, C, H
600	660	660	110	65	7	1.34	12.2	Coloured	1120	3822	600W	A, A+, C, H
600	850	850	110	65	9	1.73	15.6	Coloured	1440	4913	750W	A, A+, C, H
600	1040	1040	110	65	11	2.11	19.0	Coloured	1790	6005	1000W	A, A+, H
600	1230	1230	110	65	13	2.50	22.3	Coloured	2080	7097	1200W	A, A+
600	1420	1420	110	65	15	2.88	25.8	Coloured	2400	8190	1200W	A, A+

## HADLEIGH - ALUMINIUM RANGE

### Hadleigh - Vertical

Height H (mm)	Width W (mm)	Tappings C (mm)	Distance from wall - D (mm)	Tappings from wall - A (mm)	Tube Qty	Water Content L	Weight KG	Colour	▲T60		Element Output	Element Type
									Watts	BTU		
1200	275	275	98	65	4	1.52	9.56	Coloured	779	2658	N/A	N/A
1200	415	415	98	65	6	2.27	14.17	Coloured	1169	3987	N/A	N/A
1200	485	485	98	65	7	2.65	15.82	Coloured	1363	4652	N/A	N/A
1200	555	555	98	65	8	3.03	17.92	Coloured	1558	5316	N/A	N/A
1800	275	275	98	65	4	1.6	12.2	Coloured	1003	3422	N/A	N/A
1800	415	415	98	65	6	2.4	18.3	Coloured	1504	5132	N/A	N/A
1800	485	485	98	65	7	2.8	21.3	Coloured	1755	5988	N/A	N/A
1800	555	555	98	65	8	4.39	26.18	Coloured	2006	6843	N/A	N/A



Tordino  
Horizontal



Guardia  
Vertical



Guardia  
Horizontal



Hadleigh  
Vertical

# Technical Tables & Drawings

## TORDINO - HORIZONTAL

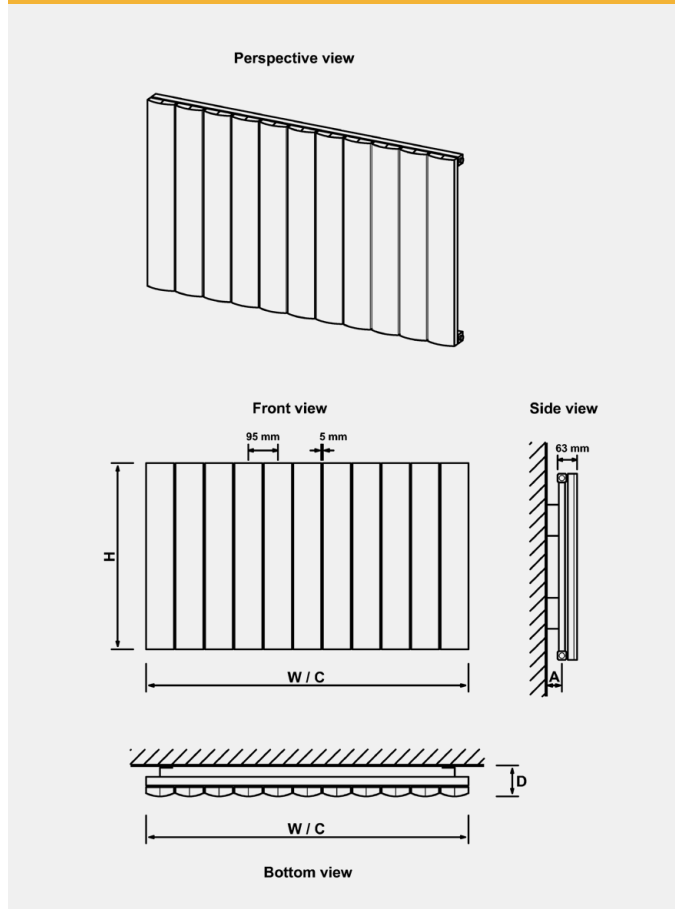

## GUARDIA - VERTICAL

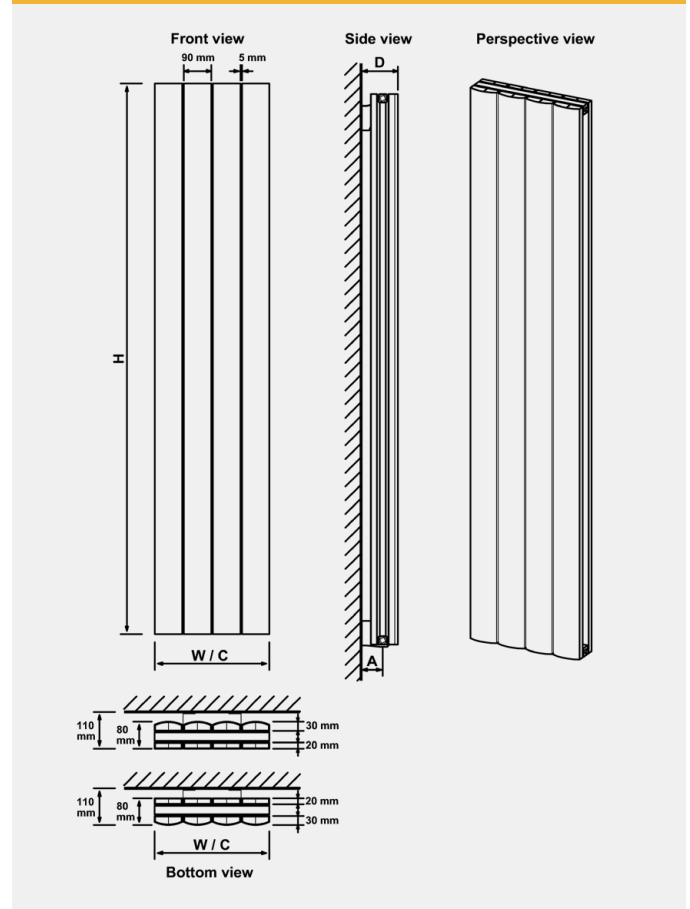

## GUARDIA - HORIZONTAL

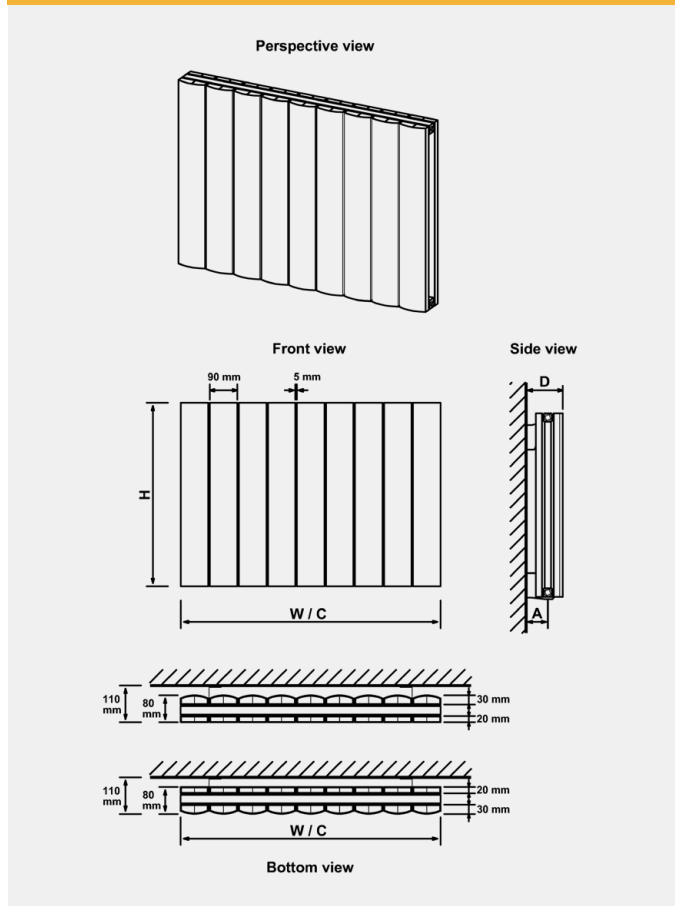

## HADLEIGH - VERTICAL

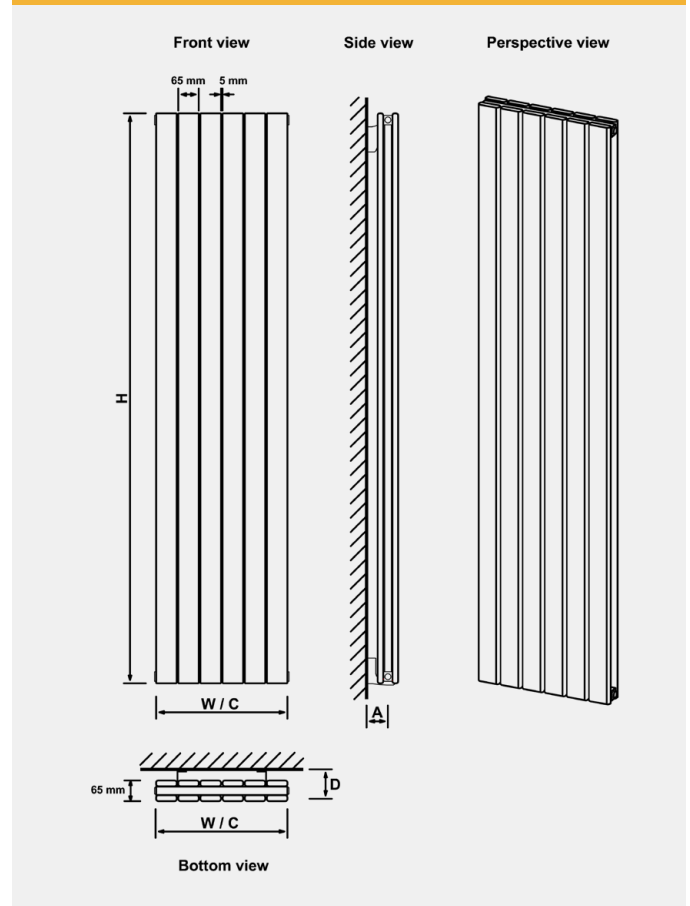

# Technical Tables & Drawings

## HADLEIGH - ALUMINIUM RANGE

### Hadleigh - Horizontal

Height H (mm)	Width W (mm)	Tappings C (mm)	Distance from wall - D (mm)	Tappings from wall - A (mm)	Tube Qty	Water Content L	Weight KG	Colour	▲T60		Element Output	Element Type
									Watts	BTU		
600	485	485	98	65	7	1.12	8.90	Coloured	821	2801	450W	A, A+, C, H
600	625	625	98	65	9	1.44	11.40	Coloured	1055	3601	600W	A, A+, C, H
600	835	835	98	65	12	1.91	15.20	Coloured	1407	4802	750W	A, A+, C, H
600	1045	1045	98	65	15	2.39	19.00	Coloured	1759	6002	1000W	A, A+, C, H
600	1255	1255	98	65	18	2.86	22.80	Coloured	2111	7202	1200W	A, A+, C, H
600	1395	1395	98	65	20	4.18	24.61	Coloured	2345	8003	1200W	A, A+, C, H

## VESIMA - ALUMINIUM RANGE

### Vesima - Vertical

Height H (mm)	Width W (mm)	Tappings C (mm)	Distance from wall - D (mm)	Tappings from wall - A (mm)	Tube Qty	Water Content L	Weight KG	Colour	▲T60		Element Output	Element Type
									Watts	BTU		
1800	303	303	85/105	60/80	3	1.75	10.90	Coloured	1068	3644	600W	A
1800	403	403	85/105	60/80	4	2.34	14.20	Coloured	1424	4859	900W	A
1800	503	503	85/105	60/80	5	2.92	17.60	Coloured	1780	6074	900W	A
1800	603	603	85/105	60/80	6	3.30	20.99	Coloured	2134	7282	900W	A

### Vesima - Horizontal

Height H (mm)	Width W (mm)	Tappings C (mm)	Distance from wall - D (mm)	Tappings from wall - A (mm)	Tube Qty	Water Content L	Weight KG	Colour	▲T60		Element Output	Element Type
									Watts	BTU		
600	503	503	85/105	60/80	5	0.97	7.10	Coloured	660	2252	300W	A, C, H
600	603	603	85/105	60/80	6	1.16	8.40	Coloured	792	2702	300W	A, C, H
600	803	803	85/105	60/80	8	1.55	10.90	Coloured	1056	3603	600W	A, C, H
600	1003	1003	85/105	60/80	10	1.94	13.50	Coloured	1320	4504	600W	A, C, H
600	1203	1203	85/105	60/80	12	2.33	16.10	Coloured	1584	5405	900W	A, C, H
600	1403	1403	85/105	60/80	14	2.93	18.54	Coloured	1844	6293	900W	A, C, H

## PRESTON - ALUMINIUM RANGE

### Preston - Vertical

Height H (mm)	Width W (mm)	Tappings C (mm)	Distance from wall - D (mm)	Tappings from wall - A (mm)	Tube Qty	Water Content L	Weight KG	Colour	▲T60		Element Output	Element Type
									Watts	BTU		
1200	185	185	71-91	33-53	2	1.20	5.80	Coloured	374	1277	150W	A, A+, F, G
1800	185	185	71-91	33-53	2	1.20	5.60	Coloured	540	1843	300W	A, A+, F, G

## BERLINI - ALUMINIUM RANGE

### Berlini - Vertical

Height H (mm)	Width W (mm)	Tappings C (mm)	Distance from wall - D (mm)	Tappings from wall - A (mm)	Tube Qty	Water Content L	Weight KG	Colour	▲T60		Element Output	Element Type
									Watts	BTU		
1200	185	185	70/90	35/55	2	0.78	5.60	Coloured	421	1438	150W	A, A+
1800	185	185	70/90	35/55	2	1.16	6.60	Coloured	632	2156	300W	A, A+

\*Polished Aluminium heat outputs approx 3% lower than the coloured models.



Hadleigh  
Horizontal



Vesima  
Vertical



Vesima  
Horizontal



Preston  
Vertical

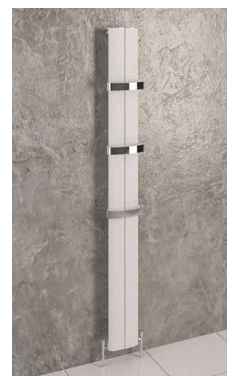

Berlini  
Vertical



# Technical Tables & Drawings

## HADLEIGH - HORIZONTAL

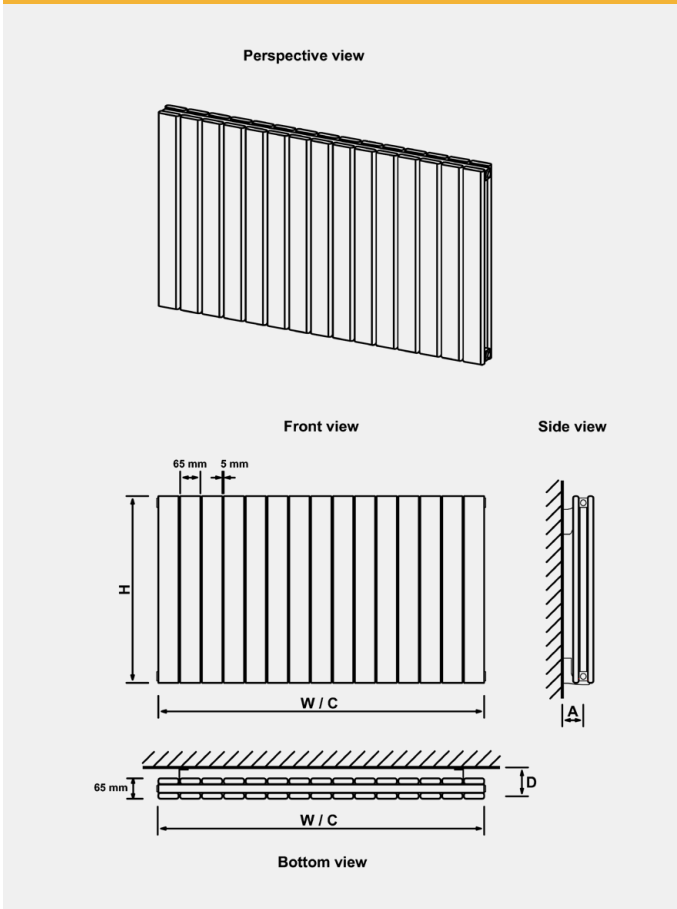

## VESIMA - VERTICAL

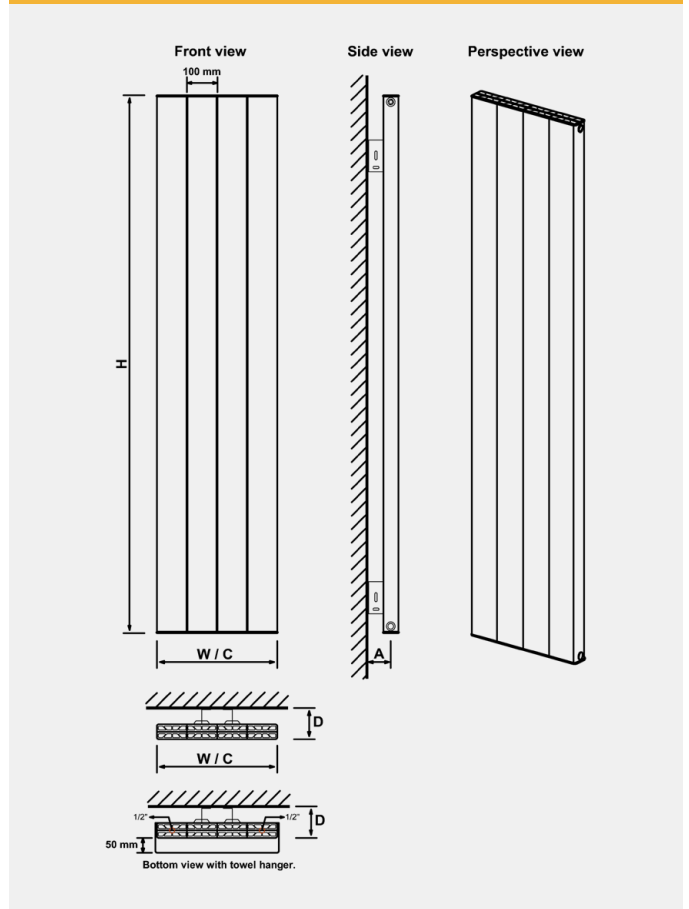

## VESIMA - HORIZONTAL

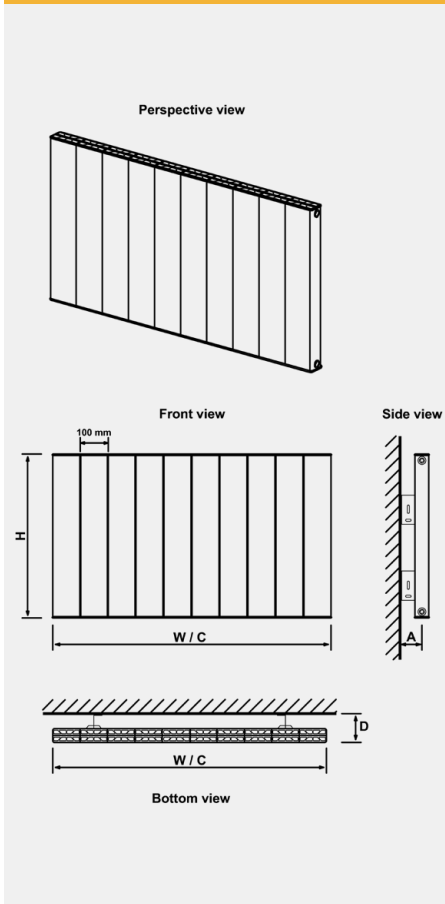

## PRESTON - VERTICAL

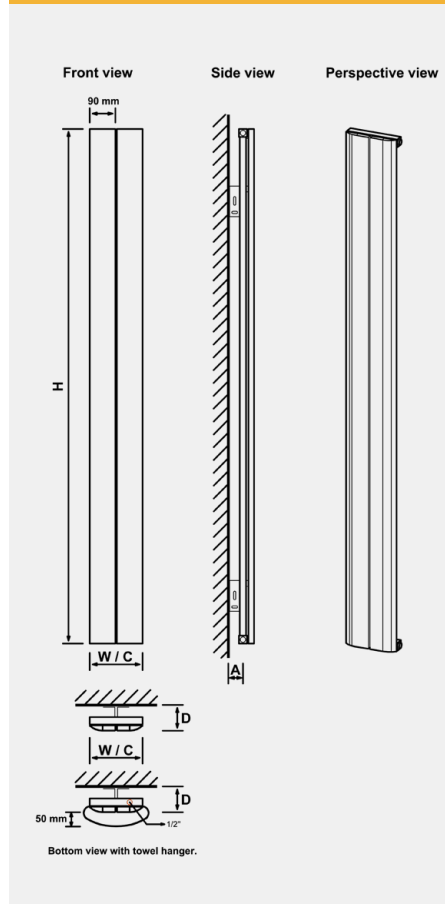

## BERLINI - VERTICAL

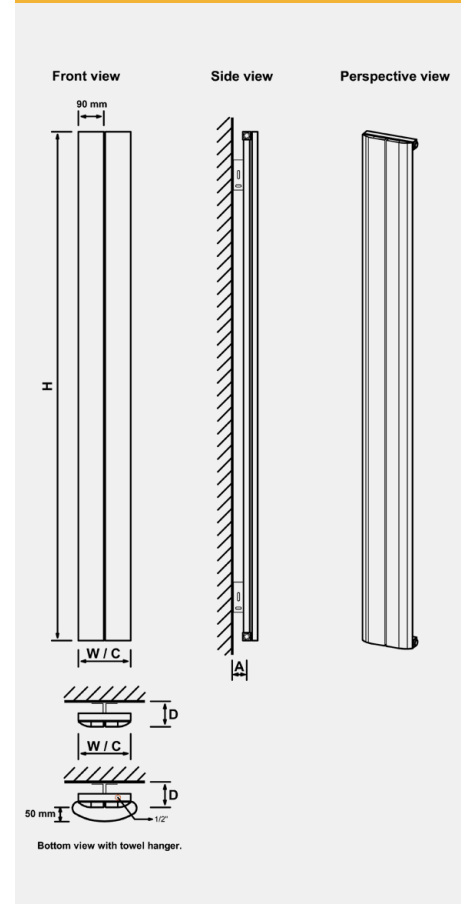

# Technical Tables & Drawings

## FAIRFORD - ALUMINIUM RANGE

### Fairford - Vertical

Height H (mm)	Width W (mm)	Tappings C (mm)	Distance from wall - D (mm)	Tappings from wall - A (mm)	Tube Qty	Water Content L	Weight KG	Colour	▲T60		Element Output	Element Type
									Watts	BTU		
1200	375	375	79/99	33/53	4	1.60	7.20	Coloured	760	2594	450W	A, A+, F, G
1200	565	565	79/99	33/53	6	2.40	11.00	Coloured	1144	3904	750W	A, A+, F, G
1800	375	375	79/99	33/53	4	2.33	9.90	Coloured	1140	3890	750W	A, A+, F, G
1800	565	565	79/99	33/53	6	3.50	13.80	Coloured	1716	5855	1000W	A, A+, F, G

### Fairford - Horizontal

Height H (mm)	Width W (mm)	Tappings C (mm)	Distance from wall - D (mm)	Tappings from wall - A (mm)	Tube Qty	Water Content L	Weight KG	Colour	▲T60		Element Output	Element Type
									Watts	BTU		
600	375	375	79/99	33/53	4	0.87	4.50	Coloured	392	1338	300W	A, A+
600	565	565	79/99	33/53	6	1.30	6.70	Coloured	591	2017	300W	A, A+, C, H
600	945	945	79/99	33/53	10	2.18	10.10	Coloured	987	3368	600W	A, A+, C, H
600	1325	1325	79/99	33/53	14	3.06	13.90	Coloured	1382	4716	900W	A, A+, C, H

## BURFORD - ALUMINIUM RANGE

### Burford - Vertical

Height H (mm)	Width W (mm)	Tappings C (mm)	Distance from wall - D (mm)	Tappings from wall - A (mm)	Tube Qty	Water Content L	Weight KG	Colour	▲T60		Element Output	Element Type
									Watts	BTU		
1800	275	275	108/128	33/53	4	2.28	10.4	Coloured	972	3317	600W	A, A+, F, G
1800	345	345	108/128	33/53	5	2.85	12.9	Coloured	1209	4126	750W	A, A+, F, G
1800	415	415	108/128	33/53	6	3.42	15.3	Coloured	1443	4924	900W	A, A+, F, G
1800	485	485	108/128	33/53	7	3.99	17.7	Coloured	1676	5719	1000W	A, A+, F, G

### Burford - Horizontal

Height H (mm)	Width W (mm)	Tappings C (mm)	Distance from wall - D (mm)	Tappings from wall - A (mm)	Tube Qty	Water Content L	Weight KG	Colour	▲T60		Element Output	Element Type
									Watts	BTU		
600	485	485	108/128	33/53	7	1.43	7.3	Coloured	606	2068	300W	A, A+, C, H
600	625	625	108/128	33/53	9	1.84	9.2	Coloured	772	2635	450W	A, A+, C, H
600	835	835	108/128	33/53	12	2.45	12.0	Coloured	1020	3481	600W	A, A+, C, H
600	1045	1045	108/128	33/53	15	3.07	14.8	Coloured	1265	4317	750W	A, A+, C, H
600	1185	1185	108/128	33/53	17	3.47	16.7	Coloured	1427	4869	900W	A, A+, C, H

## KELMSCOTT - ALUMINIUM RANGE

### Kelmscott - Vertical

Height H (mm)	Width W (mm)	Tappings C (mm)	Distance from wall - D (mm)	Tappings from wall - A (mm)	Tube Qty	Water Content L	Weight KG	Colour	▲T60		Element Output	Element Type
									Watts	BTU		
1800	275	275	83/103	33/53	4	2.28	8.2	Coloured	957	3266	600W	A, A+, F, G
1800	345	345	83/103	33/53	5	2.85	10.1	Coloured	1195	4078	750W	A, A+, F, G
1800	415	415	83/103	33/53	6	3.42	12.0	Coloured	1431	4883	900W	A, A+, F, G
1800	485	485	83/103	33/53	7	3.99	13.8	Coloured	1666	5685	1000W	A, A+, F, G



Fairford  
Vertical



Fairford  
Horizontal



Burford  
Vertical



Burford  
Horizontal



Kelmscott  
Vertical

# Technical Tables & Drawings

## FAIRFORD - VERTICAL

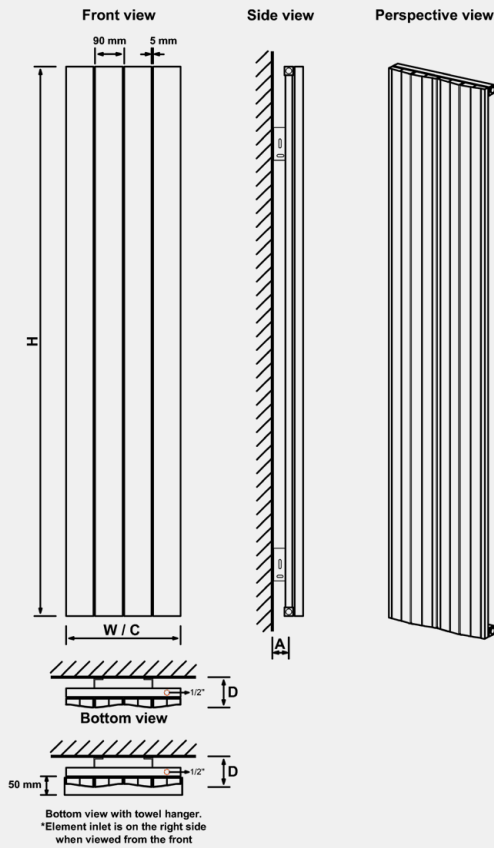

## FAIRFORD - HORIZONTAL

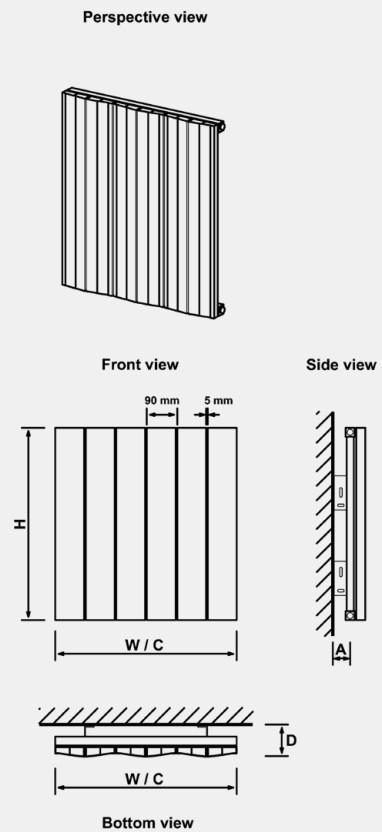

## BURFORD - VERTICAL

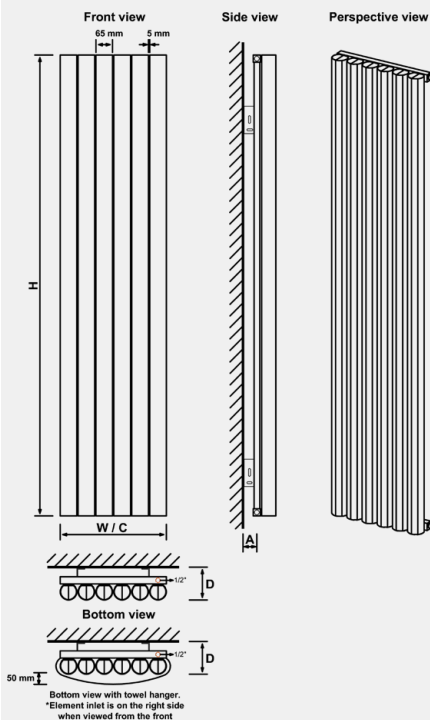

## BURFORD - HORIZONTAL

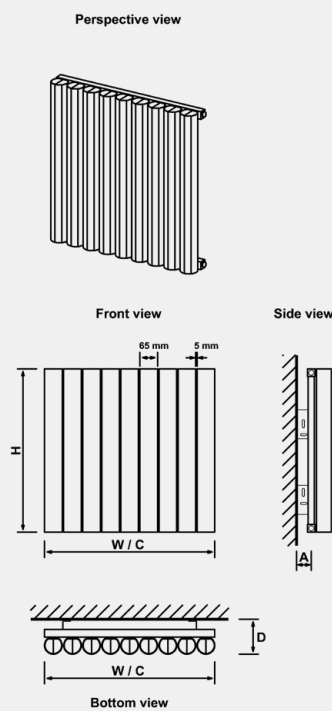

## KELMSCOTT - VERTICAL

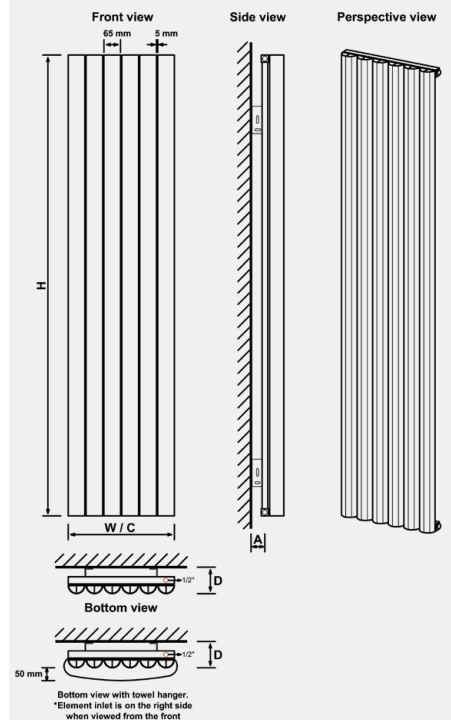

# Technical Tables & Drawings

## KELMSCOTT - ALUMINIUM RANGE

### Kelmscott - Horizontal

Height H (mm)	Width W (mm)	Tappings C (mm)	Distance from wall - D (mm)	Tappings from wall - A (mm)	Tube Qty	Water Content L	Weight KG	Colour	▲T60		Element Output	Element Type
									Watts	BTU		
600	485	485	83/103	33/53	7	1.43	6.0	Coloured	603	2058	300W	A, A+, C, H
600	625	625	83/103	33/53	9	1.84	7.5	Coloured	773	2638	450W	A, A+, C, H
600	835	835	83/103	33/53	12	2.45	9.8	Coloured	1025	3498	600W	A, A+, C, H
600	1045	1045	83/103	33/53	15	3.07	12.0	Coloured	1277	4358	750W	A, A+, C, H
600	1185	1185	83/103	33/53	17	3.47	13.5	Coloured	1444	4927	900W	A, A+, C, H

## WITNEY - ALUMINIUM RANGE

### Witney - Vertical

Height H (mm)	Width W (mm)	Tappings C (mm)	Distance from wall - D (mm)	Tappings from wall - A (mm)	Tube Qty	Water Content L	Weight KG	Colour	▲T60		Element Output	Element Type
									Watts	BTU		
1800	280	280	136	53	6	3.34	14.4	Coloured	1252	4272	750W	A, A+, F, G
1800	375	375	136	53	8	4.46	18.9	Coloured	1648	5623	1000W	A, A+, F, G
1800	470	470	136	53	10	5.57	23.4	Coloured	2039	6958	1200W	A, A+, F, G

### Witney - Horizontal

Height H (mm)	Width W (mm)	Tappings C (mm)	Distance from wall - D (mm)	Tappings from wall - A (mm)	Tube Qty	Water Content L	Weight KG	Colour	▲T60		Element Output	Element Type
									Watts	BTU		
600	470	470	136	53	10	1.90	7.5	Coloured	823	2809	300W	A, A+, C, H
600	660	660	136	53	14	2.70	10.5	Coloured	1132	3863	600W	A, A+, C, H
600	850	850	136	53	18	3.50	13.5	Coloured	1437	4904	900W	A, A+, C, H
600	1040	1040	136	53	22	4.20	16.6	Coloured	1737	5927	1000W	A, A+, C, H
600	1230	1230	136	53	26	5.00	19.6	Coloured	2034	6941	1200W	A, A+, C, H

## WINDRUSH - TRADITIONAL RANGE

### Windrush

Height H (mm)	Width W (mm)	Tappings C (mm)	Distance from wall - D (mm)	Tappings from wall - A (mm)	Tube Qty	Water Content L	Weight KG	Colour	▲T60		Element Output	Element Type
									Watts	BTU		
950	500	356	142	105	-	2.10	5.70	Chrome	147	502	100W	A, A+
950	600	470	142	105	-	2.27	6.40	Chrome	163	556	100W	A, A+
1195	500	370	130	105	-	2.70	7.40	Chrome	236	805	150W	A, A+, E
1195	600	470	130	105	-	3.00	7.80	Chrome	258	880	150W	A, A+, E
1550	500	370	130	105	-	3.50	8.70	Chrome	290	989	150W	A, A+, E
1550	600	470	130	105	-	3.80	9.25	Chrome	322	1099	150W	A, A+, E

## STOUR - TRADITIONAL RANGE

### Stour

Height H (mm)	Width W (mm)	Tappings C (mm)	Distance from wall - D (mm)	Tappings from wall - A (mm)	Tube Qty	Water Content L	Weight KG	Colour	▲T60		Element Output	Element Type	Colour	▲T60		Element Output	Element Type
									Watts	BTU				Watts	BTU		
690	500	426	125	53	-	1.30	5.50	Coloured	221	753	100W	A, A+, E	Chrome / Brushed Brass	125	428	N/A	N/A
690	600	526	125	53	-	2.10	5.60	Coloured	240	820	100W	A, A+, E	Chrome / Brushed Brass	177	604	100W	A, A+, E
1195	500	426	130	53	-	3.30	8.10	Coloured	287	979	100W	A, A+, E	Chrome / Brushed Brass	209	714	100W	A, A+, E
1195	600	526	130	53	-	3.70	8.47	Coloured	386	1318	150W	A, A+, E	Chrome / Brushed Brass	232	791	150W	A, A+, E
1550	500	426	130	53	-	3.80	9.40	Coloured	366	1248	150W	A, A+, E	Chrome / Brushed Brass	260	888	150W	A, A+, E
1550	600	526	130	53	-	4.10	9.86	Coloured	398	1359	150W	A, A+, E	Chrome / Brushed Brass	287	980	150W	A, A+, E



Kelmscott  
Horizontal



Witney  
Vertical



Witney  
Horizontal



Windrush



Stour

# Technical Tables & Drawings

## KELMSCOTT - HORIZONTAL

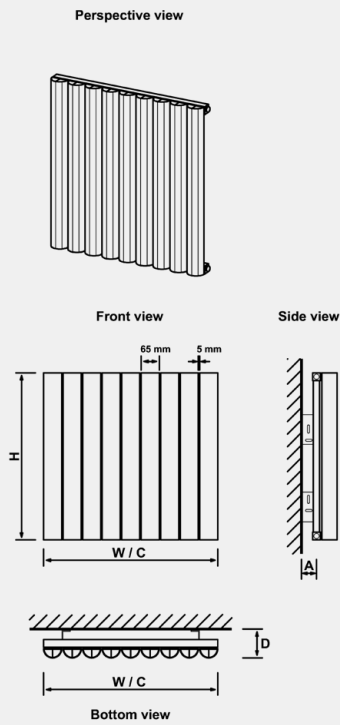

## WITNEY - VERTICAL

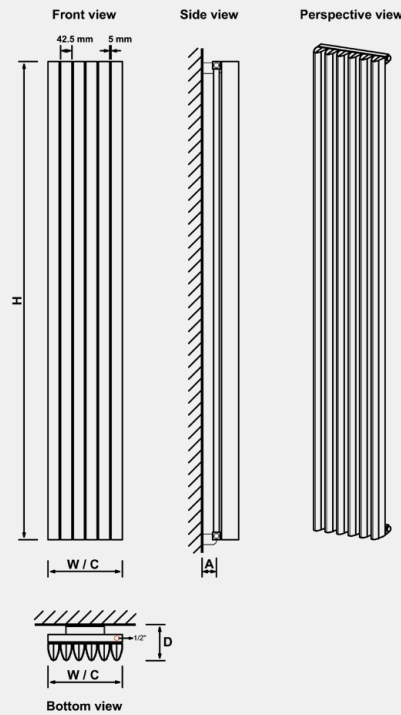

## WITNEY - HORIZONTAL

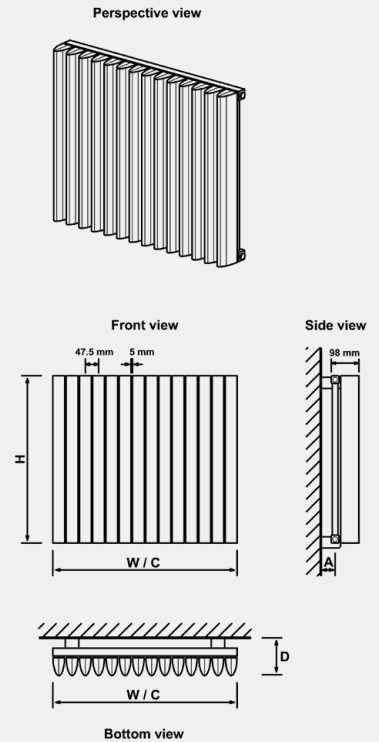

## WINDRUSH

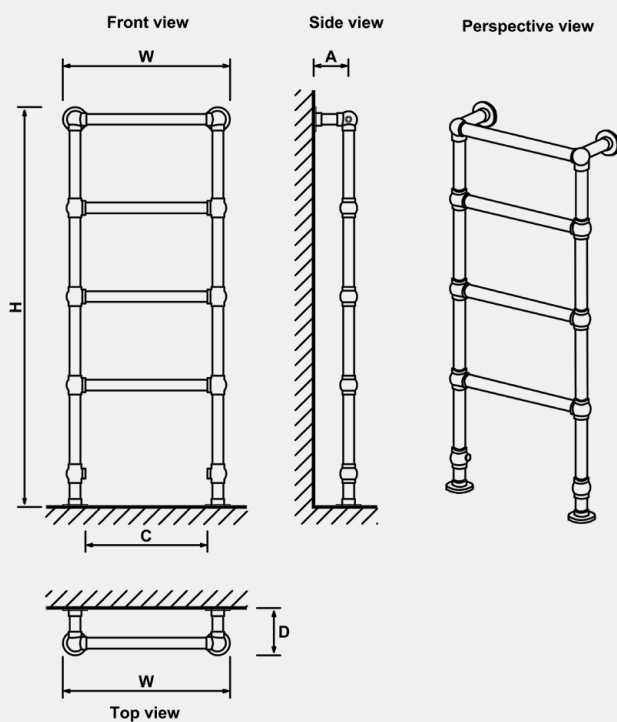

## STOUR

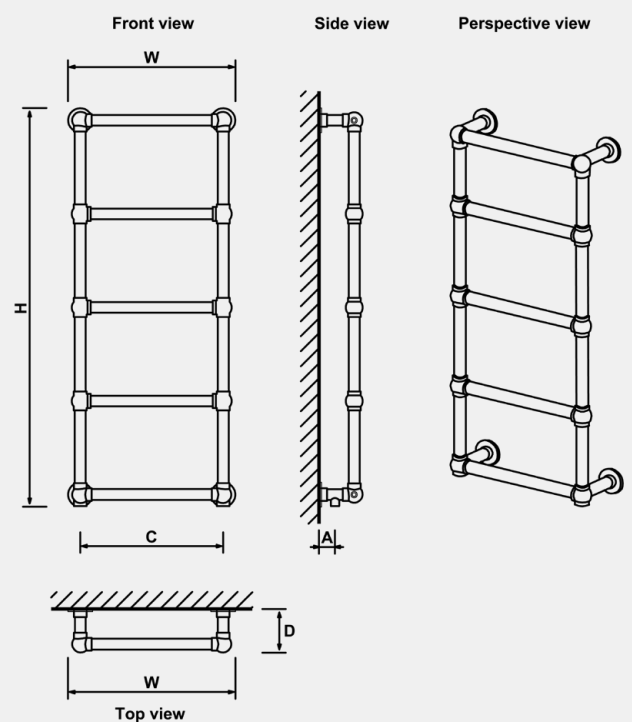

# Technical Tables & Drawings

## PAINSWICK - TRADITIONAL RANGE

Painswick													
Height H (mm)	Width W (mm)	Tappings C (mm)	Depth - D (mm)	Tappings from floor- A (mm)	Tube Qty	Water Content L	Weight KG	Colour	▲T60		Element Output	Element Type	
									Watts	BTU			
778	686	556	254	100	-	3.51	11.50	Chrome	356	1215	N/A	N/A	

## FROME - TRADITIONAL RANGE

Frome													
Height H (mm)	Width W (mm)	Tappings C (mm)	Distance from Wall - D (mm)	Tappings from wall- A (mm)	Tube Qty	Water Content L	Weight KG	Colour	▲T60		Element Output	Element Type	
									Watts	BTU			
940	474	344	130	105	-	4.90	7.45	Chrome	314	1071	150W	A, A+, C, E, H	

## SHERBOURNE - TRADITIONAL RANGE

Sherbourne													
Height H (mm)	Width W (mm)	Tappings C (mm)	Distance from Wall - D (mm)	Tappings from wall- A (mm)	Tube Qty	Water Content L	Weight KG	Colour	▲T60		Element Output	Element Type	
									Watts	BTU			
940	600	470	142	105	-	3.50	7.24	Chrome	226	771	150W	A, A+, C, E, H	

## AVON - TRADITIONAL RANGE

Avon													
Height H (mm)	Width W (mm)	Tappings C (mm)	Distance from Wall - D (mm)	Tappings from wall - A (mm)	Tube Qty	Water Content L	Weight KG	Colour	▲T60		Element Output	Element Type	
									Watts	BTU			
960	429	300	160	135	-	4.30	15.5	Chrome	450	1535	150W	A, A+, C, E, H	
960	500	370	172	135	-	5.50	15.7	Chrome	530	1808	300W	A, A+, C, E, H	

## ISBOURNE - TRADITIONAL RANGE

Isbourne													
Height H (mm)	Width W (mm)	Tappings C (mm)	Distance from Wall - D (mm)	Tappings from wall - A (mm)	Tube Qty	Water Content L	Weight KG	Colour	▲T60		Element Output	Element Type	
									Watts	BTU			
940	600	470	260	121	-	6.62	16.70	Chrome	894	3050	450W	A, A+, C, H	



Painswick



Frome



Sherbourne



Isbourne



Avon

# Technical Tables & Drawings

## PAINSWICK

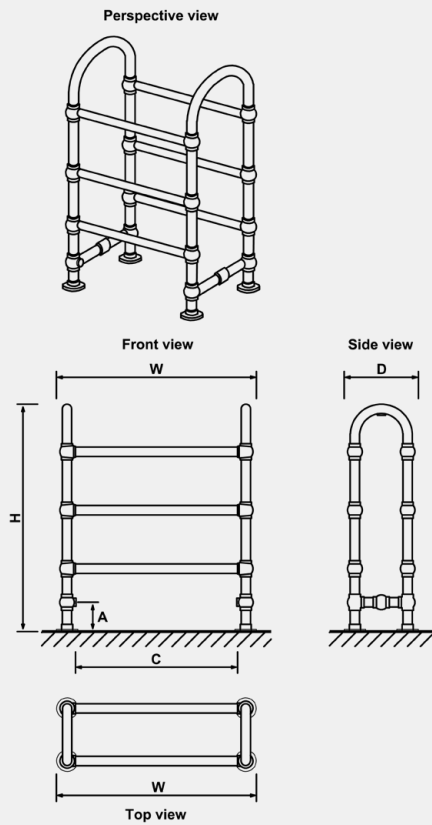

## FROME

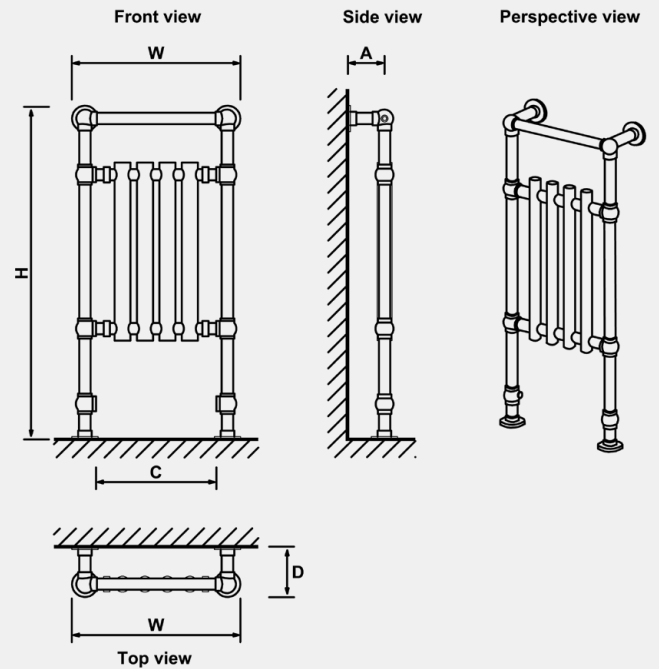

## SHERBOURNE

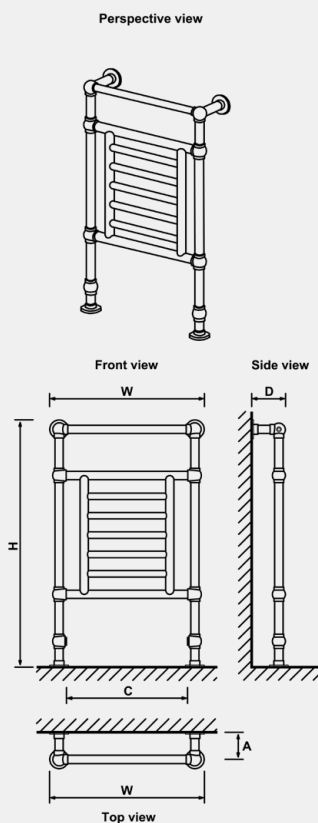

## ISBOURNE

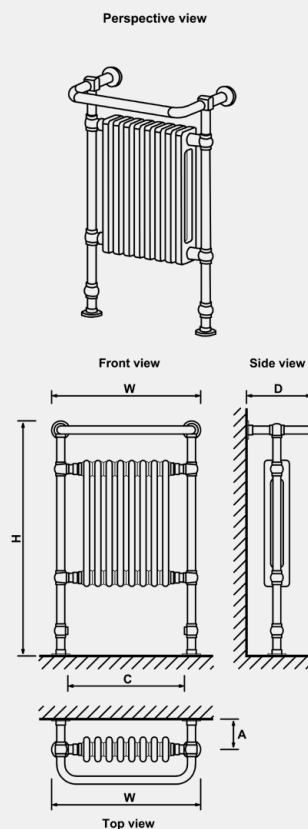

## AVON

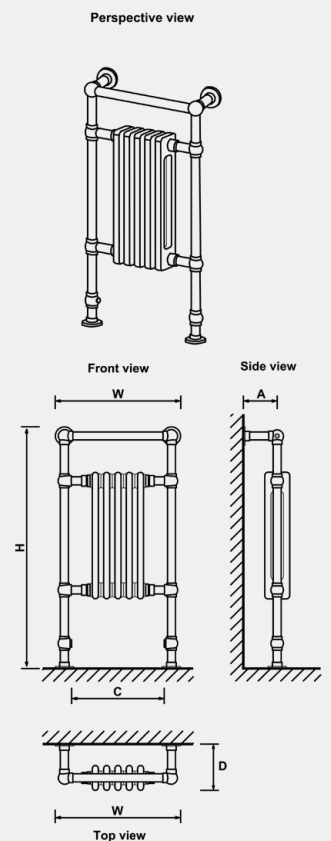

# Technical Tables & Drawings

## IMPERIA 2 COLUMN - TRADITIONAL RANGE

### Imperia 2 Column - Vertical / Horizontal

Height H (mm)	Width W (mm)	Tappings C (mm)	Distance from Wall - D (mm)	Tappings from wall - A (mm)	Tube Qty	Water Content L	Weight KG	Colour	△T60		Element Output	Element Type
									Watts	BTU		
300	1145	1145	93	60	25	10.53	15.98	Coloured	875	2985	450W	A, A+, C, E*, H
300	1370	1370	93	60	30	12.60	19.00	Coloured	1048	3573	450W	A, A+, C, E*, H
600	425	425	93	60	9	5.74	11.57	Coloured	576	1965	300W	A, A+, C, H
600	470	470	93	60	10	6.38	12.72	Coloured	639	2180	300W	A, A+, C, H
600	515	515	93	60	11	7.01	13.93	Coloured	704	2402	300W	A, A+, C, H
600	560	560	93	60	12	7.65	15.09	Coloured	767	2617	300W	A, A+, C, H
600	605	605	93	60	13	7.60	15.05	Bare Metal/ Coloured	826	2818	450W	A, A+, C, H
600	830	830	93	60	18	10.60	20.49	Bare Metal/ Coloured	1143	3900	600W	A, A+, C, E*, H
600	1010	1010	93	60	22	14.03	26.68	Coloured	1407	4800	750W	A, A+, C, H
600	1145	1145	93	60	25	14.90	28.10	Bare Metal/ Coloured	1588	5418	900W	A, A+, H
600	1460	1460	93	60	32	20.41	38.30	Coloured	2046	6980	1000W	A+
1800	290	290	93	60	6	9.03	22.27	Coloured	1078	3678	N/A	N/A
1800	380	380	93	60	8	11.60	26.31	Bare Metal/ Coloured	1190	4059	N/A	N/A
1800	470	470	93	60	10	14.60	32.66	Bare Metal/ Coloured	1487	5074	N/A	N/A

\* 600W Type E Element can be fitted

## IMPERIA 3 COLUMN - TRADITIONAL RANGE

### Imperia 3 Column - Vertical / Horizontal

Height H (mm)	Width W (mm)	Tappings C (mm)	Distance from Wall - D (mm)	Tappings from wall - A (mm)	Tube Qty	Water Content L	Weight KG	Colour	△T60		Element Output	Element Type
									Watts	BTU		
300	1145	1145	110	60	25	11.88	26.24	Coloured	1278	4360	600W	A, A+, C, E*, H
300	1370	1370	110	60	30	14.21	50.77	Coloured	1436	4896	750W	A, A+, C, E*, H
600	425	425	110	60	9	7.20	16.31	Coloured	850	2900	450W	A, A+
600	470	470	110	60	10	8.00	17.99	Coloured	945	3224	450W	A, A+, C, H
600	515	515	110	60	11	8.80	19.71	Coloured	1040	3548	450W	A, A+, C, H
600	560	560	110	60	12	9.60	21.39	Coloured	1134	3869	600W	A+, C, H
600	605	605	110	60	13	11.00	21.63	Bare Metal/ Coloured	1081	3688	600W	A, A+, C, H
600	830	830	110	60	18	15.30	29.55	Bare Metal/ Coloured	1498	5110	900W	A+, C, H
600	1010	1010	110	60	22	17.60	38.15	Coloured	2079	7093	1000W	A, A+, C, H
600	1145	1145	110	60	25	21.30	40.64	Bare Metal/ Coloured	2362	8059	1200W	A, A+, H
600	1460	1460	110	60	32	25.61	54.94	Coloured	3024	10317	1200W	A+, H
1800	290	290	110	60	6	12.60	32.06	Coloured	1608	5486	N/A	N/A
1800	380	380	110	60	8	17.40	38.77	Bare Metal/ Coloured	2099	7094	N/A	N/A
1800	470	470	110	60	10	21.90	48.20	Bare Metal/ Coloured	2623	8950	N/A	N/A

\* 600W Type E Element can be fitted



Imperia 2 Column  
Vertical



Imperia 2 Column  
Horizontal



Imperia 3 Column  
Vertical



Imperia 3 Column  
Horizontal



# Technical Tables & Drawings

## IMPERIA 2 COLUMN VERTICAL

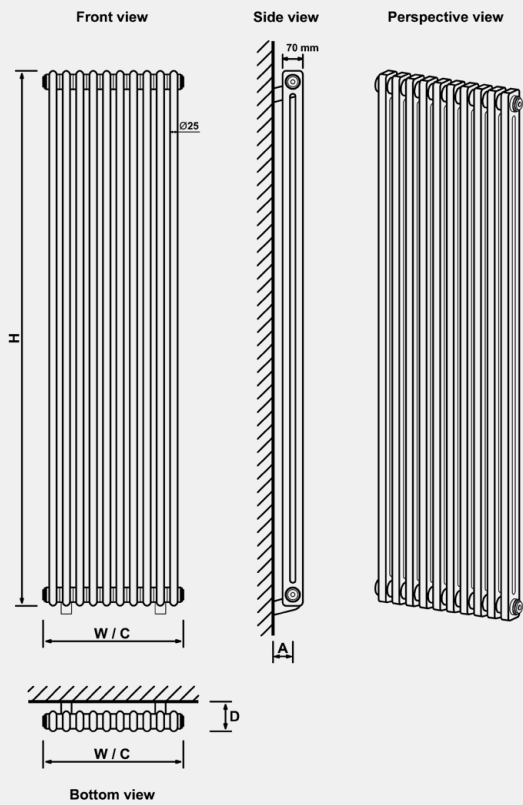

## IMPERIA 2 COLUMN HORIZONTAL

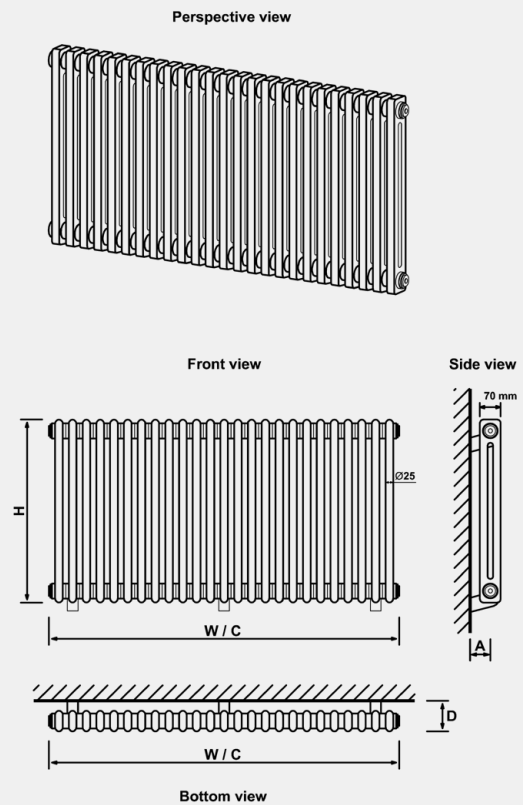

## IMPERIA 3 COLUMN VERTICAL

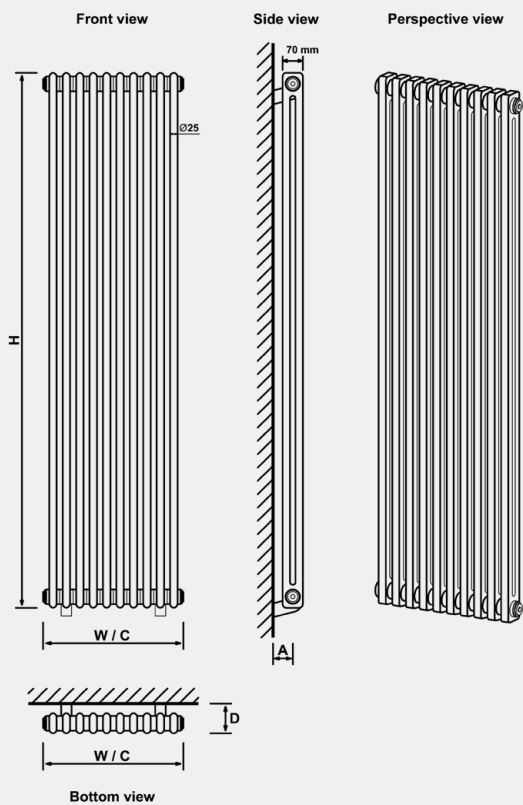

## IMPERIA 3 COLUMN HORIZONTAL

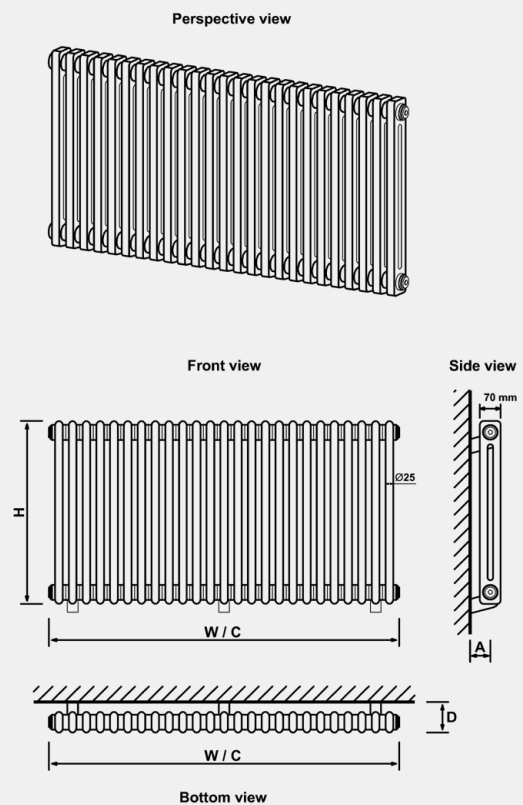

# Technical Tables & Drawings

## RIVASSA - TRADITIONAL RANGE

Rivassa 2 Column - Vertical / Horizontal												
Height H (mm)	Width W (mm)	Tappings C (mm)	Distance from Wall - D (mm)	Tappings from wall - A (mm)	Tube Qty	Water Content L	Weight KG	Colour	ΔT60		Element Output	Element Type
									Watts	BTU		
300	1148	1148	100	66	25	9.25	17.5	Coloured	889	3034	450W	A, A+, C, E*, H
300	1373	1373	100	66	30	11.10	20.8	Coloured	1067	3641	600W	A, A+, C, E*, H
600	428	428	100	66	9	5.40	10.5	Coloured	567	1933	300W	A, A+, C, H
600	473	473	100	66	10	6.00	11.7	Coloured	630	2148	300W	A, A+, C, H
600	518	518	100	66	11	6.60	12.8	Coloured	693	2362	300W	A, A+, C, H
600	563	563	100	66	12	7.20	14.0	Coloured	756	2577	450W	A, A+, C, H
600	608	608	100	66	13	7.80	18.2	Coloured	818	2792	450W	A, A+, C, H
600	833	833	100	66	18	10.80	23.9	Coloured	1133	3866	600W	A, A+, C, E*, H
600	1010	1010	100	66	22	13.20	28.50	Coloured	1385	4727	750W	A, A+, C, H
600	1148	1148	100	66	25	15.10	31.8	Coloured	1573	5369	900W	A, A+, H
600	1460	1460	100	66	32	19.20	39.70	Coloured	2014	6874	1200W	A, A+, H
1800	293	293	100	66	6	8.90	22.9	Coloured	933	3185	N/A	N/A
1800	383	383	100	66	8	11.80	29.7	Coloured	1245	4247	N/A	N/A
1800	473	473	100	66	10	14.80	36.9	Coloured	1556	5308	N/A	N/A

\*600w Type E Element can be fitted

Rivassa 3 Column - Vertical / Horizontal												
Height H (mm)	Width W (mm)	Tappings C (mm)	Distance from Wall - D (mm)	Tappings from wall - A (mm)	Tube Qty	Water Content L	Weight KG	Colour	ΔT60		Element Output	Element Type
									Watts	BTU		
300	1148	1148	130	80	25	14.10	25.2	Coloured	1118	3816	600W	A, A+, C, E*, H
300	1373	1373	130	80	30	16.80	30.2	Coloured	1342	4579	750W	A, A+, C, E*, H
600	428	428	130	80	9	7.70	15.2	Coloured	734	2504	450W	A, A+, C, H
600	473	473	130	80	10	8.60	16.8	Coloured	816	2782	450W	A, A+, C, H
600	518	518	130	80	11	9.50	18.5	Coloured	898	3061	450W	A, A+, C, H
600	563	563	130	80	12	10.30	20.1	Coloured	979	3339	600W	A, A+, C, H
600	608	608	130	80	13	11.20	24.4	Coloured	1060	3616	600W	A, A+, C, H
600	833	833	130	80	18	15.50	32.8	Coloured	1467	5007	900W	A, A+, C, H
600	1010	1010	130	80	22	18.90	40.30	Coloured	1794	6123	1000W	A, A+, C, H
600	1148	1148	130	80	25	21.50	45.6	Coloured	2038	6954	1200W	A, A+, H
600	1460	1460	130	80	32	27.50	58.10	Coloured	2609	8904	1200W	A, A+, H
1800	293	293	130	80	6	13.20	33.0	Coloured	1563	5333	N/A	N/A
1800	383	383	130	80	8	17.60	43.6	Coloured	2084	7111	N/A	N/A
1800	473	473	130	80	10	22.10	53.9	Coloured	2605	8889	N/A	N/A

\*600w Type E Element can be fitted



Rivassa 2 Column Vertical



Rivassa 2 Column Horizontal



Rivassa 3 Column Horizontal



Rivassa 3 Column Vertical

# Technical Tables & Drawings

## RIVASSA 2 COLUMN HORIZONTAL

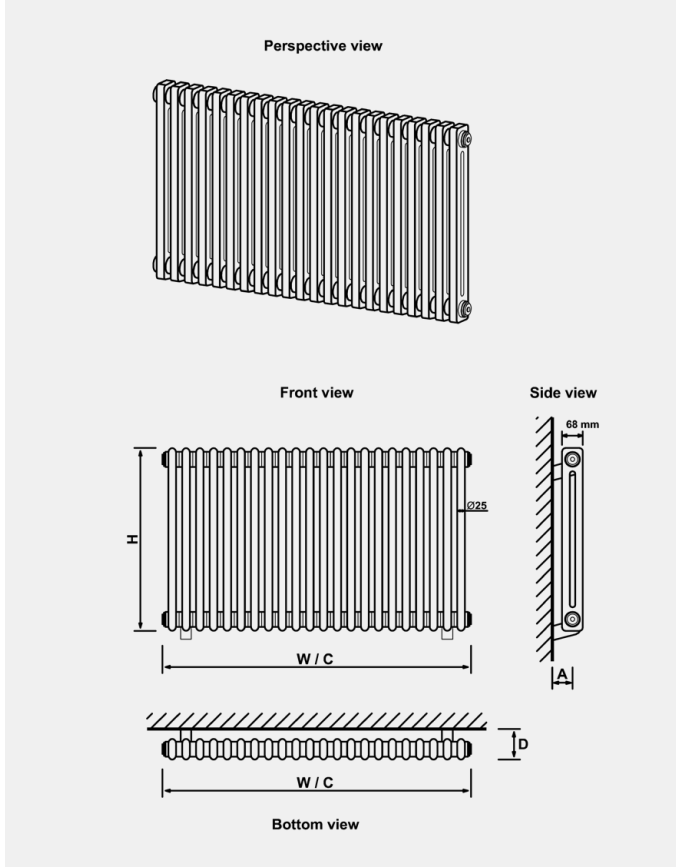

## RIVASSA 2 COLUMN VERTICAL

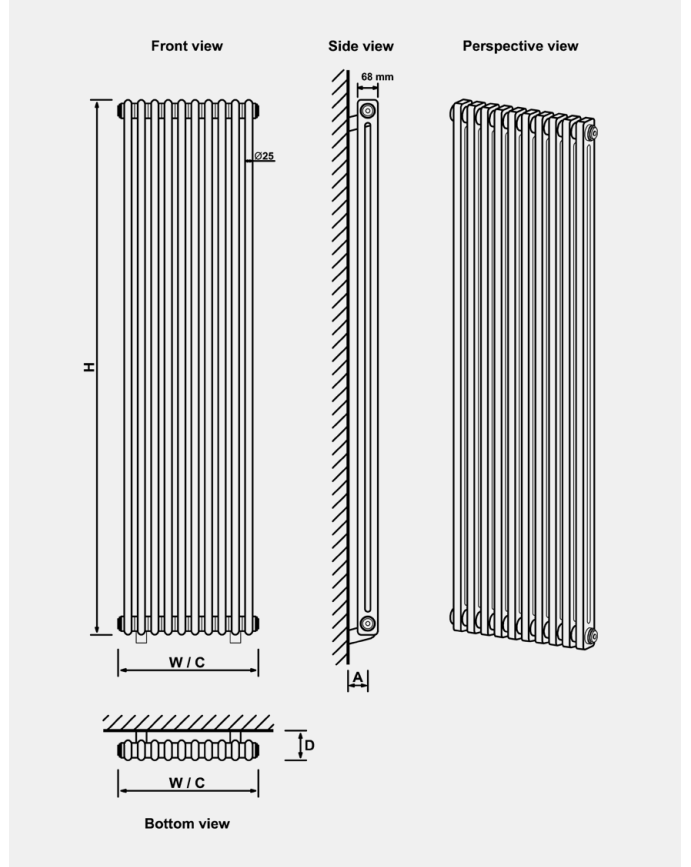

## RIVASSA 3 COLUMN HORIZONTAL

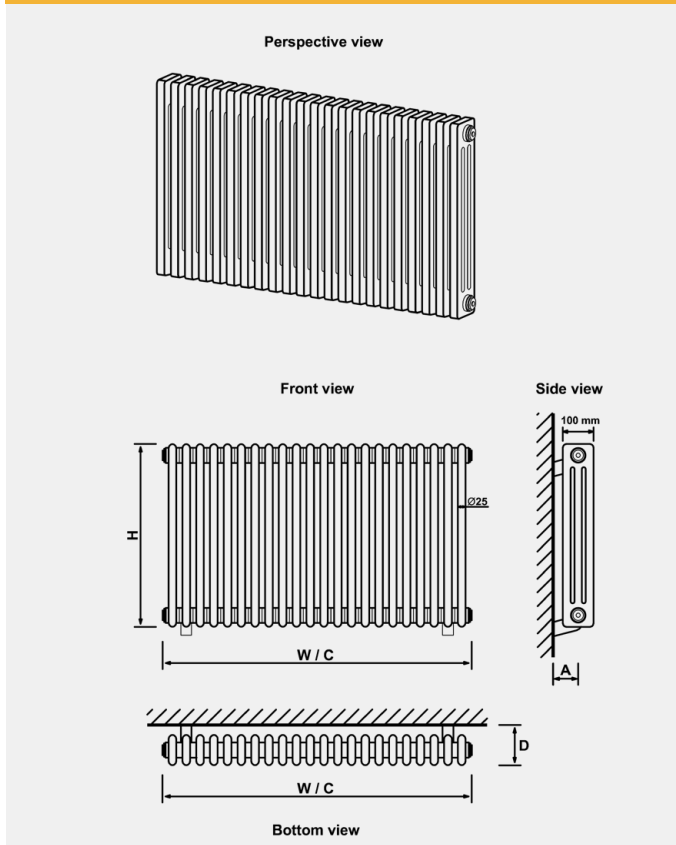

## RIVASSA 3 COLUMN VERTICAL

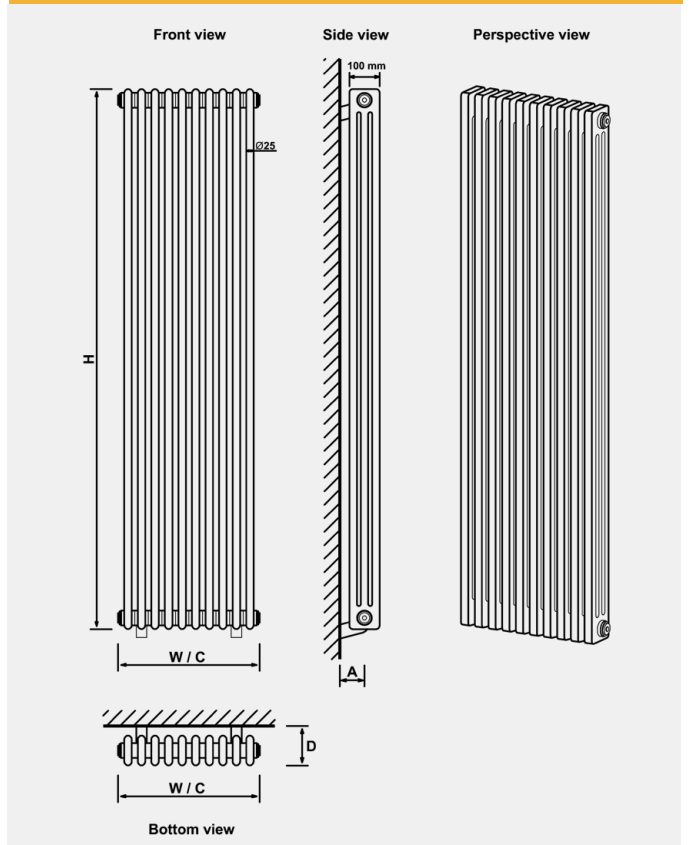

# Technical Tables & Drawings

## RIVASSA - TRADITIONAL RANGE

### Rivassa 4 Column - Horizontal

Height H (mm)	Width W (mm)	Tappings C (mm)	Distance from Wall - D (mm)	Tappings from wall - A (mm)	Tube Qty	Water Content L	Weight KG	Colour	▲T60		Element Output	Element Type
									Watts	BTU		
300	1010	1010	165	95	22	16.20	30.60	Coloured	1197	4085	600W	A, A+, C, E*, H
300	1373	1373	165	95	30	22.20	42.65	Coloured	1633	5573	1000W	A, A+, H
300	1505	1505	165	95	33	24.40	46.10	Coloured	1796	6110	1000W	A+, H
600	425	425	165	95	9	10.80	24.20	Coloured	869	2966	450W	A, A+
600	605	605	165	95	13	15.60	34.20	Coloured	1255	4283	750W	A+, C, H
600	785	785	165	95	17	20.40	43.50	Coloured	1641	5601	900W	A+, H
600	1010	1010	165	95	22	26.40	55.50	Coloured	2124	7249	1200W	A, A+
600	1190	1190	165	95	26	31.20	66.30	Coloured	2510	8567	1200W	A, A+

\*600w Type E Element can be fitted

## LEADON - TRADITIONAL RANGE

### Leadon

Height H (mm)	Width W (mm)	Tappings C (mm)	Distance from Wall - D (mm)	Tappings from wall - A (mm)	Tube Qty	Water Content L	Weight KG	Colour	▲T60		Element Output	Element Type
									Watts	BTU		
940	700	570	260	137	-	9.00	20.20	Chrome	897	3061	450W	A, A+, C, H

## THAMES - TRADITIONAL RANGE

### Thames

Height H (mm)	Width W (mm)	Tappings C (mm)	Distance from Wall - D (mm)	Tappings from wall - A (mm)	Tube Qty	Water Content L	Weight KG	Colour	▲T60		Element Output	Element Type
									Watts	BTU		
1444	630	500	187	150	-	8.70	21.30	Chrome	945	3224	450W	A, A+, C, H

## COLN - TRADITIONAL RANGE

### Coln

Height H (mm)	Width W (mm)	Tappings C (mm)	Distance from Wall - D (mm)	Tappings from wall - A (mm)	Tube Qty	Water Content L	Weight KG	Colour	▲T60		Element Output	Element Type
									Watts	BTU		
510	680	676	260	50	-	5.82	16.30	Chrome	704	2402	300W	A, A+, C, H

\*On dual fuel installation, please use only Type A or Type A+ element

## TWYVER - TRADITIONAL RANGE

### Twyver

Height H (mm)	Width W (mm)	Tappings C (mm)	Distance from Wall - D (mm)	Tappings from wall - A (mm)	Tube Qty	Water Content L	Weight KG	Colour	▲T60		Element Output	Element Type
									Watts	BTU		
952	684	547	158	108	-	3.30	14.60	Chrome	580	1979	N/A	N/A



Rivassa 4 Column  
Horizontal



Leadon



Thames



Coln



Twyver

# Technical Tables & Drawings

## RIVASSA 4 COLUMN HORIZONTAL

Perspective view

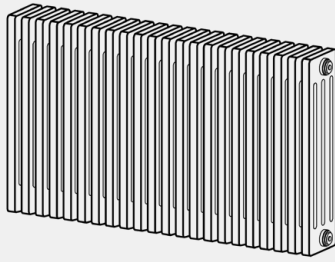

Front view

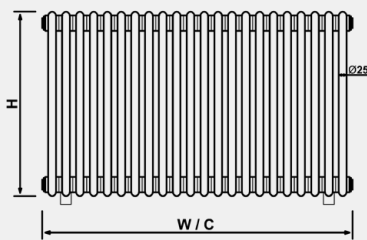

Side view

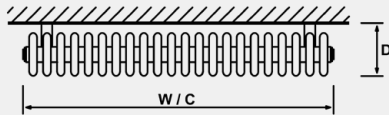
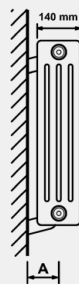

Bottom view

## LEADON

Perspective view

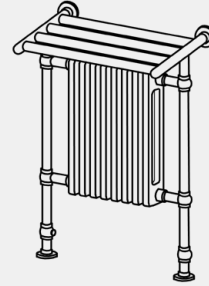

Front view

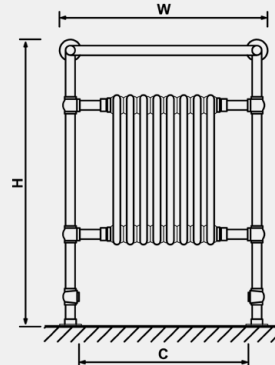

Side view

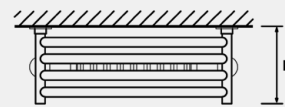
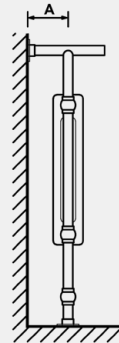

Top view

## THAMES

Perspective view

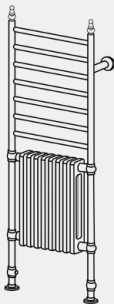

Front view

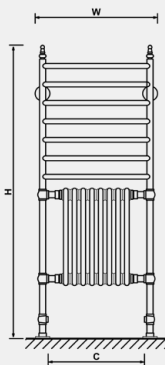

Side view

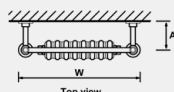
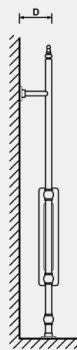

Top view

## COLN

Perspective view

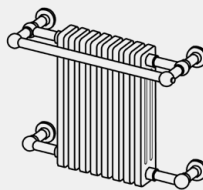

Front view

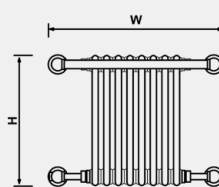

Side view

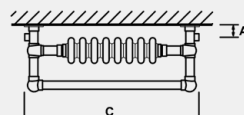
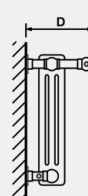

Top view

## TWYVER

Perspective view

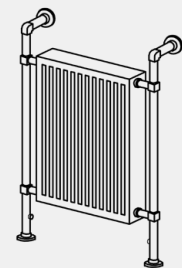

Front view

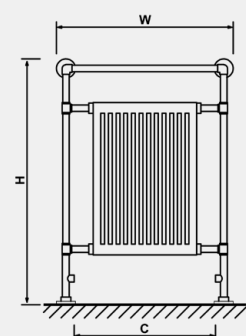

Side view

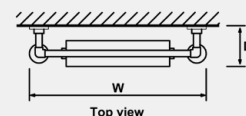
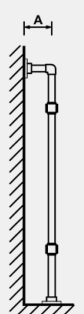

Top view

# Eastbrook Co Terms & Conditions

We deliver all goods on our own dedicated transport fleet to ensure a speedy and problem-free service, however, in the unlikely event that goods are delivered wrong or damaged, it is the responsibility of the customer to ensure sufficient time is allowed for a replacement to be sent.

## 1. DEFINITIONS

In these terms and conditions, the following words shall have the following meanings:

'Buyer' shall mean any person, Eastbrook or company, to whom Eastbrook supplies Goods or Services or with whom Eastbrook enters into negotiations for the supply of Goods or Services.

'Eastbrook' shall mean Brian Michael Douuss and Nicolas Brian Douuss (each a "Partner" together the "Partners") trading as "Eastbrook Co." or "Woodstock".

'Goods' shall mean products, articles or things which are supplied by or which are the subject of negotiations for supply by Eastbrook to the Buyer.

'Services' shall mean services are supplied by or which are the subject of negotiations/ or supply by Eastbrook to the Buyer.

## 2. MAKING THE CONTRACT

Eastbrook's salesmen are not authorised representatives and are not authorised to accept confirm or vary any order nor to make any representation or promise on Eastbrook's behalf

Any estimate/quotation which comprises an invitation to treat is open for a period of 30 days only from the date thereof, provided that Eastbrook has not previously withdrawn it. Any order issued by the Buyer is subject to acceptance by Eastbrook and a contract will only be formed when Eastbrook has accepted the Buyer's offer to buy in writing. Any offer made by the Buyer must be confirmed in writing by the Buyer.

All orders are placed under these terms and conditions alone.

These terms and conditions exclude any other terms and conditions inconsistent therewith which a Buyer might seek to impose even though such other terms and conditions may be submitted in a later document and/or purport to exclude or supersede any terms or conditions with them or may be contained in any offer acceptance or counter-offer made by the Buyer.

No variation of these terms and conditions is permitted unless expressly accepted by a Partner of Eastbrook in writing.

## 3. CANCELLATION

No cancellation by the Buyer is permitted except where expressly agreed by a Partner of Eastbrook in writing.

The Buyer will in the event of agreed cancellation by the Buyer indemnify Eastbrook fully against all expenses incurred up to the time of such cancellation together with by way of liquidated damages a sum of 33 1/3% of the contract price which shall be paid by the Buyer to Eastbrook Forthwith.

## 4. PRICE

All prices quoted are those ruling at the date of dispatch or supply.

Unless otherwise stated all prices quoted are nett, exclusive of VAT, and in the case of Goods ex works.

Eastbrook reserves the right at any time prior to delivery of the Goods or supply of Services to adjust the price to take account of any increase in the cost of raw materials, labour or services or any currency fluctuations affecting the cost of imported materials or services.

## 5. TERMS OF PAYMENT

All sums become due and payable under these terms and conditions not later than 14 days from date of invoice.

Time for payment shall be of the essence.

The Buyer shall have no right to set off, statutory or otherwise.

If the Buyer (being a Company) has a petition for its winding-up or passes a resolution for voluntary winding-up otherwise than for the purpose of a bona fide amalgamation or reconstruction or compounds with its creditors or has a receiver appointed or all or any part of its assets or (being an individual) becomes bankrupt or insolvent or enters into any arrangement with its creditors or commits a material or serious breach of this Agreement (and in the case of such a breach being remediable fails to remedy it within 7 days of receiving notice to do so) he will be deemed to have repudiated the Contract.

Eastbrook reserves the right at any time at its discretion to demand security for payment before continuing with or delivering any Order, supplying any Goods or Services.

## 6. DELIVERY

Delivery will be deemed to have been effected when the Goods are ready for collection at the premises of Eastbrook or as the case may be the premises of the suppliers to Eastbrook in circumstances where the Goods are delivered direct from such suppliers.

Time of delivery is not of the essence.

Eastbrook shall not be liable for any loss whatsoever or howsoever arising caused by its non-delivery or by the failure to make Goods ready for collection on the due date.

Eastbrook reserves the right to make delivery by instalments and to tender a separate invoice in respect of each instalment.

When delivery is to be by instalments or Eastbrook exercises its right to deliver by instalments under clause 6.4 hereof or if there be delay in the delivery of any one or more instalments for whatever reason this will not entitle the Buyer to treat the contract as repudiated and/or to damages.

Deviations in quantity between the Goods delivered and Goods ordered representing not more than 10 per cent by value shall not give the Buyer any right to reject the Goods or to claim damages and the Buyer shall be obliged to accept and pay at the contract rate for the quantity of the Goods delivered.

## 7. SUPPLY OF SERVICES

Time for the supply of Services is not of the essence.

Eastbrook shall not be liable for any loss whatsoever or howsoever arising caused by its failure to supply Services or any part thereof on the due date.

Eastbrook reserves the right to supply Services by instalments and to tender a separate invoice in respect of each instalment.

When the supply of Services is to be by instalments or Eastbrook exercises its right to supply Services by instalments under clause 7.3 hereof or if there be a delay in the supply of any one or more instalments of Services for whatever reason this will not entitle the Buyer to treat the contract as repudiated or to damages.

Deviation in the quantity between Services supplied and the Services ordered representing not more than 10 per cent by value shall not give the Buyer any right to reject the Services or to claim damages and the Buyer shall be obliged to accept and pay at the contract rate for the quantity of the Services supplied.

## 8. RISK AND THE PASSING OF PROPERTY IN GOODS

Risk in the Goods shall pass to the Buyer when the Goods are delivered.

Notwithstanding risk in the Goods passing in accordance with clause 8.1 hereof title in the Goods shall not pass to the Buyer until whichever shall be the first to occur of the following:-

payment being received by Eastbrook for the Goods and Services and no other amounts then being outstanding from the Buyer to Eastbrook in respect of other Goods or Services supplied by Eastbrook

the Buyer selling the Goods in accordance with the provisions of these terms and conditions in which case title to the Goods shall be deemed to have passed to the Buyer immediately prior to delivery of the Goods to the Buyer's customers; and

Eastbrook waiving its rights under this clause 8.2 in respect of specified Goods or Services whereupon title to the said Goods shall forthwith vest in the Buyer.

The Buyer is licensed by Eastbrook to use or to agree to sell the Goods

delivered to the Buyer subject to the express condition that the entire proceeds of any sale are held in trust for Eastbrook and are not mixed with other moneys or paid into an overdraft bank account and shall at all times be identifiable as Eastbrook's moneys.

Until title to the Goods passes:

The Buyer will hold the Goods as fiduciary agent and bailee for Eastbrook;

The Goods shall, subject to clause 8.3, be kept separate and distinct from all other property of the Buyer and of third parties and in good and substantial repair and condition and be stored in such a way as to be clearly identifiable as belonging to Eastbrook;

Eastbrook may at any time revoke the power of sale and use contained in clause 8.3 by notice to the Buyer if the Buyer is in default for longer than 14 days in the payment of any sum whatsoever due to Eastbrook (whether in respect of the Goods or any other Goods or Services supplied at any time by it to the Buyer) or if Eastbrook has bona fide doubts as to the solvency of the Buyer;

The Buyer's power of sale and use contained in clause 8.3 shall automatically cease if the Buyer has a petition presented for its winding-up or passes a resolution for voluntary winding-up otherwise than for the purpose of a bona fide amalgamation or reconstruction or compounds with its creditors or has a receiver appointed of all or any part of its assets or becomes bankrupt or insolvent or enters into any arrangements with creditors or takes or suffers any similar action in consequence of debts or carries out or undergoes any analogous act or proceeding under foreign law;

upon determination of the Buyer's power of sale and use pursuant to clause 8.4.3 or clause 8.4.4, the Buyer shall place any of the Goods in its possession or under its control and unsold at the disposal of Eastbrook and Eastbrook shall be entitled to enter upon any premises of the Buyer for the purpose of removing such Goods.

Eastbrook shall at any time be entitled to appropriate any payments made by the Buyer in respect of any Goods or Services in settlement of such invoices as are due to Eastbrook. Such payments shall be deemed to be made by the Buyer's absolute discretion think fit notwithstanding any purported appropriation to the contrary by the Buyer.

## 9. LIEN AND STOPPAGE

Until such time as the title in the Goods has passed to the Buyer Eastbrook has the right to withhold delivery to the Buyer (being a Company) has a petition presented for its winding-up or passes a resolution for voluntary winding-up otherwise than for the purpose of a bona fide amalgamation or reconstruction or compounds with its creditors or has a receiver appointed or all or any part of its assets or (being an individual) becomes bankrupt or insolvent or enters into any arrangements with creditors or takes or suffers any similar action in consequence of debts or carries out or undergoes any analogous act or proceedings under foreign law.

When the title in the Goods has passed to the Buyer and the time for payment has fallen due but payment has not been made or if the Buyer (being a Company) has a petition presented for its winding-up or passes a resolution for voluntary winding-up otherwise than for the purposes of a bona fide amalgamation or reconstruction or compounds with its creditors or has a receiver appointed of all or any part of its assets or (being an individual) becomes bankrupt or insolvent or enters into any arrangements with creditors or takes or suffers any similar action in consequence of debts or carries out or undergoes any analogous act or proceedings under foreign law Eastbrook has

a lien on the Goods so long as Eastbrook is in possession of them

a right of stoppage in transit

a right of resale

For the avoidance of doubt it is hereby declared that nothing in this clause shall affect the rights given to Eastbrook by ss.38-48 of the Sale of Goods Act 1979.

## 10. INSPECTION/SHORTAGES

The Buyer is under a duty to inspect the Goods forthwith on delivery and satisfy himself as to the due performance of Services forthwith after supply.

Eastbrook shall be under no liability for any defects or shortages that would be apparent on careful inspection if the terms of this clause are not complied with, and, in any event will be under no liability if a written complaint is not made to Eastbrook within 7 days of delivery or supply detailing the alleged defect or shortage.

In all cases where defects or shortages in respect of Goods are complained of Eastbrook shall be under no liability in respect thereof unless an opportunity to inspect the Goods is given to Eastbrook before any use is made thereof or any alteration or modification is made thereto by the Buyer.

Subject to clauses 10.2 and 10.3 Eastbrook shall make good any defect or shortage in the Goods and where appropriate replace any Goods damaged in transit as soon as it is reasonably able to do so, but otherwise shall be under no liability whatsoever or howsoever arising from such defect, shortage or damage.

Subject to clause 10.4 Eastbrook shall remedy any defect in the supply of Services as soon as it is reasonably able to do so but otherwise shall be under no liability whatsoever or howsoever arising from such defect

## 11. WARRANTY

No representation or warranty is given as to the suitability or fitness of the Goods or Services for any particular purpose and the Buyer shall satisfy himself in this respect and shall be totally responsible therefore

If the Goods are in such a state or the Services so defectively supplied as would but for this condition entitle the Buyer to repudiate the contract and/or claim damages from Eastbrook Eastbrook reserves the right to repair or replace the Goods or perform the Services (or the relevant part thereof) again.

## 12. LIABILITY

Introduction

Nothing in this clause 12 shall be deemed to exclude or restrict Eastbrook's liability for death or personal injury resulting from Eastbrook's negligence.

Each of the sub-clauses in this clause 12 is to be treated as separate and independent.

Eastbrook is willing to undertake liability additional to that provided by this clause 12 in exchange for a higher price.

### 12.1 Exclusion

Eastbrook agrees that if any defect caused by faulty design, manufacture, materials or workmanship is discovered during the period of 3 months commencing with the date of delivery or supply, Eastbrook will remedy any defect at its own expense or, in the case of Goods if it chooses to do so, replace them. Defects caused by abnormal use, misuse, neglect or willful or accidental damage are not covered by this clause.

The Buyer cannot claim the benefit of clause 12.2.1 above unless:

he informs Eastbrook of the relevant defect in writing within 7 working days of discovering it; and

in the case of Goods, he returns the Goods to Eastbrook at his own expense.

The risk of accidental loss whilst any Goods are being returned to Eastbrook will be borne by the Buyer.

Notwithstanding clause 12.2.1 above, if the manufacturer of any Goods has provided any guarantee of such Goods for a period longer than three months (a "Manufacturer's Extended Guarantee"), Eastbrook shall use its reasonable endeavours to transfer to the Buyer the benefit of any such Manufacturer's Extended Guarantee in respect of the Goods, provided that Eastbrook may in its absolute discretion elect to do so only at the cost of the Buyer.

Any Manufacturer's Extended Guarantee is for the Buyer only who must complete a return and registration form within 30 days of purchase. Manufacturer's Extended Guarantees are not transferable to third parties and do not cover previously installed products such as ex showroom displays.

Failure to complete and return a registration form to Eastbrook within the 30 day period will result in the guarantee on such Goods being limited to that stated in clause 12.2.1 above.

Manufacturer's Extended Guarantees cover Goods which are used for normal domestic use only and are not applicable to Goods which are used for commercial use (i.e. hotels, residential homes, leisure facilities etc.).

In the event that a manufacturer of Goods providing a Manufacturer's

Extended Guarantee pursuant to clause 12.2.3 above ceases trading and/or no longer honours such guarantee, Eastbrook shall have no liability whatsoever to the Buyer with respect to such Manufacturer's Extended Guarantee.

If the benefit of a Manufacturer's Extended Guarantee is transferred to the Buyer, subject always to clause 12.2.1 above and further subject to the defect not being as a result of fair wear and tear, Eastbrook shall only be liable to provide replacement parts. For the avoidance of doubt, Eastbrook excludes any consequential costs involved in the fitting of such parts. Furthermore, with respect to the following these additional terms are applicable:

Perishable components such as non-glass or metallic parts (e.g. plastic parts, seals, wheels etc.) are excluded from a Manufacturer's Extended Guarantee.

Shower and bath screens: Glass and seals for such products are excluded from a Manufacturer's Extended Guarantee.

Towel rails and radiators: Such products must be individually earthed when installed for a Manufacturer's Extended Guarantee to apply.

If, in the sole opinion of Eastbrook, the Goods which are the subject of the Manufacturer's Extended Guarantee have been modified, misused or neglected or have been willfully or accidentally damaged, Eastbrook shall not be liable under the Manufacturer's Extended Guarantee for the failure of the Goods.

No claim under a Manufacturer's Extended Guarantee will be accepted if Goods have been installed with a fault that would have been clearly visible before installation. A Manufacturer's Extended Guarantee does not cover any Goods which have been modified, altered, transformed or relocated in any way.

Claims under a Manufacturer's Extended Guarantee must be made by the Buyer within [7 working days] of the defect being discovered.

In consideration for receiving the benefit of this clause, the Buyer agrees that, apart from those terms set out in clause 10 and 11, all other terms, whether conditions, warranties or innominate terms, express or implied, statutory or otherwise, are excluded from the contract between Eastbrook and the Buyer to the extent permitted by law (except where the Buyer deals as consumer within section 12 of the Unfair Contract Terms Act 1977 when the terms implied by sections 13, 14 and 15 of the Sale of Goods Act 1979 shall be implied into the contract).

### 12.3 Exclusion of Consequential Loss

Eastbrook shall not be liable for any consequential or indirect loss suffered by the Buyer whether such loss arises from breach of a duty in contract or tort or in any other way (including loss arising from Eastbrook's negligence) including, without limitation to the generality of the foregoing:

- loss of profits;
- loss of contracts;
- damage to property of the Buyer or anyone else; or

personal injury to the Buyer or anyone else (except so far as such injury is attributable to Eastbrook's negligence).

Eastbrook's total liability for any one claim or for the total of all claims arising from any one act or default of Eastbrook (whether arising from Eastbrook's negligence or otherwise) shall not exceed the contract price of the Goods.

## 13. FORCE MAJEURE

Eastbrook shall not be liable for any failure to deliver the Goods or perform the Services arising from circumstances outside Eastbrook's control.

Non-exhaustive illustrations of such circumstances would be act of God, war, riot, explosion, abnormal weather conditions, fire, flood, strikes, lockouts, Government action or regulations (UK or otherwise), delay by suppliers, accidents and shortage of materials, labour or manufacturing facilities.

Should Eastbrook be prevented from delivering the Goods or performing the Services in the above circumstances, it shall give the Buyer written notice of this fact as soon as reasonably practicable after discovering it.

If the circumstances preventing delivery of the Goods or performing the Services are still continuing three months after the Buyer receives Eastbrook's notice, then either party may give written notice to the other cancelling the contract.

If the contract is cancelled in this way, Eastbrook will refund any payment which the Buyer has already made on account of the price (subject to deduction of any amount Eastbrook is entitled to claim from the Buyer) but Eastbrook will not be liable to compensate the Buyer for any further loss or damage caused by the failure to deliver the Goods or perform the Services.

## 14. SALES PROMOTION DOCUMENTATION

Whilst Eastbrook takes every precaution in the preparation of its catalogue, technical circulars, price lists and its other literature, these documents are for the Buyer's general guidance only and the particulars contained therein shall not constitute representations by Eastbrook and Eastbrook shall not be bound thereby.

## 15. USE OF DATA

If the Buyer provides any data relating to the business of the Buyer to Eastbrook for any purpose, then the Buyer agrees that Eastbrook may hold such data and use it in relation to the supply of Goods, to process payment and to inform the Buyer (including all its staff) of other Goods or Services that Eastbrook may offer from time to time. Eastbrook will hold all data relating to the Buyer in accordance with our privacy policy and privacy statements in force from time to time and which is available on demand.

The Buyer agrees that Eastbrook may share any data referred to in clause 15.1 with third parties only where it is necessary for the provision of the Goods or Services such as by Eastbrook and further that the Buyer shall hold Eastbrook harmless for the misuse of such data by those third parties.

In relation to any data supplied by the Buyer to Eastbrook regarding the Buyer's customers, the Buyer warrants and represents that they have obtained consent to share such data with Eastbrook (whether this relates to remedial services or the replacement of Goods or otherwise) and the Buyer agrees to indemnify and keep indemnified, Eastbrook from and against any losses, damages, liability, costs (including legal fees) and expenses incurred by Eastbrook as a result of or in connection with the Buyers' breach of this Clause.

## 16. NOTICES

Any notice to be given hereunder shall be in writing and shall be deemed to have been duly given if sent or delivered to the party concerned at its address specified overleaf or such other address as that party may from time to time notify in writing and shall be deemed to have been served, if sent by post, 48 hours after posting.

## 17. ASSIGNMENT

Neither Eastbrook nor the Buyer shall assign or purport to assign or transfer the contract or the benefits thereof to any other person without prior written consent of the other party.

## 18. SEVERANCE

If any provision of this contract (or part of any provision) is or becomes illegal, invalid or unenforceable, the legality, validity and enforceability of any other provision of the Contract shall not be affected.

If any provision of the contract (or part of any provision) is or becomes illegal, invalid or unenforceable but would be legal, valid and enforceable if some part of it was deleted or modified, the provision or part-provision in question shall apply with such deletions or modifications as may be necessary to make the provision legal, valid and enforceable. In the event of such deletion or modification, the parties shall negotiate in good faith in order to agree the terms of a mutually acceptable alternative provision.

## 19. PROPER LAW AND JURISDICTION

The Contract shall be governed by and construed in accordance with English law and all disputes arising in connection with the contract shall be submitted to the jurisdiction of the English Courts.

## 20. HEADINGS

The headings of these conditions are for convenience only and shall have no effect on the interpretation thereof.



## The RADIATOR COLLECTION 2023/24



 UK Mainland Edition

October 1st - April 30th 2024

### Eastbrook Co.

Eastbrook Road, Gloucester GL4 3DB

Tel: 01452 317800

Fax: 01452 330494

For Sales / Enquiries: [sales@eastbrookco.com](mailto:sales@eastbrookco.com)

For Orders Only: [orders@eastbrookco.com](mailto:orders@eastbrookco.com)

For Technical Enquiries: [technical@eastbrookco.com](mailto:technical@eastbrookco.com)